



Safety Manual

Rev 2.28.2021
Grid Version



Added text for 2021 revisions are shown in bold red italics
*Changed or deleted text for 2021 revisions are denoted by * or by ~~strikethrough~~*

Versant Power

Safety Manual Table of Contents

Added text for 2021 revisions are shown in bold red italics

*Changed or deleted text for 2021 revisions are denoted by * or by ~~strikethrough~~*

Table of contents sections that have been revised during 2021 will be noted with red bold italics.

- i ***Safety Manual Revisions for 2021***
- ii Safety Manual Revisions for 2020
- iii Safety Manual Revisions 9.1.19
- iv Safety Manual Revisions 3.1.19
- v Safety Manual Revisions 1.1.18
- vi Safety Manual Revisions 1.1.17
- vii Safety Manual Revisions 1.1.16

Introduction

Foreword

Occupational Health and Safety

Guiding Principles

Safety Vision Statement

Life Saving Rules

Deviation Protocol

Section 1 Safety Manual Process

1.1 Safety Manual Process

1.2 Definitions

Section 2 Safe Work Practices for All Employees

2.1 Safety Reporting & Notification Process including Attachment 2.1A

- 2.2 Tailboard Briefing and Risk Assessment
- 2.3 Employees Overseeing Work
- 2.4 General
- 2.5 Housekeeping and Fire Protection
- 2.6 In the Office
- 2.7 Ergonomics
- 2.8 Personal Protective Equipment
- 2.9 Tools and Equipment
- 2.10 Fall Protection
- 2.11 Ladders and Scaffolding
- 2.12 Confined Space Entry Policy
- 2.13 Eyewash Stations
- 2.14 Excavation and Trenching

Section 3 Operation of Motor Vehicles and Equipment

- 3.1 Qualifications and Responsibilities
- 3.2 Pre-use Inspection and Maintenance
- 3.3 Backing and Parking
- 3.4 Operating in Traffic
- 3.5 Insulated Aerial Lift
- 3.6 Digger-Derricks
- 3.7 Uninsulated Aerial Lift
- 3.8 Crane Operation
- 3.9 Trailers and Load Securement
- 3.10 Powered Industrial Truck (Forklift)
- 3.11 Special Equipment

Section 4 Communications

- 4.1 Cellular Telephone Use

4.2 Two-Way Radios

Section 5 Transmission and Distribution

5.1 Roles and Responsibilities of T&D Workers (Including Attachment A)

5.2 Working Alone

5.3 Arc Flash (including 5.3A Attachment AF Cheat Sheet)

5.4 Minimum Approach Distances

5.5 Protective Grounding (Including Attachments 5.5B and 5.5C)

5.6 Protective Rubber Goods and Hot-Line Tools

5.7 Working On or Around Energized Equipment

5.8 Poles and Pole Handling

5.9 URD Installations

5.10 Meter Operations

5.11 Substations

5.12 Mobile Substations

5.13 Wire Puller-Tensioners

5.14 Communication Lines

Section 6 Switching and Tagging

6.1 Roles, Responsibilities and Qualifications

6.2 Switching and Tagging Communication

6.3 General

6.4 Work Application Process

6.5 Red Tag

6.6 Yellow Tag

6.7 Blue Tag

6.8 White Tag

6.9 Lockout/Tagout: Electricity under 600 volts and Other Forms of Energy

6.10 Definitions

Section 7 Personal and Environmental Protection

- 7.1 Hazard Communication Program (“HAZCOM”)
- 7.2 Polychlorinated Biphenyls (PCBs)
- 7.3 Asbestos
- 7.4 Acid
- 7.5 Lead Paint

Section 8 Compressed Gasses and Welding

- 8.1 Compressed Gas Cylinders
- 8.2 Welding, Cutting and Brazing

Section 9 Fleet Maintenance

- 9.1 Fleet Maintenance Tools and Equipment
- 9.2 Battery Maintenance

Section 10 Contractor Safety

- 10.1 Contractor and Sub-Contractor Safety

Section 11 First Aid/CPR/Bloodborne Pathogens

- 11.1 First Aid
- 11.2 CPR AED
- 11.3 Bloodborne Pathogen Policy

Section 12 Safe Work Practices

12.1 Safe Work Practices

2021 Safety Manual Revisions

In 2021, all revisions within the year will be detailed in this section. The Revision date is listed as a row item with the specific section and description revisions listed below it. The most recent changes are listed first. Each revision's section column will link to the location in the manual that has been changed.

ALL modifications for 2021: red bold italics for *text additions*, Changed or deleted text will be red bold italic text marked with a ~~strike through~~ or red asterisk *

REVISION DATE: 2 28 2021

Primary Reasons for 2 28 21 revision:

- (1) Addition of Isolated Not Grounded (ING) work rules. These changes primarily affect rules in Section 5 Transmission & Distribution and Section 6 Switching and Tagging. SWP 5.22 Isolated Not Grounded is also listed for reference in Section 12 Safe Work Practices.
- (2) October 2020 NERC audit related changes were made in Section 6 of the Safety Manual. This included use of term "Operating Instructions" to replace "switching and tagging orders" and other similar terms. More specificity has been given to Switching and Tagging Communication

SECTION:	DESCRIPTION:
0.1 Table of Contents	Updated to reflect this revision changes in red text in the Table of Contents
Introduction 1: Foreword	Updated Foreword to reflect new president John Flynn's safety message
1.2 Definitions	<ul style="list-style-type: none"> • Added NERC definition for Bulk Electric System (BES) • Added NERC definition for Element • Added NERC definition for Facility • Added definition for Isolated Not Grounded (ING) • Added definition for NERC • Added definition for Operating Instruction • Added NERC definition for Reliability Coordinator as it pertains to section 6 of this manual. • Added NERC definition for Transmission Operator. • Changed Zone of Clearance or Protection definition to include blue tags as a zone of clearance.
2.1.5 2g i	Added text to use cell phone to call EMS to assist in determining site location
5.2.5 1b viii	Added reference to ING work – NOT allowed when working alone.
5.2.6	Added ING definition
5.5.1	Added text regarding need to use energized work rules if line is not grounded.
5.7.1	Added text regarding need to use energized work rules if line is not grounded.
5.7.5 3 d i	Added this item - Reinforced ING rules that ungrounded conductor must be considered energized and energized work practices and rules apply. Referenced SWP 5.22.
5.7.5 3 d ii	Added this item to clarify that red tags are required for ING work. Details regarding isolation and testing are also provided.
5.7.5 8c	Added text to include requirements for cover-up on ungrounded primary conductor(s) for accidental contact.
6.1.5 2d,e, and 3b	"Switching Instructions" changed to "Operating Instructions"
6.1.5 4c	Added "by recording"
6.1 Attachment A	Deleted this limited diesel switching tagging attachment as there are no more diesel units at the T&D level
6.2.1	Added scope to purpose of where clear communication is essential
6.2.2 2	Added item 2 to reinforce need for 3-part communication for all Operating Instructions.

2021 Safety Manual Revisions

6.2.3 1d	Added item d to include phone communication with CMP (Central Maine Power) & NBP (New Brunswick Power)
6.2.3 2	Added item 2 - three-part communication & Operating Instructions must be in English
6.2.3 3	Added item 3 - three-part communication must use provided nomenclature for elements & facilities
6.2.4 2	Added item 2 to identify miscommunication risk with BES associated with switching & tagging
6.2.5 3	Added this item to specify verbal phone communication with CMP or NBP Energy Control Centers when giving or receiving Operating Instructions
6.2.5 5,5a,5b,5c,6,7, & 8	Replace “message” with “Operating Instructions”
6.2.5 5c	Added details for three-part communication for taking alternative action when a response is not received or understood.
6.3.5 3c ii-iv	Changed “orders” or “switching orders” to “Operating Instructions”
6.3.5 3d iii	Added detail to include System Operations when Central Dispatch is closed.
6.3.2 2	Reinforced that employees are responsible to correctly identify and tag their complete zone of protection.
6.5.2 3	Reinforced that employees are responsible to correctly identify and tag their complete zone of protection.
6.5.5 2g	Added item g to be consistent with 5.7.5 3dii – red tagging details
6.5.5 3cii - iv	Changed “orders” or “switching orders” to “Operating Instructions”
6.5.5 3d iii	Added detail to include System Operations when Central Dispatch is closed.
6.6.5 2d iii	Added item iii to detail change to red tags if an outage occurs during yellow tag work, and the process to return to yellow tag work.
6.6.5 3 cii-iv	Changed “orders” to “Operating Instructions”
6.6.5 3d iii	Added detail to include System Operations when Central Dispatch is closed.
6.7.5 1g, 2b iii-iv	Changed “orders” to “Operating Instructions”
6.7.5 2b v	Changed “grant” to “issue”
6.7.5 2c iii & 2e iii	Added detail to include System Operations when Central Dispatch is closed.
6.10.2	Added text to use definitions in Safety Manual for clarity in understanding
6.10.3	Added note that a definition of Operating Instruction is required per NERC
6.10.6	<ul style="list-style-type: none"> • Added NERC definition for Bulk Electric System (BES) • Added NERC definition for Element • Added NERC definition for Facility • Added definition for Isolated Not Grounded (ING) • Added definition for NERC • Added definition for Operating Instruction • Added NERC definition for Reliability Coordinator as it pertains to section 6 of this manual. • Added NERC definition for Transmission Operator. • Changed Zone of Clearance or Protection definition to include blue tags as a zone of clearance.
12.1.5 1	Added 5.22 ING to list of approved SWPs

2020 Safety Manual Revisions

<p>All revisions within the 2020 year are detailed in this section. The Revision date is listed as a row item with the specific section and description revisions listed below it. The most recent changes will be listed first.</p>	
<p>REVISION DATE: 9.15.2020 – Rebranding</p>	
<p>The primary reason for 9 15 2020 Revision is for rebranding to Versant Power – no changes are noted if strictly for rebranding purposes.</p>	
SECTION:	DESCRIPTION:
2.1 Attachment A	Updated HR contact (T Colbert)
2.7.5 1e	Added reference and link to ergo assessment request
5.1 Attachment A	Updated Line Dept progression document – added definition for Qualified Tag holder and references to same to allow Apprentice thru Second (+) to switch under close supervision of a qualified tag holder (previously needed to be a line worker)
5.5C Attachment C	Updated gnds testing tape colors for 2020-2025
6.8.5 2c&d	Changed white tagging procedure for Versant Power lines being held out of service – no need to pick taps or place grounds; must make line safe. No change for private lines. <i>This was revised on 6/1/2020.</i>
10.1.3 1a i & iv	Updated contractor guidelines to align with 4.30.20 Revision of CSP
12.1.5 1	Updated list of SWP’s available as of 9 15 2020
<p>REVISION DATE: 1.31.2020</p>	
SECTION:	DESCRIPTION:
Table of Contents	Added reference to this section – 2020 Safety Manual Revisions
2.1.2 9	Updated reference to Emera Communications & Reporting procedures to Emera Maine documents – SMS Element 9
2.9.5 2b	Added “using or” to require manufacturers recommendations to be followed when using a tool. From hi potential Corrective Action.
2.9.5 9	Added “Hammer drill” to item to cover both grinders and hammer drills. From hi potential Corrective Action.
2.9.5 9i	Added requirement to use side handles provided with hammer drills or grinders
3.1.5 5	Modified to state that employees cannot consume food while driving. Deleted references to meals and snacks since they are food. . From hi potential Corrective Action.
3.5.5 5c v	Added 3.5.5 5cv - to require testing of boom insulation after a known contact event that caused an arc flash.
6.1.5 3a iii	Removed unused bullet – no informational change.
6.4.5 3ciii	Removed this bullet which required a multi department walk through to confirm established clearances with switching orders on multi-tiered buss work in the NOR. The walk through in the NOR was an OSHA abatement requirement that arose from an arc flash injury. OSHA agreed it was no longer necessary.

Rev 9.1.19 Safety Manual Revisions

For Changes in Revisions 9.1.19 & 9.1.19b	Listed below are changes made for revision issued on 9 1 2019
SECTION 0	
DESCRIPTION	
Intro & Table of Contents	
Table of Contents	Added reference to this section – Rev 9.1.19 Safety Manual Revisions
1 1 2017 Safety Manual Revisions	
Section 5.10 Attachment A	Typo on page 5 of the List of changes for 1.1.17 – “snow” changed to “now”
Foreword	Revised Foreword with Mike Herrin’s signature – <u>this is the only change in Rev 9.1.19 b from 9.1.19</u>
Section 1	
1.2	Added definition for Bonding
1.2	Added definition for Grounding
Section 2	
2.1.5 2ai & 2aii 2.1.5 2 bi & 2bii	Replace System Emergency Manager with Safety on call person for car vs pole and electrical contact incidents involving public
2.1 Attachment A	Updated contact info for injury reporting
Section 3	
3.10.5 1d	Added detail on how long to keep completed forklift inspection pre-use forms.
Section 4 – No changes	
Section 5	
5.3.2 1b	<ul style="list-style-type: none"> - Changed “ report to work wearing base AR clothing” to “with base AR clothing” - deleted requirement to wear base AR clothing when systems are de-energized and grounded - clarified that base AR clothing is must be worn until EPZ is established or during work

Rev 9.1.19 Safety Manual Revisions

	requiring rubber gloves or switching activities.
5.3.2 2e	Deleted “that are providing 2 layers of protection”
5.3.4 2c i	Deleted Bar Harbor from 9 foot arc flash boundary exception.
5.3 AF Cheat Sheet	Deleted Bar Harbor from 9 foot arc flash boundary exception.
5.7.5 4f vii	Clarified rubber glove exception rule with insulated sticks – applies to 34.5 kV and above.
5.7.5 4i	Removed “from the ground” – need rubber gloves on when placing grounds with hot stick
5.7.5 9j	Added rule on when to use Break-Safe Tool or cutout when energizing/de-energizing line.
5.8.5 2d	Changed “near” to “within the MAD zone” for clarity on pole setting
5.8.5 2f	Changed “near” to “within the MAD zone” for clarity on use of rubber gloves with tongs or cant dogs.
Section 6	
6.6.5 3a	Eliminated need to verify bypass fuse or disconnect being opened and locked for yellow tagging
Section 7 – No Changes	
Section 8 – No Changes	
Section 9 – No Changes	
Section 10 – No Changes	
Section 11	
11.3.5 8a ii	Replaced Cidex with Clorox Disinfecting Wipes, deleted “equivalent”
11.3.5 8c vii	Replaced appropriate red bag with garbage bag, and immediate disposal into site dumpster
11.3.5 8c viii	Added details on use of Cintas red bags for washing contaminated Cintas rental clothing
11.3.5 8c ix	Added details on disposal of contaminated PPE to align with 11.3.5 8c vii
Section 12	
12.1.5	Added SWP’s as listed

Rev 3.1.19 Safety Manual Revisions

For Changes in Revision 3.1.19	Listed below are changes made for revision issued on 3.1.2019
SECTION	
DESCRIPTION	
Intro & Table of Contents	
Table of Contents	Added reference to this section – Rev 3.1.19 Safety Manual Revisions
Life Saving Rules	Replaced “ground” with “bond between the two zones”. We are bonding the two potentials into an EPZ with an insulate ground cable.
Section 1	
1.2	<ul style="list-style-type: none"> • Added definition for Composite Utility Pole & reference to FRP • Added definition for Terminal Ground
Section 2	
2.1.5 2a i to iii	<ul style="list-style-type: none"> i Added Central dispatcher and changed person notified to System Emergency Manager (SEM) (defined in SEOP). ii SEM to notify on call safety dept person. iii deleted – line supervisor notification process to be determined by L&M manager
2.1.5 2b i to iii	<ul style="list-style-type: none"> i Added Central dispatcher and changed person notified to System Emergency Manager (SEM) (defined in SEOP). ii SEM to notify on call safety dept person. iii deleted – line supervisor notification process to be determined by L&M manager
2.1.5 2e i	Deleted item i – not required to notify Divisional Line Supervisor for 3Ø Scada trip request.
2.1.5 2f iii	Changed item iii – Deleted requirement for SO to notify divisional supervisor by voice if ETA is greater than 60 minutes. Replaced it with details on contacting incident commander if there is one on scene.
2.1.5 2f iv & v	Deleted items iv, & v. Divisional supervisor guidance not needed if not notified
2.1.5 2g i	Added details regarding using 911 call first as it provides site location – this from hi potential corrective action.
2.1 A Attachment A	Added Jeff Williams contact info to Safety Contacts list.
2.2.5 2b	Inserted new item to acknowledge that different departments can use their own risk assessment forms that aligns with work being performed. Must be approved by Safety Dept
2.6.5 8 f?	Added item under Security to have employee’s visitors sign in & out and wear badges.
2.6.5 8 g?	Added item to have contractors notify VP employee upon arrival when visiting VP facilities
2.8.5 11 a-d	Added rules around who should use V watch voltage detectors, training, and when to wear the detectors

Rev 3.1.19 Safety Manual Revisions

2.8.5 12	Added recommendation around wearing hi vis vest in ROW during hunting season
Section 3	
3.9.4 5	Added oversize, over height loads as a risk – bridge collision
3.9.5 1e	Added loads shall be inspected and measured as part of pre trip inspection – bridge collision
3.9.5 2g	Details of when cargo nets need to used.
Section 4 – No changes	
Section 5	
5.1 Attachment A Line Dept Progression	Updated Attachment A with revision 8-15-2018. This revision details supervision guidelines for pole setting in energized conductors on page 3 of the Attachment.
5.2.5 1c vii	Added details for red tag, tested and grounded for de-energized lines before chain saw use.
5.3.2 1b	Clarified that Base layer (ARC 2) layer must be worn during red tag work if you are inside the potential Arc flash boundary.
5.3.2 2e	Changed i-iv to a thru d to align with numbering scheme in document.
5.3.3 3b	Added “if worn” not necessary to wear undergarments for ARC 2 rating or above. This is aimed at T shirts – they are not needed to reach ARC 2 rating.
5.3.3 3c	Added “do not” to clearly state that undergarments are not required to line up with 5.3.3 3b
5.3.4 1bii	Modified table to not require undergarments see 5.3.3 3c change
5.3.4 1bii	Added text regarding no stickers or decals on undergarments. Also no altering AR undergarments. This lines up with existing 5.3.2 3b language
5.3 A Attachment AF Cheat Sheet	Modified cheat sheet to align with 5.3.4 1bi
5.5.5 1d	Replaced “ground” with “bond between the two zones”. We are bonding the two potentials into an EPZ with an insulate ground cable.
5.5.3 2	Added item 2 regarding Terminal Grounding
5.5.3 3	Modified item 3 to clarify when approved grounds are needed.
5.5.5 2d	Reference Attachment A is changed to Attachment B. Attachment A has been deleted – no longer needed with adoption of terminal grounding
5.5.5 2p	Exception added for terminal grounding – it will be remote from worksite in most cases.
5.5.5 5a & b	Added new item for Terminal Grounding regarding equal potential grounding for 3 wire transmission systems w.o neutral. Added clarity on what needs to be bonded into worksite EPZ
5.5.5 6a	Added clarity on static wire being bonded into EPZ – it is not allowed to be an “approved grounding attachment point” (as previous revision may have inferred)
5.5.5 9f	Changed slide reference to point to underground related slides in Attachment B. New slide additions to Attachment B to cover terminal grounding has changed the order of slides.

Rev 3.1.19 Safety Manual Revisions

5.5.6	Added Terminal Ground definition
5.5A Attachment A	Deleted Attachment A – all information contained in it is now in Attachment B or superseded by Attachment B changes with regard to terminal grounding for 3 phase ckts in the field that do not have neutrals.
5.5 Attachment B	Deleted old slides 3,7,8 & 9 to align with terminal grounding for 3 phase ckts in the field that do not have neutrals. Added slides 8 – 10 to detail transmission grounding with no neutral Added slide 11 to detail glove/stick use when applying grounds Added slide 12 & 13 for tree on line scenarios Added slide 14 for mobile sub grounding guidelines
5.7.5 4g	Added text that doesn't require voltage rated gloves when using extendo stick from the ground provided stick is extended and electrically tested within past 12 months.
5.8.5 1h	Added item h to General practice to reference SWP 7.01 which covers fumigant hazards
5.8.5 1i	Added item i to General practice to reference SWP 5.15 which covers composite poles
5.8.5 2c	Added reference to SWP 5.04 for setting poles in energized conductors
5.8.6	Added definition for Composite Utility Pole
Section 6	
6.1.5 3 ii	Added exceptions as listed to substation equipment being under SO control
6.1 Attachment A 1b i & ii	Deleted Eastport, Young's Corner and Medway from list of diesels
6.3.5 1biii	Added clarity for red tag protection zones. Deleted reference to yellow tagging zone of clearance. This is to align with yellow tag changes.
6.3.5 3c	Changed "prior" to "after"
6.4.5 1a iv	Added exception – no work application for yellow tags on equipment less than 15 kV
6.5.5 3b	Added "known" for clarity
6.6.2 2	Changed "isolating" to "tagging" for clarity
6.6.5 3a	Changed text to clarify that it is not required to isolate all source devices that could energize ckt. This to align with yellow tag changes.
6.6.5 3b	Added "known" for clarity
6.6.5 3g	Reference to section 6.3.5 5 for yellow tag transfer process
6.7.5 1c i	Blue tag shall be changed to a white tag when equipment must remain out of service. (not a red tag as previous version stated)
6.7.5 1f	Added item f to clarify when a blue tag is needed within a red tag zone.
6.7.5 1g	Added item g to allow exercising of disconnects without blue tag under certain conditions.
6.7.5 2c i	Deleted "zone of" and replaced with "required"
6.7.5 2f	Reference to section 6.3.5 5 for blue tag transfer process
6.8.5 1a	Listed exception for use of white tag – when there is ongoing red tag work and red tags are left in

Rev 3.1.19 Safety Manual Revisions

	place.
6.8.5 2c	Clarifies that white tags are used for Versant Power lines or private lines.
6.8.5 2c i2	Adds removal of bottom tap instead of top tap - if greater hazard is created.
Section 7 – No Changes	
Section 8 – No Changes	
Section 9 – No Changes	
Section 10 – No Changes	
Section 11 – No Changes	
Section 12	
12.1.5	Added SWP's 2.03, 2.04, 3.01, 5.10, 5.11, 5.12, 5.13

Rev 1.1.18 Safety Manual Revisions

For Changes in Revision 1.1.18	Listed below are changes made for revision issued on or around 1.1.2018
SECTION	
DESCRIPTION	
Intro & Table of Contents	
Table of Contents	Section 2.1 now listed as Safety Reporting & Notification Process Section 12 will now reference Safe Work Practices (formerly High Risk Tasks) that are located on the grid.
Life Safety Rules	Revised Life Saving Rules to include 3 additional rules to the 3 original rules: 4) EPZ work procedures, 5) Rubber Glove Use rules, & 6) Cover Up rules. These were added as a result of a Hi Potential incident. Added line in introduction to consider employee's skills and intent.
Section 1 – No Changes	
Section 2	
2.1	Added "& Notification Process" to title of section
2.1.1	Added "and includes guidelines for emergency or similar situations"
2.1.2 8	Added this item to reference the new guidelines added in 2.1.5 2
2.1.2 9	Added this item to reference Versant Power Communications & Reporting of Serious Safety Incidents – VP-SMS-PROC_003 – also added document link on grid. This was a corporate requirement.
2.1.4 5	Added this item to list of risks to line up with intent.
2.1.5 2a to g	Added this item and all sub-items to address notification & response to emergency situations. This was a corrective action from a Hi Potential incident.
2.1.5 3	Added this item and all sub-items to define Work stoppage. This was a corrective action from a Hi Potential incident.
2.4.5 2g	Reference to 2.8.5 7a & b regarding when to wear creepers for slip/trip/fall prevention.
2.4.5 5	Added this item to raise awareness when repositioning for work or observation for slip/trip/fall prevention.
2.8.5 4b&c	Modified this item to allow different type of temporary protective footwear and details on when use is allowed.
2.8.5 7b	Changed should to shall for when to wear ice creepers
2.8.5 8ai	Added bullet to include chain saws for when hearing protection is needed. Note this is also referenced in 2.9.5 7d.
2.9.5 7d vi	Removed 5 minute minimum usage for hearing protection on chain saw. If you are using a chain saw you need hearing protection.
2.12.5 6l	PST will maintain confined space entry permits.
Section 3	

Rev 1.1.18 Safety Manual Revisions

3.3.1	Deleted company – backing policy applies to all vehicles not just company vehicles
3.3.2	Added references to company property or works sites
3.4 A Attachment page 6	Modified page 6 of attachment to correct Table 1 Buffer Space to align with MUTCD Rev 2009 Revised May 2012 – distances increased. Modified Table 2 low speed sign spacing to 100 feet (from 200 feet). Added Table 3 for cone spacing information.
3.4 A Attachment page 7-16	Added note to reference Table 3 for cone spacing information
3.4 A Attachment page 8-9	Corrected Taper Length Table to align with MUTCD Rev 2009 Revised May 2012 – distances increased for speeds of 45 MPH and greater.
3.5.2 4	Added item 4 regarding annual requirements for bucket and self-rescue. This is for mechanics that use the bucket during vehicle troubleshooting work.
3.6.5 2d	Added item to allow operation of digger derrick and other equipment without rubber gloves if operator is not in contact with ground or other object with difference in potential.
3.6.5 2j	Added item to state digger tongs are for guides – not lifting
3.10.5 4g	Added item to prevent storage of unsecured material above 8 ft by fork truck (prevent materials from falling)
3.10.5 4h	Added item to keep heaviest side of load closest to fork truck (prevent materials from falling)
Section 4 – No changes	
Section 5	
5.1 Attachment A Line Dept Progression	See Revision page 21 for details of changes to document during 2017.
5.2.5 1cvii	Added item that allowed chain saw use working alone on trees with de-energized lines provided task can be done safely – (stay out of fall zone)
5.2 A Attachment A	Added item to allow removal of branches & small limbs using hot stick by PST
5.3.2 1b	Added item to specify when employees shall wear AR clothing
5.3.2	Changed all references for FR to AR to be consistent with NFPA. Arc Rated clothing is what is needed.
5.3.4 1bii	Updated table to AR from FR (similar to above)
5.3.4 4cii	Added item to allow ARC 2 PPE level for brief inspections inside metal clad units.
5.3.5 1bii	Listed items for clarity regarding restrictions on washing AR clothing
5.3 A Attachment AF Cheat Sheet	Changed any FR references to AR (Arc Rated). Added note to allow ARC-2 in metal clad gear to align with 5.3.4 4cii above. Added note to allow ARC-2 PPE for transformer rated meters of any voltage.
5.5.3 2a-c	Added items to clarify/reinforce the only approved grounding attachment points. Note the order – neutral, existing gnd or driven gnd, last is anchor rod (not rock or ledge anchor)
5.5.5 1a – 1e	Added EPZ Grounding Life Saving Rules

Rev 1.1.18 Safety Manual Revisions

5.5.5 2g	Added line regarding cleaning of clamp jaws on grounding cable prior to attachment
5.5.5 2j	Added item to specifically state guy wires not allowed as grounding point
5.5.5 2o	Inserted item o for guidance on order of attachment of grounds.
5.5.5 3e&f	Deleted the order of for single point grounding attachment details in lieu of 5.5.5 2o guidance.
5.5.5 4d&e	Deleted the order of bracket grounding attachment details in lieu of 5.5.5 2o guidance.
5.5.5 5d&e	Deleted the order of static wires grounding attachment details in lieu of 5.5.5 2o guidance.
5.5.5 8f	Added reference to refer to added pages 15 – 28 in 5.5 Attachment B for URD grounding details
5.5A Attachment A	Corrected text boxes on page 3, 4, & 5 showing Order of Preference for Grounding Connections to align with 5.5.3 2a-c above. Added detail on typical order of grounding page 3. Added detail on page 5 showing all conductors & equipment connected to grounding point for 115kV with static wires.
5.5A Attachment B	Page 8 – removed unneeded grounding cables on right H frame. EPZ on right H frame established with single grounding cable. Page 11 – added note detailing left side grounding cables only needed if more than 1 mile from right side grounds. Page 14 modified to show grounding of running blocks, note on using rubber gloves when operating tensioner, note to brush grounds prior to attachment. Includes arbor ground. Pages 15 to 28 – these pages added to detail URD grounding details.
5.7.5 1	Added Rubber Glove Life Saving Rule
5.7.5 2	Added Protective Cover Up Life Saving Rule
5.7.5 4g	Added need to wear rubber gloves when operating metal clad disconnects/switches
5.7.5 5d iii	Added need to wear rubber sleeves for tails not secured.
5.7.5 7a vii	Added item to specify jumpers must be rated, approved, and tested annually.
5.7.5 7a ix	Added item to allow tape to secure tails temporarily if not used for tagging purposes.
5.7.5 8i	Modified description of when cover up is needed. This statement is basis of Life Saving rule for Cover Up.
5.8.5 2f	Added exception to allow pole handling above 15kV without insulated tongs/cant dog if properly rated gloves are used.
5.8.6	Fixed typo – piking tool
5.11.5 1f	Added item to reference storage of materials/equipment needs to be done in alignment with NESC 110B rule. Request of Insurer.
Section 6	
6.3.5 1b iii	Added details around changing zones of clearance/ protection if new souce of potential introduced.... Result of Hi Potential corrective action
6.3.5 4a ii	Removed statement that allows taping of cut taps – must be mechanically secured for tagging purposes.
6.5.3	Updated photo of red tag to show required fields for placing tag
6.5.5 3b	Added similar statement as 6.3.5 1b iii (above) to red tag section to cover new source of potential being introduced into a tagging zone.
6.5.5 3f iv & iv a	Added tag holder item to clear work on red tag zone cleared prior to re-energizing for 3 phase main lines. Result of Hi Potential corrective action.

Rev 1.1.18 Safety Manual Revisions

6.5.5 3g i&ii	Added SO item to clear work on red tag zone cleared prior to re-energizing for 3 phase main lines. Result of Hi Potential corrective action.
6.5.5 3h iii	Added item to require tag holder to follow protocol on clearing red tag zones prior to energizing if work is being done downstream.
6.6.3	Updated photo of yellow tag to show required fields for placing tag.
6.6.5 3a	Deleted the word “protective” so it now reads “all source devices” instead of “all source protective devices”. Tie switches are not considered “protective” but they need to be tagged.
6.6.5 3b	Added similar statement as 6.3.5 1b iii (above) to yellow tag section to cover new source of potential being introduced into tagging zone
6.6.5 3g	Added text that yellow tags need to be removed at end of each day in addition to reporting “clear”
6.7.3	Updated photo of blue tag to show required fields for placing tag.
6.8.5 2c i2	Added exception that taps don’t need to be removed for white tagging air break switches
Section 7 – No Changes	
Section 8 – No Changes	
Section 9 – No Changes	
Section 10	
10.1.3 1	Added reference to Contractor Safety Plan
10.1.5 1	Added details to who questions should be referred to for contractor safety practices.
10.1A Attachment A	Delete this from manual – it will be part of CSP & modified as needed when CSP is revised.
Section 11	
11.3.5 4a i	Changed to Stock Room employees – they are on the list as having potential exposure.
11.3.5 8 a ii	Added or equivalent to Cidex
11.3.5 8 c ix	Added statement to place ppe in red bag for disposal – current practice.
11.3A Attachment A	Updated Hep B Consent Waiver form for better tracking purposes.
Section 12	
12.1	Add section 1 to reference that these HI Risk Tasks will now be called Safe Work Practices and located on the grid

Rev 1.1.17 Safety Manual Revisions

For Changes in Revision 1.1.17	Below is the list of changes that did occur in the 1.1.17 revision
SECTION	DESCRIPTION
Intro & Table of Contents	
Deviation Protocol	Do not allow deviations from manual during emergencies involving property, equipment or restoration
Section 1	
1.2	Added definition for Armor Rod -used in 5.5 & 5.7
1.2	Changed EBT definition for clarity - EBT as Energy Break Open Threshold - used in 5.3
1.2	Changed definition of De-energized as isolating from electrical source NOT grounded
1.2	Added definition for Hazardous Location use in 2.3 & 2.13
1.2	Added detail to digger derrick definition that states when it does not fall under OSHA crane rules
1.2	Added definition for Immediate area (regarding confined space in 2.10)
1.2	Added definition for junction pole - use in 5.7
1.2	Added definition for Meal as used in Section 3.1.5 regarding distracted driving
1.2	Added definition for Proper Authorization with respect to switching & tagging in 6.5
1.2	Added definition Standard Railing used in 2.4
1.2	Changed Zone of Clearance or Protection definition to not include Blue tags - these are not protection tags
Section 2	
2.1.5 2b	Added employee must confirm supervisor or safety is aware of the injury report
2.1 Attachment A	<ul style="list-style-type: none"> -Added details that any paper copies of injuries must be entered electronically. - Added Details on reporting Severe injuries to OSHA - Added Safety review injuries with HR - Added second sheet with updated contact info & other details
2.2.5 1a	Added Clarity on having at least a daily tailboard - some contractors not doing this.
2.2.5 2g	Changed working on a ladder to 4 feet from 6 feet
2.2.5 2g	Added Loring to Underground
2.2.5 2g	Added shopwork

Rev 1.1.17 Safety Manual Revisions

2.2.5 2g	Changed substation alarm reset to substation alarm troubleshooting
2.2.5 2g	Added when entering a ROW on foot on by vehicle
2.2.5 2h	Added roadside to patrolling
2.3.6	Added definition of Hazardous condition as used in 2.3.5 4d
2.4.6	Added definition of Standard Railing as used in 2.4.5 5e
2.5.5 1c v	Added eyewash stations
2.5.5 1i	Changed around to in front of
2.7.5 3a	Changed shall to should regarding stretch breaks
2.8.5 6b	Added details on when cut & puncture resistant gloves are required - handling glass & metal/wire. Other changes around use of cut & puncture res gloves in 5.10.5 3 i to iv & 11.3.5 7a i
2.9.5 2c	Added details around gray tagging defective tools or equipment
2.9.5 5a	Added text to prevent modification of extension cords.
2.9.5 7e iii	Changed to define proper way to start saw from bucket. "Drop Starting" is no longer allowed per OSHA
2.9.6	Added definition of Qualified - used in 2.9.5 7b
2.10.5 4d iii	Added line for 100% tie off, employees need transition lanyard
2.11.2 2	Added scaffolding
2.11.4 4	Added risk of electrical contact
2.11.5 1c	Added "gray" to tagged out of service
2.11.5 1m	Added unless it is designed by manufacturer more than 1 person - double sided ladders
2.11.5 5d	Added details for when toe boards needed
2.12.5 2c	Changed four to five feet when ladder should be used to enter confined space
2.12.5 4b ix	Added detail on OSHA requirement to maintain communication with rescue services
2.12.5 5 a	Added detail on OSHA requirement to practice rescue annually
2.12.5 5 e	Added detail on OSHA requirement for contracted rescue service to give notice if unavailable
2.12.5 6d	Added detail for OSHA requirement to bump test monitor with cal gas before use
2.12.5 7d	Added detail for OSHA requirement company is responsible to ensure workers outside confined space to not create hazards inside space
2.12.6	Added definition for Immediate area
2.12 Attachment A	Identified mandatory devices on checklist with Asterisk. Added check box for Rescue Service contacted and contact info for same. Did not mark these in Red on form
2.14.5 2h	Added language about securing poles when trenching. Also added to 5.8.5 2b

Rev 1.1.17 Safety Manual Revisions

Section 3	
3.1.5 5	Added details regarding eating & driving
3.1.6	Added definition of meal
3.2.5 8c	Added: "Vehicle is free of all debris & all items are secured"
3.3.5 1a	Added exception to backing for angled parking
3.3.5 1b iv	Added reference to include use of back up camera if available
3.3.5 1h	Changed - Removed reference to Company backing policy - now integrated into this section of Safety Manual
3.3.5 2e	Changed safety to safely - typo
3.3.5 2g i	Changed description of when chocks required for trucks
3.3.5 2g ii	Added chock requirement for Class C squirt boom trucks when boom or bucket in air
3.5.4 6	Added Inclement weather to risks while working aloft
3.5.5 3c	Added allowance for positioning or cleaning
3.5.5 3d	Changed material handler to jib
3.5.5 4g	Changed shall to should regarding bucket entry
3.5.5 4p	Added weather condition consideration
3.5.5 5b	Added leased for equipment
3.6.5 2d	Added "are in the mad zone"
3.6.5 2h	Changed shall to should
3.6.6	Added detail to digger derrick definition that states when it does not fall under OSHA crane rules
3.8.5 1n	Changed item n and added I thru iv to align with 1926.1408(a) & (b). Used to say within a boom's length
3.11.5 1f	Added details on using spotter for special equipment
3.11.5 1g	Added details on first aid equipment on board special equipment
Section 4	
4.2 Attachment A	Revised Attachment A - Ch 35 now linked and not dedicated to meters
Section 5	
5.1 Attachment A	Progression document revised as of 6 15 16. Inserted page numbers
5.3.2 2	Added details 5.3.2 2a thru g on wearing of AR clothing

Rev 1.1.17 Safety Manual Revisions

5.3.2 3b	Added details disallowing labels or decals on non FR t shirts and not modifying FR t shirts
5.3.2 4 a	Changed - typo rain suites to rain suits
5.3.4 1	Added "including 40 Cal hood" to ARC 4 PPE Category in table
5.3.4 2a i	Added "exposed" for clarity
5.3.6	Changed EBT definition for clarity
5.3 Attachment A	Changed/Revised Cheat sheet to include 40 cal hood in ARC 4 PPE & to include Glove Class Chart
5.4.5 4d	Changed policy to protocol and described location in manual
5.5.3 1	Added detail to ground sizes for SOR/NOR overhead & underground
5.5.5 1f	Added grounds testing requirement & reference to Attachment C
5.5.5 1n	Added 15 foot distance from grounding electrode installed for EPZ
5.5.5 5c	Added preference for voltage test at class to be tested
5.5.5 6f	Added line for trailers & equipment in substation fence shall be connected to ground grid
5.5.5 7	Added 5.5.7 to detail URD grounding requirements
5.5.6	Added Armor Rod definition
5.5 Attachment B	Added 5.5 Attachment B to detail EPZ grounding sketches from training
5.5 Attachment C	Added 5.5 Attachment C for Grounds testing details
5.6.5 5d	Added "hard" to specify hard cover testing not required
5.7.4 4	Added Electrical contact due to high winds when operating aloft to Risks
5.7.5 1 c vi	Added reference to location of deviation protocol
5.7.5 2a	Added that gloves are used they must be rated for appropriate voltage
5.7.5 2f ii	Added cut resistant gloves needed when changing bulbs (intent to protect from glass breakage)
5.7.5 2h	Added Exception for rubber glove use when coupling/decoupling operator from mot switch
5.7.5 2l	Added reference to glove chart in 5.7.5 2p
5.7.5 2o	Added "overhead" for primary conductor to clarify
5.7.5 2p	Added detail for rubber glove use with underground primary cable. Included glove class table here
5.7.5 4c	Changed Section reference from 5.6 to 5.4
5.7.5 4d	Changed shall to should for hot line use - with long extensions this can be very difficult
5.7.5 6f	Changed from below to lineman's eye level to reduce reaching when possible
5.7.6	Added armor rod definition - used in this section
5.7.6	Added junction pole definition for use of rubber sleeves

Rev 1.1.17 Safety Manual Revisions

5.8.5 2b	Added line requiring poles to be supported when soil disturbed - similar statement in 2.14.5 2g
5.8.5 2 c	Added clarity if pole or digger in mad zone
5.8.5 2 d	Changed to add clarity for yellow tag requirement if at or over 19.9 kV. This to be consistent with 6.6
5.8.5 2 e	Changed to require rubber gloves without regard to voltage - deleted "up to 15kV"
5.8.5 2 f	Added need to use rubber gloves even if using tongs or cant dogs
5.9.5 1d vi	Changed to refer to Deviation protocol and lists location of same
5.9.5 3b	Changed to refer to Deviation protocol and lists location of same
5.9.5 3c	Added rubber glove exception for a new URD cable installation yet to be connected.
5.9.5 3e	Added- placed reference for URD with concentric neutral here
5.9.5 3f	Changed - deleted reference for URD concentric neutral here, now f becomes old g
5.10.3 e	Added details to check for cross phase parallel conductors
5.10.3 j v	Changed - removed broken so now cut proof gloves used when handling glass - broken or not.
5.10 attachment A	Changed - page 4 now reads 200 amps not 400
5.11.5 1f iii	Added reference to foot protection section 2.8.5 4
5.11.5 3d	Added detail for adequate ventilation per OSHA for battery rooms
Section 6	
6.3.5 1b iv	Added tagholder's designate
6.3.5 4a ii	Added detail when taping is acceptable for securing taps
6.5.3 5	Updated photo of red tag to one currently in use
6.5.5 4	Added red tag clarity for URD ground switch movement
6.6.3 5	Updated photo of yellow tag to one currently in use
6.6.5 2a & 2b ii	Changed a & b to be in alignment with not needing yellow tags for pole placing below 19.9/34.5 kV - our current practice
6.7.3.5	Changed text on blue tag to remove "protection" reference. Red tag is only protection tag. Update photo to new tag
6.8.3 5	Enlarged picture of white tag
6.8.5 1h	Changed Divisional Supervisor to Central Dispatch – SO & Central dispatch will maintain & publish white tag database. Change made 1/4/17
6.8.5 2d	Added exception for white tag tap removal & grounding requirement for certain seasonal disconnects. Change made 1/4/17
6.9.3 5	Enlarged picture of Lock out tag
6.10.6	Changed definition of De-energized as isolating from electrical source NOT grounded

Rev 1.1.17 Safety Manual Revisions

6.10.6	Added definition of proper authorization
6.10.6	Changed Zone of Clearance or Protection to not include Blue tags
Section 7 - NO Changes	
Section 8	
8.1.5 2 iv	Change - removed FR clothing reference & replaced with reference to section 8.2.4 for cutting & welding
8.2.5 2b	Added reference to a hot work checklist available on the grid - per insurance carrier request
8.2.5 2e i	Change - Removed exemption for mandatory fire watch if auto fire suppression is in place - per Insurance carrier request
8.2.5 3c	Added reference to OSHA details for ventilation
Section 9	
9.2.5 3e	Changed - Insulated not insulated
9.2.5 3f	Changed -more details on adding water to battery cells
Section 10	
10.1 Attachment A	Changed - For contractors - removed face protection requirement for chain saw & reference chainsaw guidelines in 1910.266
Section 11	
11.1.5 1b	Changed GO Team to Stock room employees first bullet, added Safety Employees to 4 th bullet, added employees to 5 th bullet
11.1.5 4a	Changed bacitracin to triple antibiotic ointment.
11.1.6	Changed - deleted Go Team from definitions
11.2.5 1 i thru v	Changed - Go Team to Stock room employees for i, added Safety lab for iv, added employees for v
11.2.6	Changed - deleted Go Team from definitions
11.3.5 4a	Changed – deleted GO Team for i, added Safety Employees to iv, added employees to v

Rev 1.1.16 Safety Manual Revisions

There have been a number of modifications to the Manual after it was printed and distributed in July. Following is a list of the revised sections including a brief description of the revisions.

1. Table of Contents: corrected section numbering and added Section 6.8 White Tag
2. Introduction:
 - a. Providing the Occupational Health and Safety Statement.
 - b. Life Saving Rules – amended to include the life saving rules from Sections 2.10 and 2.12 for quick reference.
3. Section 1.2: “critical lift” and “authorized attendant” definitions corrected.
4. Section 2.8: revised safety glasses safe work practices (2.8.5.3)
5. Section 2.12: “authorized attendant” definition corrected and added “immediate area” to 2.12.5.4.b.v.
6. Section 2.14: grammatical error corrected in 2.14.3.3
7. Section 3.6: wording change “shall” to “should” in 3.6.5.2.f and inserted 3.6.5.1.d digger-derrick is not considered insulated until the upper boom is extended.
8. Section 3.8: “critical lift” definition corrected, added new Attachment A for prescribed hand signals and amended section to include attachment reference.
9. Section 3.10: revised 3.10.5.3.j to include new order picker lift at Hampden Operations Center (HOC) and revised 3.10.5.3.e as a result of a near miss incident.
10. Section 4.2: revised Attachment A to include new radio channels.
11. Section 5.1: revised Attachment A to include complete line progression document.
12. Section 5.2: added new Attachment A for qualified Power System Technicians (PST) work roles and revised section to include attachment reference.
13. Section 5.5: revised 5.5.5.6.d.iii to read one ground rod instead of two and revised order of grounding for structures with static wires.
14. Section 5.7: removed exception 5.7.5.2.f.vii which should not have been included, revised 5.7.5.3.d for clarification that sleeves are for use with primary voltage conductors, revised 5.7.5.6.i to include the neutral in the list of items requiring cover up, and removed 5.7.5.5.d.v as it is more procedural than a safe work practice.
15. Section 5.9: revised 5.9.5.1.d to include tagging language, changed wording in 5.9.5.4.b from “directly attended” to “attended” and added exceptions to rubber glove use in 5.9.5.3.
16. Section 5.10: revised 5.10.5.1.i to reflect the change which requires safety glasses to be worn while in the meter shop and amended 5.10.5.3 and 5.10.5.4 to strengthen the requirement to test meters before installation as a result of Hazardous Condition Near Miss (HCNM) events.
17. Section 5.11: revised 5.11.5.1.k and 5.11.5.4.d for clarity and added 5.11.5.4 to provide the safe work practice for SF6 breakers.
18. Section 6: updated entire section to accommodate Section 6.8 White Tag which will be provided in 2016.
19. Section 8.1: revised 8.1.5.4.e from “shall” to “should”.
20. Section 9.1: grammatical correction in 9.1.5.1.b and amended the exhaust ventilation language in 9.1.5.5.a.
21. Section 9.2: revised 9.2.5.2.a to include required PPE.



At Versant Power, nothing is more important than safety.

This Safety Manual is without doubt one of the most important documents here at Versant Power. There is simply nothing more important than ensuring that each and every one of us complete our workday and return home to our families safely – every day.

This Manual provides clear guidance on how to properly complete our work without injury. It reflects our safety policies and the industry's best practices. It was developed with input from subject matter experts across the entire company. It has the full support of the executive leadership team.

The information in this Manual can prevent injury and could save your life or that of a coworker, customer, or a member of the general public. For this Manual to be effective, we all need to do more than just read it – we need to take on board the information contained herein and ensure that we put that into practice every day. I strongly recommend that you actively discuss this with your supervisor and your coworkers. If you have questions – please ask; if you have recommendations for improvement – please suggest them to your supervisor or directly to Stan Hartin.

Before we begin any job, we need to ensure that we understand all the steps that need to be taken so that we can execute the job safely. If there are any questions or concerns, I encourage you to consult the safety manual and, as necessary, your supervisor before you begin the job. The manual is just that – a manual.

Sincerely,

A handwritten signature in black ink that reads "John Flynn". The signature is written in a cursive, flowing style.

*John Flynn
President*



OCCUPATIONAL HEALTH AND SAFETY

The occupational health and safety of people is more important than any business interest. For this reason, occupational health and safety is our core value.

To this end:

- Versant Power is committed to providing a healthy and safe work environment for all employees and contractors on its sites.
- Versant Power endeavors to protect the general public against health or safety risks arising from its business activities.
- Versant Power believes that all occupational injuries and illnesses are preventable, that safety must be an integral part of every job and that planning, equipment and appropriate personal behavior will yield workplace conditions that are injury-free.
- Versant Power is committed to identifying and developing best practices to promote ongoing improvement of health and safety in every job.
- Workplace conditions will meet or exceed all applicable regulatory requirements.
- At Versant Power, we believe that safety is a shared responsibility. Accordingly, all employees accept personal responsibility for proper use of procedures and equipment provided for their protection and encourages similar behavior among co-workers and people working under their direction.
- Versant Power encourages health and safety efforts beyond the workplace by recognizing and supporting health and safety outside the normal work day.
- Versant Power provides an environment that enables all employees to participate and work collaboratively in developing, promoting and improving health and safety.
- All employees are responsible for contributing to our success in ensuring a healthy and safe work environment by knowing and following our safety procedures and promptly reporting safety concerns, suggestions, violations and accidents or injuries.

Guiding Principles



SAFETY

We have an unyielding commitment to safety. Safety guides our behavior, decisions, and actions. We believe every employee has a responsibility to be a leader in safety at work, home and in the community.

RELENTLESS DRIVE TO QUALITY RESULTS

Our reputation should leave no room for doubt when we say something can be done or will be done. We will not compromise safety in achieving quality results. We recognize the difference between best effort with poor results as opposed to poor results from lack of effort or sloppiness.

ACCOUNTABILITY

We take responsibility for the commitments we make to our customers, our shareholders, and our co-workers; and for our actions in fulfilling these commitments. We take seriously our responsibility to be good stewards of the environment and use our resources wisely.

INTEGRITY AND RESPECT

We believe honest, respectful relationships and trust are essential for long-term business success. We deal respectfully and with integrity in all our business relations. We maintain our credibility by always making sure our actions match our words. We do the right thing even when no one is looking.

CREATIVITY AND INNOVATION

We believe in continuously improving what we do and how we do it. We challenge conventional thinking and encourage creativity and innovation to find mutually beneficial solutions. We embrace change for the opportunities it offers.

Safety Vision Statement

“Versant Power is a company where safety is our core value. We are committed to our own safety and that of each other.”

OPEN COMMUNICATION

We foster an open environment where everyone is empowered to discuss safety concerns, issues, ideas, and accomplishments without fear of retribution

PERSONAL CHOICE

We do it right; working safely, taking no shortcuts, and regrouping; even if that means a delay in work

COMMITMENT

We identify risks and exposures and choose best practices to ensure the safety of ourselves, our coworkers and the public

TRAINING

We are committed to supporting, delivering, receiving and applying training that enhances the safety and wellness of all employees

SELF RESPONSIBILITY

When it comes to safety we lead by example

Life Saving Rules

The Company's mandatory Life Saving Rules reinforce what employees must know to prevent serious injury or fatality. If any of these rules must be broken to complete a task, employees shall not complete the task. An employee who violates any of these rules shall face disciplinary action up to termination of employment. The employee's skills and intent will be considered.

1. Employees shall not remove a Red Tag or operate a switch, disconnect or breaker which bears a Red Tag without proper authorization.
2. Employees shall not violate the Life Saving Rules specified in the Company's Fall Protection Safe Work Practices (Section 2.10):
 - a. Employees shall use fall protection when working more than four feet above a lower level for the following conditions:
 - i. when in an aerial lift unit
 - ii. when standing on substation structures and equipment
 - iii. when climbing and working from a pole
3. Employees shall not violate the Life Saving Rules specified in the Company's Confined Space Safe Work Practices (Section 2.12):
 - a. Do not enter a confined space until an entry permit has been completed.
 - b. The attendant shall not leave the immediate area of the confined space while it is occupied.
 - c. An air monitor shall be located in the confined space at all times while it is occupied.
 - d. Entrants shall wear rescue harness at all times.
 - e. Rescue Equipment shall be in place at all times.
4. Employees shall not violate the Equipotential Zone (EPZ) Grounding Life Saving Rules specified for work procedures required for de-energized work specified in Protective Grounding (Section 5.5):
 - a. Guy wires cannot be used as a grounding point.
 - b. All conductors and clamp heads must be wire brushed prior to attaching grounds.
 - c. Cluster bars must be used on poles when required.
 - d. When all conductors are broken & separated, the first connection to establish an EPZ between the two potentials requires a bond to be installed using an insulated stick and rubber gloves.
 - e. Rubber gloves must be used when handling a conductor on the ground.
5. Employees shall not violate the Rubber Glove Life Saving rules as specified in Working On or Around Energized Equipment (Section 5.7):
 - a. Properly rated rubber gloves shall be used when working on energized conductors.(Exceptions as noted in section 5.7.5)
6. Employees shall not violate the Protective Cover Up use rules as specified in Working On or Around Energized Equipment (Section 5.7):
 - a. If working within the MAD (Minimum Approach Distance) zone, the energized conductor(s) must be covered. When working on energized conductors, anything at a different potential within reaching distance of the worker - neutral, grounded conductors, guy wires, messenger cables, potential grounds, and pole, etc. shall have approved protective cover-up devices installed.

Deviation Protocol

The Safe Work Practices contained in this Safety Manual are intended to provide employees with the direction and guidance necessary to ensure a safe work environment. Deviation from the safety manual shall not be allowed for emergency situations involving property, equipment or outage restoration.

Versant Power recognizes that practices and rules cannot be crafted for all circumstances. Employees may encounter circumstances where guidance has not been provided or exceptional conditions arise that require the use of an alternate method other than what is permitted in the existing practice or rule.

For circumstances where a practice or rule has not been provided, employees should ask for guidance from their co-workers, lead workers or their supervisor. Experience and training should guide the employee in making decisions that best protect employees, customers and the public. All decisions shall comply with applicable laws and regulations.

For circumstances where an employee believes Safe Work Practices conflict with or are less safe than the alternate method, an employee may request a deviation from the existing rules by observing the following:

- 1) If the work practice requires violation of a Life Saving Rule, the work shall not be completed. Risks associated with violating these rules are unacceptable.
- 2) For circumstances requiring deviation from an existing practice or rule, the employee shall contact their supervisor or department manager.
- 3) The employee shall explain the situation, risks and consequences of using the existing practice or rule and ask for permission to deviate from this practice or rule.
- 4) The supervisor or department manager shall review the deviation request with the Safety Department.
- 5) Once permission has been granted and all employees involved are in agreement, the employee shall document the task in a detailed Risk Assessment and then complete the task.
- 6) The Risk Assessment shall be submitted to the Manager of Safety who shall initiate a review of the deviation.
- 7) Deviation request is "one time only". The deviation protocol must be observed for each subsequent circumstance.
- 8) Due diligence shall be followed throughout the process. The safety of our employees shall take precedence over production.

Deviation from any Safe Work Practice is always a last resort and should only be engaged in after all other avenues are exhausted.

Section 1	Safety Manual Process	
1.1	Safety Manual Process	Effective Date: 1/1/2016 Revised:
1.1.1 Purpose	The Safety Manual is an essential part of Versant Power’s (“the Company”) overall commitment to a safe work environment. It is intended that these safe work practices meet or exceed the requirements of all applicable federal and state laws and regulations. The purpose of this section is to outline a process for maintaining a current and up-to-date safety manual.	
1.1.2 Responsibilities	<ol style="list-style-type: none"> 1. The Company is responsible for providing oversight, guidance and resources to aid in the development and implementation of this Safety Manual. 2. The Company is responsible for ensuring that all employees are provided with a copy of this Safety Manual. 3. The Safety Department is responsible for facilitating applicable training to all employees on this Safety Manual. 4. The Safety Department is responsible for coordinating Safety Manual revisions and distributions with the Safety Manual Review Sub-Team. 5. Employees are responsible for complying with the safe work practices within this Safety Manual. 	
1.1.3 Requirements	<ol style="list-style-type: none"> 1. A paper copy of the Safety Manual for each employee. 2. A signed employee issuance form. 3. A current electronic copy of the Safety Manual on the Grid. 4. Safety Manual Review Sub-team for review and revisions. 	
1.1.4 Risk Identification	<ol style="list-style-type: none"> 1. Safety Manual update process not being followed. 2. The Safety Manual becoming outdated. 	
1.1.5 Safe Work Practices	<ol style="list-style-type: none"> 1. Safety Manual Format <ol style="list-style-type: none"> a. The format of the Versant Power Employee Safety Manual shall be “Information Mapping”. b. The Information Mapping layout of each section shall be as follows: <ol style="list-style-type: none"> i. Section Title ii. Sub-sections (e.g. 5.1, 5.2, 5.3) iii. Each sub-section: <ul style="list-style-type: none"> ➤ Purpose ➤ Responsibilities ➤ Requirements ➤ Risk Identification ➤ Safe Work Practices ➤ Definitions 	

	<p>2. Employee Safety Manual Issuance</p> <ul style="list-style-type: none"> a. All employees shall be issued a paper copy of the Safety Manual during their new-hire orientation. b. All employees shall sign a Safety Manual Issuance form that indicates they have received a copy of the Safety Manual. c. Safety Manual Issuance forms shall be maintained by the Human Resources Department in the respective employee’s file. d. The Safety Manual shall be reprinted and distributed to all employees at least once every five years. e. Supervisors shall ensure that all updated or revised materials are distributed and all obsolete copies are destroyed. <p>3. Safety Manual Revisions</p> <ul style="list-style-type: none"> a. The Safety Manual Review Sub-Team shall work with the Safety Department to review, update and issue revisions as necessary. b. Employees that are aware of any changes to federal or state laws or regulations that may affect the Safety Manual shall communicate those changes to the Safety Department. c. Employees shall communicate suggested changes to the safe work practices to the Safety Department for consideration. d. Employees should utilize the on-line Safety Suggestion Form for communicating suggested changes. http://intra.bhe.com/resources/IncidentReporting/Incidents.cfm?report=1&reporttype=8 <p>4. Document Control</p> <ul style="list-style-type: none"> a. All sections of the Safety Manual shall be issued with an effective and revised date. b. The Safety Department shall maintain the Master Document and a record of all revisions.
<p>1.1.6 Definitions</p>	<p>Information Mapping: a writing technique that divides and labels information in a document to facilitate comprehension, use and recall.</p> <p>Safety Manual Review Sub-Team: a sub-team of the Employee Safety Team with the primary purpose of reviewing and recommending changes to the Safety Manual.</p>

Acetylene: a colorless gas widely used in metal cutting operations.

Acid: any chemical substance with a pH lower than 7.

AED: Automated External Defibrillator

AMR: automatic meter reading

Anchorage: a secure point of attachment for lifelines, lanyards and/or deceleration devices.

ANSI: American National Standards Institute

Apparatus: all equipment pertaining to the generation, transmission, distribution and use of electric power.

Apparatus Covered: all apparatus which is covered by a tag of a distinctive color.

Apparatus Isolated: all apparatus which is disconnected from sources of dynamic power by means of a recognized isolating device.

Applicant: a qualified person who is applying for a tag, or tags, to obtain protection or clearance on electrical equipment or apparatus. The term embraces all types of tags.

Arc: Versant Power's Arc Rating Categories.

ARC-1 0 – 5.0 Calories/CM²

ARC-2 5.001-8.0 Calories/CM²

ARC-3 8.001-20.0 Calories/CM²

ARC-4 20.001-40.0 Calories/CM²

Suffix – F Requires 20 Calorie Face shield

Suffix – B Requires 20 Calorie Balaclava

Arc Flash: a rapid, explosive discharge of electrical energy that usually results from a short circuit. Short circuits are caused by flashover of electric current through air between live parts or from live parts to ground. Dielectric of air: (1 inch = 10 Kv).

Arc Flash Boundary: if an arc flash occurred, this boundary is where an employee would be exposed to a curable second degree burn (IE of 1.2 calories/cm²). Note: The Arc Flash Boundary that will be used for T&D Lines will be equivalent to the applicable MAD (Minimum Approach Distance) as calculated by Engineering for the nominal voltage of the specific Line. At the MAD for T&D Lines, the IE will be no greater than 2 calories/cm².

Arc Flash Hazard: the danger of excessive heat exposure and serious burn injury due to arcing faults in electrical power systems. Note: An arc flash hazard may exist when energized electrical conductors or circuit parts are exposed or when they are within equipment in a guarded or enclosed condition, provided a person is interacting with the equipment in such a manner that could cause an electric arc. Under normal operating conditions, enclosed energized equipment that has been properly installed and maintained is not likely to pose an arc flash hazard.

Arc Rod: Stranded preformed wire rods that are wrapped on existing conductors & designed to protect cable against bending, compression, abrasion, and flash-over. They are also used to repair damaged aluminum-based conductors and restore the conductors' mechanical strength and conductivity.

Arc Flash Hazard Assessment: a study investigating a worker's potential exposure to arc-flash energy, conducted for the purpose of injury prevention and the determination of safe work practices and the appropriate levels of PPE.

Arc Rating (AR): the value attributed to materials that describe their performance to exposure to an electric arc discharge. The arc rating is expressed in cal/cm² and is derived from the determined value of the arc thermal performance value (ATPV) or break open threshold (EBT) in the event the material exhibits a break open response at a value below the ATPV value.

Arc Thermal Performance Value (ATPV): the incident energy on a material or multilayer system of material that results in a 50% probability that sufficient heat transfer through the material is predicted to cause the onset of a second degree skin burn injury. **Used in conjunction with break open threshold (EBT) to derive Arc Rating (AR) Cal/Cm² of material.**

Asbestos: includes chrysotile, amosite, crocidolite, tremolite asbestos, anthophyllite asbestos, actinolite asbestos, and any of these minerals that has been chemically treated and/or altered.

Asbestos Containing Materials (ACM): any material containing more than one percent asbestos.

Asphyxiation: to prevent breathing.

ASTM: ASTM International, an organization that sets materials standards.

ATV: All-Terrain Vehicle.

Authorized Attendant: an individual stationed outside one or more confined spaces who monitors the authorized entrants and who performs all attendant's duties. An Authorized Attendant also may serve as an Authorized Entrant or Entry Supervisor. An Authorized Attendant shall never serve simultaneously as an Entrant.

Authorized Entrant: an employee who is authorized by the employer to enter a confined space. An Authorized Entrant may also serve as an Attendant or as an Entry Supervisor.

Barricade: a physical obstruction such as tape, screens, or cones intended to warn and limit access to a hazardous area.

Blood: human blood, human blood components and products made from human blood.

Bloodborne Pathogen: pathogenic microorganisms that are present in human blood and can cause disease in humans. These pathogens include, but are not limited to, Hepatitis B Virus

(HBV), Human Immunodeficiency Virus (HIV) and Hepatitis C Virus (HCV).

Bonding: Electrical bonding is the practice of intentionally electrically connecting all exposed items in a work zone together as protection from electric shock. With no difference in potential, there will be no or very little current flow across a worker's body.

Bracket Grounding: bracket grounding refers to the process of installing a set of equal potential grounds on both sides of a work site. This process is used when working on broken conductors.

Breakaway Device: a device that activates trailer brakes upon separation from the vehicle.

Break Open Threshold (EBT): *SEE Energy Break Open Threshold

Bucket self-rescue device: a fall restraint system that a person can use to lower themselves from a bucket to the ground in the event the lift becomes inoperable.

Building Evacuation Plan: a formal document containing the procedures to follow in case of a building evacuation.

Bulk Electric System (BES): All Transmission Elements operated at 100 kV or higher and Real Power and Reactive Power resources connected at 100 kV or higher. This does not include facilities used in the local distribution of electric energy. This is an abbreviated version of the NERC definition which has much greater detail.

Calorie: the amount of heat it takes to raise one gram of water one degree centigrade at one atmosphere of pressure. If you hold a lighter under your skin for one second, you will experience 1 calorie of heat.

Cant Dogs: a logging tool consisting of a handle with a moveable hook used for turning poles.

CDL: Commercial Driver's License.

Charged: isolated but not de energized, containing stored energy.

1. Electrical: A potential difference from earth or ground (i.e. charged with induced energy due to the close proximity to other energized apparatus).
2. Pneumatic & Hydraulic: Under a liquid or gaseous pressure different from that of the atmosphere.
3. Mechanical & Potential: Energy associated with the motion or position of an object & Energy which is stored (e.g. springs, compressors, linkages and etc.).

Check-in/check-out Procedures: the procedure for notifying dispatch before entering an area with coverage problems. Confirm with dispatch when clear of area.

Class A Vehicle: any combination of vehicles which has a gross combination weight rating or gross combination weight of 26,001 pounds or more, inclusive of a towed unit with a gross vehicle weight rating or gross vehicle weight of more than 10,000 pounds.

Class B Vehicle: any single vehicle which has a gross vehicle weight rating or gross vehicle weight of 26,001 pounds or more, or any such vehicle towing a vehicle with a gross vehicle weight rating or gross vehicle weight that does not exceed 10,000 pounds.

Cluster Bar: a bracket allowing the connection of more than one personal protective ground.

Code 99: clears a single radio channel or broadcast area. In the case of an emergency, a Code 99 is declared to clear that radio channel during the emergency. Radio silence must be observed by all parties not involved in the emergency until the Code 99 is cleared.

Code 1000: clears radio traffic system-wide. In the case of a system-wide emergency, System Operations can declare a Code 1000. Radio silence must be observed by all parties not involved in the emergency until the Code 1000 is cleared.

Conductor: a material, usually in the form of a wire, cable, or bus bar, used for carrying an electric current.

Confined Space: a space that:

1. Is more than five feet deep; **or**
2. Is large enough that an employee can enter and perform assigned work; **and**
3. Has limited or restricted means for entry or exit; **and**
4. Is not designed for continuous employee occupancy.

Cover-up: cover up includes rubber blankets, line hoses and hard cover.

Composite Utility Pole: a manufactured pole typically constructed of fiberglass or other plastic resin materials. Also known as FRP poles (Fiber Reinforced Polymer). These poles have different handling and framing requirements than wood poles.

CPR: Cardiopulmonary Resuscitation

Critical Lift: any lift that:

1. utilizes multiple cranes;
2. exceeds 85% of total capacity of the crane at lift radius;
3. is over an occupied structure or public street;
4. lifts an item of high value or long replacement time.

dB: decibel, used to measure a sound level.

De-Energized:

1. Electrical: Isolated *from the electrical source.
2. Pneumatic & Hydraulic: Isolated and not under pressure different from that of atmosphere.
3. Mechanical & Potential: Isolated and at rest, not retaining a charge.

Deionized Water: a type of purified water with mineral ion (salts) removed.

Dielectric: insulating material or a very poor conductor of electric current.

Dig Safe: a clearing house that notifies participating utility companies of planned digging activities.

Digger-Derrick: a specialized type of equipment equipped with augers to drill holes and with a hydraulic boom to lift, designed to install utility poles. A digger derrick does not fall under OSHA crane rules 1926.1400 when used for poles & materials associated with power transmission & distribution work.

DVIR: Driver Vehicle Inspection Report is a post-use CDL truck inspection.

Elastomeric: any material, such as natural or synthetic rubber, that is able to resume its original shape when a deforming force is removed (soft rubber).

Electrical Panel Boards: The electrical AC panels located at the Company's facilities and in substation control houses or any other junction box or enclosure that we own that houses one.

Electric Vehicle: a vehicle that is propelled by one or more electric motors, using electrical energy stored in rechargeable batteries or another energy storage device.

Element: Any electrical device with terminals that may be connected to other electrical devices such as a generator, transformer, circuit breaker, bus section, or transmission line. An Element may be comprised of one or more components. NERC definition

Versant Power: (the "Company")

Employee GO Team: a team of internal office based initial responders trained in first aid.

Employee-in-charge: the employee who has been designated foreman or the lead worker assigned responsibility for the specific job.

Employee Safety Team: a cross-functional team of employees, representing all areas of the company, to help identify safety issues and to help steer and direct the programs and initiatives of the Safety department.

EMS: Emergency Medical Services

Energized:

1. Electrical: Connected to a source of potential, or electrically charged so as to have a potential different from that of earth ground.
2. Pneumatic & Hydraulic: Under pressure different from that of atmosphere.
3. Mechanical & Potential: Not at rest, retaining a charge.

Energization Plan: A detailed plan for the physical and electrical installation of mobile substations. A plan should include: mobile installation description, engineering settings and phasing three-line diagram.

Energy Break Open Threshold (EBT): *the highest incident energy exposure value on a fabric where the garments do not exhibit break-open which is the formation of holes in the fabric that would allow heat or flames to pass through.

Engineering Controls: means controls (e.g., sharps disposal containers, self-sheathing needles, safer medical devices, such as sharps with engineered sharps injury protections and needleless systems) that isolate or remove the bloodborne pathogens hazard from the workplace.

Entry Permit: the written or printed document that is provided by the employer to allow and control entry into a confined space and that contains the information specified in OSHA 1910.146.

Entry Supervisor: the person responsible for authorizing entry, overseeing entry operations and terminating the entry. An entry supervisor also may serve as an attendant or as an authorized entrant. The duties of entry supervisor may be passed from one individual to another during the course of an entry operation.

Equal Potential Grounding: an electrical connection maintaining various exposed conductive parts at substantially the same voltage potential.

Excavation: a cavity formed in the ground by cutting, scooping or digging.

Exposed: capable of being inadvertently touched or approached nearer than a safe distance by a person.

Exposure Incident: a specific eye, mouth, other mucous membrane, non-intact skin, or parenteral contact with blood or other potentially infectious materials that result from the performance of an employee's duties.

Facility: *A set of electrical equipment that operates as a single Bulk Electric System Element (e.g., a line, a generator, a shunt compensator, transformer, etc. NERC definition)*

Fall Restraint: utilizing a properly worn full-body harness in conjunction with lifeline or lanyard that prevents an employee from reaching the edge of a walking/working surface and falling.

FCC: Federal Communications Commission

Fire Suppression Systems: a system used to control or extinguish a fire in a building. Suppression systems use a combination of dry chemicals and/or wet agents to suppress fires.

Fire Watch: an employee designated to watch for unplanned fire during hot work activity.

First Aid Provider: a person who is trained in the delivery of initial emergency procedures, using limited equipment to perform a primary assessment and intervention until Emergency Services, or EMS personnel arrives.

Flame Resistant (FR): the characteristic of a fabric to resist ignition and to self-extinguish if ignited

Flextrack Off Road Equipment: any tracked vehicle designed for off road transportation and use.

FMCSR: Federal Motor Carrier Safety Regulations

Forklift: includes fork trucks, motorized hand trucks and pallet jacks

Fuel Vapors: flammable vapors present in the air while transferring fuel

GPS: Global Positioning System

Grounded: connected to earth or to some conducting body that serves in place of the earth.

Grounding: Creating a bolted fault (dead short) from all phases to the system neutral or ground grid so that protective equipment senses the fault and trips. The grounding of a line is not personal protection for the worker.

Hazardous Chemical Inventory List: OSHA requires employers to maintain a list of the hazardous chemicals known to be present. The Hazardous Chemical Inventory lists the chemicals in use at that location. Any new hazardous chemicals received are to be documented in the Hazardous Chemical Inventory before use by any employee.

Hazardous Location: A location that is dangerous to enter for people that are unfamiliar or unqualified.

HBV: Hepatitis B Virus

HCV: Hepatitis C Virus

HIV: Human Immunodeficiency Virus

Hoisted Personnel Platform: a platform that is suspended from a crane or derrick by a wire rope.

Hot- Line Tools: an insulated tool fabricated of fiberglass reinforced plastic (FRP), hollow or foam filled that will withstand 100,000 volts per foot of length for five minutes. (This includes shotgun sticks, extendo sticks, tie sticks, switch sticks, cut-out sticks, etc.

Hybrid Vehicle: a vehicle with a gasoline engine and an electric motor, each of which can propel it.

Ice creepers: a device also known as ice cleats and is typically designed to be pulled over a boot or shoe to provide traction on icy or slippery surfaces.

Immediate Area: regarding confined space - close enough to the work location so that the attendant can perform all the assigned duties.

Incident Energy: the total amount of heat energy (per unit area) impressed (Incident) on a surface, a certain distance from the source. Measured in Calories/Square Centimeter. Cal/CM². Level varies inversely with the square of the distance between the employee and the source of the Arc (double distance = quarter energy).

Industrial Customer: a large commercial customer who typically generates power or manufactures materials and has a qualified person or persons who operate and/or control their electrical distribution system. This customer typically has one or more substations and associated electrical apparatus. (e.g. Pulp and paper mill, large commercial generator and etc.).

Information Mapping: a writing technique that divides and labels information in a document to facilitate comprehension, use and recall.

Isolated: physically disconnected or separated from source of dynamic energy by means of approved isolating devices.

Isolating Devices: switches, or disconnecting apparatus, with visible contacts, the position of which can be positively determined to be both visibly and mechanically open by an inspection of the contacts or disconnecting means. These switches must also be equipped with effective blocking device to prevent the inadvertent operation of the device.

Isolated Not Grounded (ING): This refers to primary electrical conductors that have been disconnected from energy source(s) via open switch, breaker, disconnect, etc. but NOT grounded. ING Safe Work Practices are detailed in SWP 5.22. Key to SWP 5.22 is understanding that any primary ungrounded conductor must be considered energized and all energized work rules apply. Additionally, any work done on ING primary conductors requires a red tag zone of protection be established.

Jack Stands: a stand whose height may be adjusted and which is used to support an automobile that has been raised by a jack.

Joint Use Poles: poles that carry both power and communication cables and/or equipment.

Jumper Cables: a pair of thick electric cables fitted with clips at either end, used for starting a vehicle by connecting its dead battery to the battery of another vehicle.

Junction Pole: any pole that has a primary line breaking off from the main line, whether single or three phase.

kV: kilovolt

LASER (acronym for Light Amplification by Stimulated Emission of Radiation): an intense, highly directional light source of invisible infrared and ultraviolet light, which can cause eye damage.

Lead: metallic lead, all inorganic lead compounds, and organic lead soaps.

LED: Light Emitting Diode

Licensed Operator: an operator that has obtained the proper licensing per law.

LifeFlight: state wide helicopter service providing scene response and critical care inter-facility transfer.

Lift Director: a person responsible for each lift or series of lifts on a jobsite. Ensures compliance with crane safety plan and appropriate lift plan.

Load Break Connections: an underground electrical connection that can be removed while energized.

Lockout Tree: a lockout device that allows for multiple locks to be attached to the device to be isolated.

Lower Level: an area or surface to which an employee can fall. Such areas or surfaces include, but are not limited to, ground levels, floors, platforms, ramps, runways, driveways, excavations, pits, tanks, water, equipment, structures, mud, etc.

MAD: Minimum Approach Distance

Material Handler: a device also known as a jib which is attached to an aerial lift and is used to hoist moderately sized materials and equipment.

Meal: Typically the food consumed during a planned or unplanned break, normally at least 30 minutes, on regular or overtime hours. See Article XXXI of the union contract for further guidance.

Mechanically Secured: a device designed to provide a positive block and mechanically prevent the operation of the device.

MEPCO: Maine Electrical Power Company

Minimum Approach Distance: the closest distance a qualified employee is permitted to approach either an energized or grounded object (the grounded object applies to live line work), as applicable for the work method being used.

Multiple Locks: each authorized employee shall affix a personal lockout or tagout device to the group lockout device, group lockbox, or comparable mechanism when he or she begins work, and shall remove those devices when he or she stops working on the machine or equipment being serviced or maintained.

Multi-Tiered Bus Work: a substation configuration that consists of at least a main bus and a transfer bus configured in such a way that the main bus is on the bottom with the transfer bus installed directly above it.

Mobile Eyewash Station: portable eyewash station that is designed for transportation between job sites.

Mobile Substation: a completely self-contained trailer mounted substation.

Motor Vehicle Incident: all incidents, however slight, involving a motorized vehicle or equipment. This includes accidents and property damage when the vehicle is in motion, parked, or set up in a work zone.

Musculoskeletal Disorders (MSD): injuries and disorders that affect the human body's movement or musculoskeletal system (i.e. muscles, tendons, ligaments, nerves, discs, blood vessels, etc.).

MUTCD: Manual on Uniform Traffic Control Devices

NESC: National Electrical Safety Code

NERC: North American Electric Reliability Corporation – formed by the electric utility industry to promote the reliability and adequacy of bulk power transmission in the electric utility systems of North America. NERC's mission states that it is to "ensure the reliability of the North American bulk power system." NERC's major responsibilities include working with all stakeholders to develop standards for power system operation, monitoring and enforcing compliance with those standards, assessing resource adequacy, and providing educational and training resources as part of an accreditation program to ensure power system operators remain qualified and proficient. NERC also investigates and analyzes the causes of significant power system disturbances in order to help prevent future events.

NFPA: National Fire Prevention Association

Non-PCB: any oil filled electrical equipment such as transformers, reclosers, regulators or oil that has been tested for PCBs and contains less than 50 ppm.

NOR: Northern Operating Region

Obstructed Rear Vision: any vehicle that does not have clear vision from the driver's position through the rear window to the rear of the vehicle. Vehicles identified as having obstructed vision to the rear include, but are not limited to: bucket trucks, digger trucks, derrick trucks, vans, box trucks, flatbed trucks, stock trucks, pickups with bed caps, and any other vehicle that the operator must use the outside mirrors as the primary vision aid for backing.

Operating Instruction: A command issued by a System Operator, or in the case of Locally Controlled equipment, the tag holder, as the controlling authority responsible for the safe, efficient, and reliable operation of equipment under their authority. A discussion of general information and of potential options or alternatives to resolve Bulk Electric System operating concerns is not a command and is not considered an Operating Instruction.

OPGW: Optical Ground Wire

OSHA: Occupational Safety and Health Administration

Outriggers: a projecting frame which extends from the vehicle as a means of stabilizing the vehicle during operation.

Parenteral: piercing mucous membranes or the skin barrier through such events as needle sticks, human bites, cuts and abrasions.

PCB: polychlorinated Biphenyls is any of a family of industrial compounds produced by chlorination of biphenyl, used as insulating materials in electrical equipment, including transformers and capacitors, and in various other industrial applications.

PCB Article or Oil: any oil filled electrical equipment such as transformers, reclosers, capacitors, regulators or oil that has been tested for PCBs and contains greater than 500 ppm.

PCB Contaminated Article or Oil: any oil filled electrical equipment such as transformers, reclosers, regulators or oil that has been tested for PCBs and contains between 50 and 500 ppm.

Personal Fall Arrest System: a system of components that, in the event of a fall, prevents the employee from striking the surface below the level from which he/she fell. A personal fall arrest system consists of a properly worn full body harness, a shock absorbing lanyard and a point of anchorage.

Personal Protective Equipment (PPE): specialized clothing or equipment worn by an employee for protection against a hazard. General work clothes (e.g., uniforms, pants, shirts or blouses) not intended to function as protection against a hazard are not considered to be personal protective equipment.

pH: the measurement of the acidity or alkalinity of a solution.

Piking: process of using a piking tool.

Pole Choker Device: a fall restraint device to prevent the worker from falling while climbing a pole.

Pole Tongs: a tool used to grab and guide poles.

Polyethylene: a polyether compound with many industrial applications (hard plastic).

Pool Vehicle: a vehicle that is not assigned to an employee or department.

Potentially Infectious Materials:

- (1) The following human body fluids: semen, vaginal secretions, cerebrospinal fluid, synovial fluid, pleural fluid, pericardial fluid, peritoneal fluid, amniotic fluid, saliva in dental procedures, any body fluid that is visibly contaminated with blood, and all body fluids in situations where it is difficult or impossible to differentiate between body fluids;
- (2) Any unfixed tissue or organ (other than intact skin) from a human (living or dead); and
- (3) HIV-containing cell or tissue cultures, organ cultures, and HIV- or HBV-containing culture medium or other solutions; and blood, organs, or other tissues from experimental animals infected with HIV or HBV.

PPM: parts per million

Progression Performance Criteria: the set of criteria used by the company to assess a worker's qualifications and abilities.

Proper Authorization (with respect to switching and tagging): is permission granted to employees, listed on the Switching & Tagging list maintained by SO, that follow the rules defined by Section 6.5.5 2a through 2f of this manual.

PTT: push-to-talk

Qualified: a person who, by possession of a recognized degree, certificate, or professional standing, or who by extensive knowledge, training and experience, successfully demonstrates the ability to solve problems relating to the subject matter, the work or the project.

Qualified Crane Technician: an entity that, due to its independence and expertise, has demonstrated that it is competent in accurately assessing the condition of cranes through a mechanical inspection.

Qualified Rigger: an employee whom the Company has designated as meeting the definition of a qualified employee (above) with regard to proper rigging of suspended loads.

Reliability Coordinator: The entity that is the highest level of authority who is responsible for the Reliable Operation of the Bulk Electric System, has the Wide Area view of the Bulk Electric System, and has the operating tools, processes and procedures, including the authority to prevent or mitigate emergency operating situations in both next-day analysis and real-time operations. NERC partial Definition, as applicable to section 6 of this manual.

RF: Radio Frequency

Risk Assessment: a documented process by which employees identify risks and hazards and determine the barriers that must be put in place in order to accomplish their work safely.

RTU: Remote Terminal Unit

Safety Data Sheet (SDS): a formal document containing important information about the characteristics and actual or potential hazards of a substance.

Safety Manual Review Sub-Team: a sub-team of the Employee Safety Team with the primary purpose of reviewing and recommending changes to the Safety Manual.

SCADA: Supervisory Control and Data Acquisition. An electronic remote control system designed to provide indication for and control of electrical and mechanical apparatus.

Self-retracting life line: a specific kind of lanyard used with a safety harness that automatically extends and retracts as the worker moves.

SF6: sulfur hexafluoride, an insulating gas used in electrical equipment

Shall: means mandatory; no deviations are allowed.

Should: means recommended.

Signal Person: an employee whom the Company has designated qualified with regard to the proper signaling to a Crane Operator hoisting suspended loads.

Single Point Grounding: refers to the process of installing one set of equal potential grounds at the immediate work site only.

Sno-cat: a large tracked vehicle designed for off road transportation and use.

SOR: Southern Operating Region

Space Tag: a tag affixed to a pole that marks the beginning of the electrical pole space.

Specified Classes of Apparatus: electrical and mechanical devices that are electrically or mechanically attached to a specific, isolated, or clearly defined function (i.e. breakers and apparatus directly associated with diesel generators).

Spotter: a person who is responsible to watch for and guide another person away from potential dangers.

Spotter Vehicle: a vehicle which follows behind the main vehicle for the purpose of observing the load and communicating any issues with the driver.

Squirt Boom Truck: a small articulating telescoping material device with a boom length of 42' or less.

Standard Railing: a vertical barrier erected along exposed edges of a floor opening, wall opening, ramp, platform, or runway to prevent falls of persons.

Static Wire: a grounded wire at the very top of the pole intended to protect lower conductors from lightning.

Suspended Personnel Platform: a platform that is fixed at the end of a crane or derrick boom.

Switching and Tagging List: the Switching and Tagging List includes the names of personnel who are authorized to be in charge of work or to assume responsibility for work on or near electrical apparatus under the tagging rules.

Switching List: the Switching List includes the name of personnel who are authorized to perform switching operations and who may place a tag for a person on the Switching and Tagging List. A person on the Switching List **may not** hold a tag in their name.

System Diagram: a one line diagram showing the configuration of the electrical system.

Tag Holder: a qualified person who is listed on the Switching and Tagging List who is authorized to hold a protective or clearance tag in his/her name for the purpose of safely completing work tasks.

Tailboard Briefing: an informal safety meeting, which is generally conducted at the job site prior to the commencement of a job or work shift. Job supervisors can draw attention to hazards, processes, equipment, tools, environment and materials to inform all workers of the risks in their surroundings.

T&D: Transmission and Distribution

Terminal Ground: master/tripping grounds located at the terminal location, this would normally be at a substation ground grid or switch ground grid. The purpose of this ground is to allow the protective devices to operate as designed and as quickly as possible. The grounding of the line is not considered personal protection for the worker.

Transition Lanyard: a secondary fall restraint device which is used when the primary device needs to be removed to pass over an obstacle while climbing a structure.

Transmission Operator: *The entity responsible for the reliability of its “local” transmission system, and that operates or directs the operations of the transmission facilities. NERC definition. Local in this case is from a NERC perspective, not a Local Control vs. System Operator Control perspective.*

Trenching: a long, deep and narrow hole cut in the ground.

Truck Tractor: a short truck with a drivers cab and no body designed for hauling a trailer or semi-trailer.

UL: Underwriters Laboratory

Universal Precautions: a method of infection control in which all human blood and certain human body fluids are treated as if it is known that they are infected with bloodborne pathogens including, but not limited to, the Human Immunodeficiency Virus (H.I.V.), the Hepatitis B Virus (H.B.V.), and the Hepatitis C Virus (H.C.V.)

Unobstructed Rear Vision: any vehicle that has clear vision from the driver's position through the rear window to the rear of the vehicle.

URD: Underground Residential Distribution

Voltage Tester: a piece of equipment used to detect the presence of voltage in a conductor.

Work Practice Controls: controls that reduce the likelihood of exposure by altering the manner in which a task is performed.

Zone of Clearance or Protection: an established work zone obtained within the switching and tagging process to ensure the required Switching and Tagging controls are in place prior to working on electrical equipment, lines, or apparatus. Zones of clearance require Yellow Tags *or Blue Tags* and Zones of protection require the use of Red tags, as applicable to the tag classification.

Section 2	Safe Work Practices for All Employees	
2.1	Safety Reporting & Notification Process	Effective Date: 1/1/2016 Revised: 2/28/21
2.1.1 Purpose	All safety incidents shall be reported so that the appropriate actions are taken and, if necessary, an investigation is conducted. The proper action helps the Company meet all regulatory requirements and aids in preventing a recurrence of the incident. This section provides information and safe work practices on the safety reporting process and includes guidelines for emergency or similar situations.	
2.1.2 Responsibilities	<ol style="list-style-type: none"> 1. The Company is responsible for ensuring that all federal and state safety reporting requirements are met. 2. The Company is responsible for addressing safety incidents, hazardous conditions and safety suggestions in a timely manner. 3. Supervisors are responsible for following-up on all open safety incidents within their area of responsibility. 4. Employees are responsible for reporting <u>all</u> safety incidents, including injuries, hazardous conditions and near misses. 5. Employees are responsible for following the safety reporting processes. 6. Employees are responsible for proactively identifying safety hazards or improvements. 7. Employees are responsible for immediately correcting hazardous conditions, if possible. 8. Employees are responsible for following emergency notification & response guidelines as detailed in this section. 9. Managers & Executives need to be familiar with reporting procedures as outlined in the Versant Power Communication & Reporting of Serious Safety Incidents – VP-SMS-PROC-9.01 & 9.02 	
2.1.3 Requirements	<ol style="list-style-type: none"> 1. Versant Power Safety Report Forms 2. Work Related Injury Management Process Flow Chart 3. Incident Investigation Flow Chart 	
2.1.4 Risk Identification	<ol style="list-style-type: none"> 1. Company financial or regulatory requirements liability. 2. Emotional situation following an incident. 3. Further aggravating an existing injury. 4. Unreported hazards causing injury to others. 5. Delayed/Improper response to emergency situations. 	
2.1.5 Safe Work Practices	<ol style="list-style-type: none"> 1. General <ol style="list-style-type: none"> a. Employees shall report all safety incidents and suggestions using the on-line safety report forms. http://intra.versantpower.com/resources/IncidentReporting/Incidents.cfm b. Current safety report forms include: <ol style="list-style-type: none"> i. Report an Injury ii. Report a Motor Vehicle Incident iii. Report a Hazardous Condition iv. Report a Near Miss v. Report a Copper Theft vi. Make a Safety Suggestion 	

- vii. Submit a Safety Tip of the Day
- viii. Request a Workstation Evaluation
- ix. Submit a Facilities Maintenance Request
- x. Submit a Vehicle Repair Request
- c. Employees are strongly encouraged to self-report unsafe acts or safety violations through the Safety Responsibility Policy.
http://grid.versantpower.com/se/Pages/maine_safety.aspx

2. Notification & Response for Emergency Situations (see also Section 4.2.5 for radio protocol)

- a. Car vs. Pole - Any car vs. pole accident resulting in a fatality requires:
 - i. System Operator/Central Dispatcher will contact the Safety on call person.
- b. Electrical Contact - Any public electrical contact within the Versant Power service territory requires:
 - i. System Operator/Central Dispatcher will contact the Safety on call person.
- c. Structure Fire- Any Structure Fire that may be originated by the Versant Power T&D power system or jeopardizes the three phase distribution or transmission system requires:
 - i. Line Worker on site to notify Divisional Line Supervisor
 - ii. Divisional Line Supervisor to make notifications as appropriate
- d. Substation Fire - Any substation fire within the Versant Power system requires:
 - i. Power System Technician (PST) to notify their PST Divisional Supervisor
 - ii. PST Divisional Supervisor to make notifications as appropriate
- e. Emergency Responder/Dispatch Center Circuit Trip Request - Any Emergency Dispatch Center request to trip a three phase circuit under SCADA control requires:
 - i. System Operator to document request & log trip
 - ii. System Operator to submit MPUC Outage Notification if a qualifying event based on #customers off. EMAIL notification is appropriate.
- f. Responding to emergency situations such as a structure fire, car-pole accident, electrical contact by a person shall require:
 - i. Line Workers on call duty who are called to respond to an Emergency Situation are to provide an Estimated Time of Arrival (ETA)
 - ii. Call Duty Supervisor required to notify the System Operator of a received ETA when providing notice of who is responding
 - iii. For incident scenes that have an incident commander, (typically police or fire) Versant Power responders should report to the incident commander prior to beginning work. If this is not practical or possible, the Versant Power responders shall contact the incident commander as soon as possible without compromising scene safety.
- g. Notification of Emergency Services for serious injuries including electrical contact, loss of consciousness, or altered mental status – see First Aid (Section 11) for further guidance:

- i. Call 911 immediately and get Emergency Medical Services on site. ***Use a cell phone whenever possible as EMS has cell phone tracking capabilities to help direct resources to the site.*** Do not transport a seriously injured person as described above unless you have no other option. The 911 system can provide better site location to EMS than Versant Power's Avail system so 911 needs to be the first call if EMS is needed. The emergency calling features of our vehicles will respond to 911 voice calling commands.
- ii. Administer first aid per Section 11 of this manual while waiting on arrival of EMS.

3. Initiating a Work Stoppage

- a. When a serious injury or incident occurs, a work stoppage shall occur once the scene is made safe.
 - i. Once a stoppage is in place, a review of the incident will occur to determine if and when it is safe to continue work.
 - ii. A return to work order can occur if both the Safety Department and the Department Supervisor agree it is safe to continue

4. Injury Reporting

- a. All employees shall follow the Work Related Injury Management Process, Attachment A.
- b. Employees shall immediately report all work place injuries, however slight, to their supervisor or the Safety Department. The employee must confirm supervisor or safety is aware of the injury report.
- c. Employee or supervisor shall complete and submit the Injury Report Form for work place injuries as soon as possible.
- d. Employees are encouraged to report to their supervisor injuries that occur outside the workplace that could potentially impact their ability to perform their daily work tasks.

5. Motor Vehicle Incidents

- a. Incidents involving high or medium potential reporting:
 - Immediately dial 911 if emergency services are needed.
 - Notify supervisor and/or Safety Department as soon as possible.
 - Employee and all passengers shall not leave the scene of the incident.
 - Employee and all passengers shall provide their name only and the Company's name and address to all parties involved in the incident.
 - Employee shall obtain names and addresses of all others involved in the incident including all available witnesses, unless obtained by the investigating officer.
 - Employee and all passengers shall avoid confrontation and shall not give statements to anyone other than a company representative or investigating officer(s).
 - The employee shall complete and submit a Motor Vehicle Incident Report as soon as possible.
- b. Incidents involving low potential reporting:
 - Notify supervisor and/or Safety Department.
 - Report minor property damage to Central Dispatch for follow-up.
 - Avoid making statements regarding Company's liability.

	<ul style="list-style-type: none"> ➤ Ensure vehicle is operable before use. ➤ Fill out a Motor Vehicle Incident Report. <p>6. Pro-Active Safety Reporting</p> <ul style="list-style-type: none"> a. Employees should be aware of their surroundings and actively look for and identify <u>Hazardous Conditions</u>. Hazardous Conditions shall be reported to eliminate or minimize work place hazards. b. Employees shall report all <u>Near Miss</u> incidents. Near Miss incidents are unplanned events that did not result in injury, illness or damage, but had the potential to do so. c. Theft of services and property (e.g. <u>Copper Theft</u>) are extremely dangerous, not only for the person perpetrating the crime but for our employees and the public. Employees shall report observations of such incidents. d. Employees are encouraged to submit <u>Safety Suggestions</u> when they feel there is an opportunity for improvement to a process, procedure or the Safety Manual. e. Employees are encouraged to submit a <u>Safety Tip of the Day</u> to be shared with all employees to raise awareness of general safety topics. f. Employees shall request a <u>Workstation Evaluation</u> when setting up a new workstation or if they are experiencing difficulty with an existing work station. <p>7. Incident Investigation</p> <ul style="list-style-type: none"> a. Incidents classified as High Potential shall undergo the root cause analysis process. b. Refer to the Safety Department for more information on this process.
<p>2.1.6 Definitions</p>	<p>Motor Vehicle Incident: all incidents, however slight, involving a motorized vehicle or equipment. This includes accidents and property damage when the vehicle is in motion, parked, or set up in a work zone.</p>

Work Related Injury Management Process

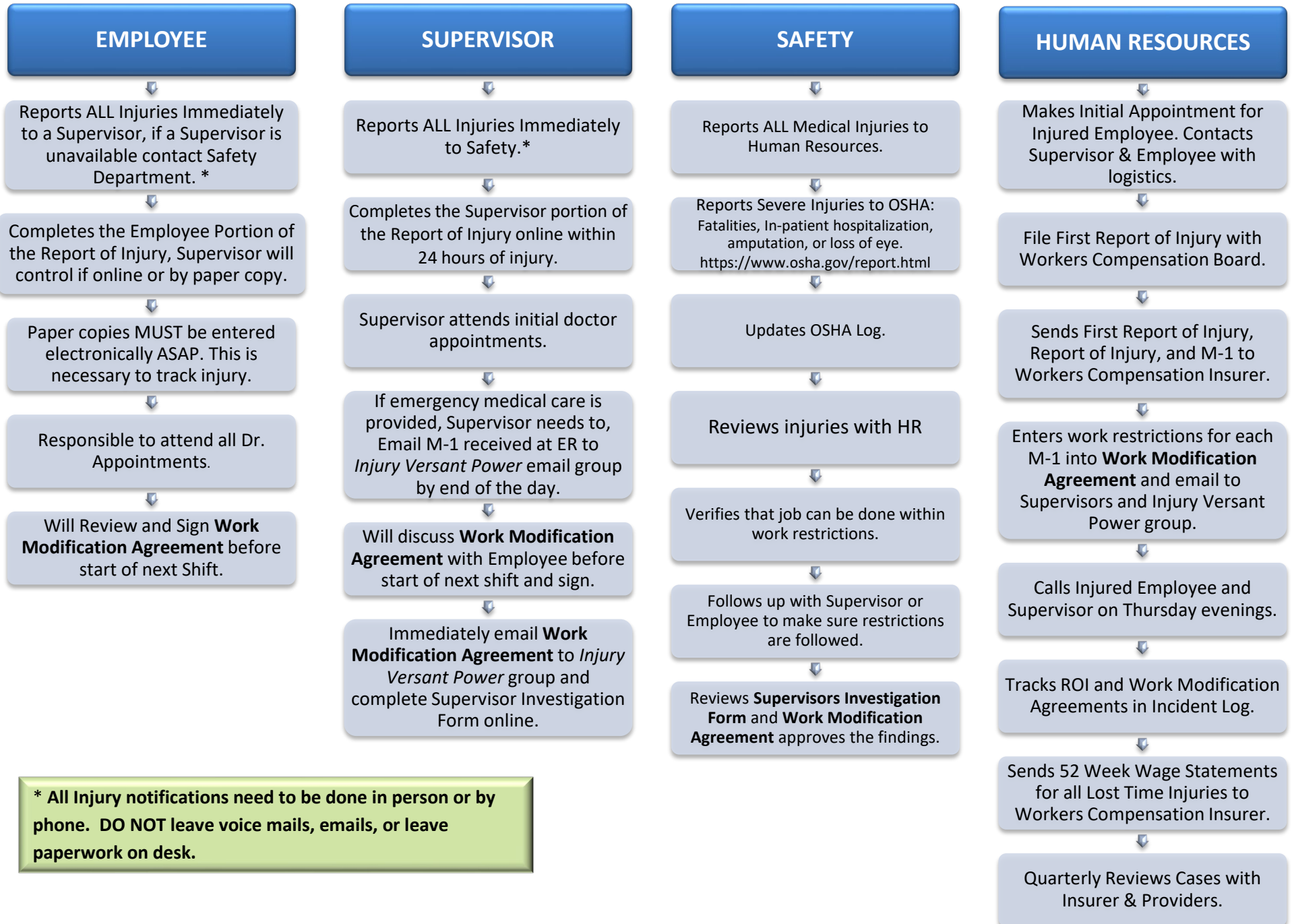

* All Injury notifications need to be done in person or by phone. DO NOT leave voice mails, emails, or leave paperwork on desk.

CONTACTS – You can e-mail the entire group at Injury@versantpower.com

Safety Contacts:	Office Phone	Cell Phone	E-Mail Address
Stan Hartin	(207) 760-2540	(207) 227-2197	stan.hartin@versantpower.com
Brian Gould	(207) 973-2656	(207) 227-8010	brian.gould@versantpower.com
Joe Thibodeau	(207) 760-2547	(207) 227-1802	joseph.thibodeau@versantpower.com
Joe Eremita	(207) 973-2802	(207) 949-1181	joseph.eremita@versantpower.com
Mark Deschesne	(207) 973-2755	(207) 949-0795	mark.deschesne@versantpower.com
Jeff Williams	(207) 973 2903	(207) 944 4531	jeffery.williams@versantpower.com
Ryan Rudolph	(207) 973-2823	(207) 949-5363	ryan.rudolph@versantpower.com
HR Contacts:	Office Phone	Cell Phone	E-Mail Address
Tammy Colbert	(207) 973-2692	(207) 944-2867	tammy.colbert@versantpower.com

FAQ – Frequently Asked Questions

Q: Supervisor – What do I do if an employee calls in sick due to his injury?

A: Contact HR. HR will make an appointment for the employee. The absence is sick time unless we have an M-1 taking an employee out of work.

Q: What code do we use on the Time Card?

A: When an employee goes to a work related medical appointment or is taken out of work use the Code A.

Q: Supervisor - What do I do if I don't have work available that meets the Work Restrictions?

A: Contact HR and we will assist in coordinating work assignments.

Contact HR with any Injury Management Questions

Section 2	Safe Work Practices for All Employees	
2.2	Tailboard Briefing and Risk Assessment	Effective Date: 1/1/2016 Revised: 3/1/2019
2.2.1 Purpose	The purpose of carrying out tailboard briefings and Risk Assessments is to promote open communication between all crew members and help identify and mitigate hazards that may be encountered. This section provides information and safe work practices for conducting tailboard briefings and Risk Assessments.	
2.2.2 Responsibilities	<ol style="list-style-type: none"> 1. The Company is responsible for setting the content and completion expectations for tailboard briefings and Risk Assessments. 2. The employee in-charge is responsible for making sure the tailboard briefing and Risk Assessments are completed, prior to beginning work. 3. All employees are responsible for participating in and understanding the tailboard briefing and Risk Assessment for the work being conducted. 	
2.2.3 Requirements	<ol style="list-style-type: none"> 1. Tailboard Briefing 2. Risk Assessment Form 	
2.2.4 Risk Identification	<ol style="list-style-type: none"> 1. Failure to recognize the hazards 2. Failure to place the proper barriers 3. Lack of job coordination 	
2.2.5 Safe Work Practices	<ol style="list-style-type: none"> 1. Tailboard Briefing <ol style="list-style-type: none"> a. When more than one crew member, including contractors, is involved in a job a tailboard briefing shall be conducted prior to beginning work on a daily basis at minimum b. The tailboard briefing should be conducted at the job site. c. The tailboard briefing shall contain the following steps: <ol style="list-style-type: none"> i. <u>Talk</u> about the job. All crew members shall openly discuss the work to be done, the hazards involved, and the barriers to be used. ii. <u>Assign</u> employees specific duties. The employee in-charge shall assign the work based on employee qualifications and skills. Refer to Section 5.1 Roles and Responsibilities of T&D Workers. iii. <u>Identify</u> known hazards and the barriers to reduce or eliminate the hazards. When conditions change, work shall stop and the crew members shall re-group to identify new hazards and barriers. iv. <u>Let</u> employees know what is expected. The employee in-charge shall set and communicate the safety expectations. v. <u>Beware</u> of unforeseen hazards. All crew members shall be 	

on the alert for unforeseen hazards and shall notify the employee in-charge or crew members of any potential hazard.

- vi. Observe applicable safe work practices. If an employee is unfamiliar or uncertain of the safe work practices for the specific job they shall review the Safety Manual or ask the employee in-charge.
 - vii. Allow time to do the job safely. No job is so important that employees cannot take the time to do it safely.
 - viii. Review protective equipment. Refer to **Section 2.8 Personal Protective Equipment**.
 - ix. Determine if employees understand their duties. The employee in-charge shall ensure all crew members understand their duties. Each crew member shall understand the following:
 - known hazards
 - barriers to be used
 - personal and work area protection
 - their role in the overall job
- d. If required, the tailboard briefing shall include a review of the Risk Assessment with everyone that will be on the job.

2. Risk Assessment

- a. All crew members present, including contractors, shall sign the Risk Assessment.
http://grid.versantpower.com/se/Pages/maine_safety.aspx
- b. Different departments may choose to use different risk assessment forms with the intent that the form be in alignment with the type of work being performed. Any form being used by Versant Power employees must be approved by the Versant Power Safety Dept.
- c. If additional employees arrive on the job site at a later time, they shall be immediately briefed on the content of the Risk Assessment.
- d. When the same tasks are to be repeated multiple times during the day, one Risk Assessment may be completed.
- e. The Risk Assessment shall identify the hazards, barriers and work locations.
- f. A Risk Assessment shall be completed anytime there is a question if one is required.
- g. A Risk Assessment shall be considered anytime there is a change to the work plan or working conditions.
- h. Tasks, or tasks of similar nature, requiring a Risk Assessment are:
 - secondary connections, side of house, out of a bucket
 - secondary connections, side of house, off a ladder
 - loading anything with a digger-derrick, boom or crane truck

- setting a pole
- building a line extension
- retying a loose conductor
- responding to a house fire and only after life threatening issues are resolved
- conducting a three-phase transfer
- setting a meter
- hanging a transformer roadside
- padmount inspections
- operating a chainsaw
- forklift loading or unloading
- working on a ladder over 4 ft
- infrared scanning
- battery maintenance
- breaker maintenance
- power factor testing
- substation construction
- Bangor & Loring underground
- testing or construction of Underground Residential Distribution (URD)
- SCADA troubleshooting
- diesel work
- shop work
- small generator maintenance
- primary or secondary rated meter testing
- AMR inspections
- motor operator inspections
- relay maintenance
- substation alarm troubleshooting
- nitrogen change-out
- substation tours
- climbing a pole for training purpose
- street light bulb replacement
- switching or physically operating any device
- loading wire onto a trailer or truck
- pruning trees on a service with a manual saw
- loading and unloading large track equipment
- when entering a right of way on foot or by vehicle

i. Tasks, or tasks of similar nature, that do not require a Risk Assessment are:

- stocking truck cabinets with items
- washing truck
- cleaning boom
- completing a Driver Vehicle Inspection Report (DVIR)
- completing an Employee Development System (EDS) course

	<ul style="list-style-type: none"> ➤ patrolling roadside but no problems found ➤ loading tools or supplies at shop ➤ driving ➤ office work ➤ line recloser reads ➤ staff meetings (in meeting rooms) ➤ SPCC Inspections (outside of sub-station) ➤ snow plowing (outside of sub-station) ➤ sharpening a chain saw ➤ print work ➤ loading a snow mobile or ATV on a trailer ➤ resetting a transformer from the ground ➤ placing or checking a yellow tag on an open switch ➤ substation walk-through ➤ operating a bucket from lower controls ➤ driving trucks onto a barge
<p>2.2.6 Definitions</p>	<p>Risk Assessment: a documented process by which employees identify risks and hazards and determine the barriers that must be put in place in order to accomplish their work safely.</p> <p>Tailboard Briefing: an informal safety meeting, which is generally conducted at the job site prior to the commencement of a job or work shift. Job supervisors can draw attention to hazards, processes, equipment, tools, environment and materials to inform all workers of the risks in their surroundings.</p>

Section 2	Safe Work Practices for All Employees	
2.3	Employees Overseeing Work	Effective Date: 1/1/2016 Revised: 1/1/2017
2.3.1 Purpose	Employees at all levels of the Company can oversee work, whether as a manager or supervisor, or temporarily as a project manager or lead. This section provides safe work practices for employees performing oversight of work.	
2.3.2 Responsibilities	<ol style="list-style-type: none"> 1. Executives and managers shall be responsible for promoting the safety principles of the Company. 2. The supervisor is responsible for general worker safety and safe work conditions within their area of responsibility. 3. The employee in-charge is responsible for the safe condition of the work area and the use of safe work practices by personnel under their direction. 4. Employees are responsible for compliance with all safe work practices for work under their direction. 	
2.3.3 Requirements	<ol style="list-style-type: none"> 1. Tailboard Briefing 2. Risk Assessment 3. Work Performance Monitoring 	
2.3.4 Risk Identification	<ol style="list-style-type: none"> 1. Employees not following the safe work practices. 2. Unsafe work site conditions. 3. Inadequate oversight of employees resulting in a relaxation of safe work practices. 	
2.3.5 Safe Work Practices	<ol style="list-style-type: none"> 1. Executives and managers shall provide the appropriate level of oversight and necessary resources to ensure the safety of all employees. 2. Supervisors shall ensure the following within their area of responsibility: <ol style="list-style-type: none"> a. Have a thorough knowledge of, observe and enforce all safe work practices within their area of responsibility. b. Immediate steps are taken to correct any violation of safe work practices, whether observed or reported. c. Safety manuals and training are provided to employees. d. Employees are made knowledgeable of the proper use of all devices, equipment and clothing required for their protection. e. Tools and equipment are available and are properly maintained. f. Qualified employees are appropriately assigned to perform the job safely. g. A sufficient number of employees are assigned to perform the job safely. h. Risk Assessments, when required, are completed, reviewed and 	

	<p>understood.</p> <ul style="list-style-type: none"> i. Safety meetings are being conducted and documented as required. <p>3. Employees-in-Charge are responsible to ensure the following:</p> <ul style="list-style-type: none"> a. Have a thorough knowledge of, observe and enforce all safe work practices within their area of responsibility. b. Before commencing field work, the employee-in-charge shall ensure that a tailboard briefing is conducted addressing that: <ul style="list-style-type: none"> i. a Risk Assessment is completed, if necessary ii. workers are informed of the work to be done and their role iii. hazards have been mitigated c. The employee-in-charge shall monitor the job and stop the job if any unsafe conditions occur. <p>4. Employees are responsible to ensure the following:</p> <ul style="list-style-type: none"> a. Have a thorough knowledge of and observe all safe work practices within their work function. b. Employees have the responsibility and the authority to stop any job (company or private) if they observe unsafe work practices on or around the Company's T&D system. c. When contractors are working for the Company, employees shall stop the work if they observe unsafe work practices. d. A qualified employee shall accompany all site visitors while on or around Company hazardous locations.
<p>2.3.6 Definitions</p>	<p>Employee in-charge: the employee who has been designated foreman or the lead worker assigned responsibility for the specific job.</p> <p>Hazardous Location: A location that is dangerous to enter for people that are unfamiliar or unqualified.</p>

Section 2	Safe Work Practices for All Employees	
2.4	General	Effective Date: 1/1/2016 Revised: 1/1/2018
2.4.1 Purpose	The purpose of this section is to provide basic information and safe work practices on general topics that are applicable to all employees.	
2.4.2 Responsibilities	<ol style="list-style-type: none"> 1. The Company is responsible for determining safety meeting intervals for each department. 2. Supervisors are responsible for adequately communicating safety information to employees. 3. Employees are responsible for following the safe work practices as set forth in this section. 	
2.4.3 Requirements	<ol style="list-style-type: none"> 1. Appropriate Clothing 2. PPE 3. Warning Signs 4. Floor Guards and Barricades 	
2.4.4 Risk Identification	<ol style="list-style-type: none"> 1. Workplace safety information not adequately communicated to employees. 2. Personal injury or death for failure to observe safe work practices. 3. Public safety around the work zone. 	
2.4.5 Safe Work Practices	<ol style="list-style-type: none"> 1. Safety Meetings <ol style="list-style-type: none"> a. Safety meetings shall be for the purpose of distributing, discussing and raising awareness of safety related information. b. Each employee shall attend all departmental safety meetings unless on special duty or specifically excused by their supervisor. c. The supervisor shall ensure the contents of the meeting are reviewed with any absent employee. 2. Clothing and Footwear <ol style="list-style-type: none"> a. All employees working in or visiting field locations are required to wear the proper PPE. Refer to Section 2.8 Personal Protective Equipment. b. Employees shall <u>not</u> wear jewelry of any kind while working on electrical equipment of any voltage (energized or de-energized). Exceptions to this safe work practice are as follows: <ol style="list-style-type: none"> i. Electrically or thermally nonconductive jewelry shall be approved on a case by case basis by the Safety Department. ii. Company approved medical bracelets. c. While working on rotating machinery or equipment such as paper shredders or electric motors, employees shall ensure that all loose clothing or jewelry are out of the line of fire and proper PPE 	

is worn.

- d. Clothing suitable for work conditions shall be worn at all times.
- e. Refer to the Company's appearance policy for more information.
http://grid.versantpower.com/pp/Pages/hr_policies.aspx
- f. Footwear appropriate for work conditions shall be worn at all times.
- g. Per 2.8.5 7a and b - Employees shall wear traction aids (creepers) when conditions warrant.

3. Approaching Unfamiliar Job Sites

- a. When an employee enters a job site where hazards may exist, they shall immediately make their presence known to the employee in-charge and the employee-in-charge shall conduct a tailboard briefing or review the Risk Assessment with that employee.
- b. When an employee is in an unfamiliar job site they shall be accompanied by a qualified employee.
- c. Refer to **Section 5.11 Substations** for information on entering substations.

4. Speaking to Workers

- a. Care should be exercised in speaking to workers who are working on or near energized conductors, switches, or other apparatus of any voltage, unless the person spoken to is aware of your presence.
- b. Never startle a worker.

5. Repositioning during work or observing work

- a. During process of completing work, employees need to be aware of hazards around them including their own movements, keeping their eyes and mind on task.
- b. If moving while working/observing is necessary, inspect your travel route in advance and address any hazards.

6. Guarding of Floor Openings

- a. Floor openings shall be guarded by a standard railing and toe boards or cover.
- b. A railing shall be provided on all exposed sides of the floor opening.
- c. Temporary floor openings shall be barricaded.
- d. Entrances to ladder ways or floor openings shall be guarded by a swinging gate or offset so that a person cannot walk directly into the opening.
- e. The edge of every open-sided floor or platform four feet or more above the next lower surface or ground level shall be guarded by a standard railing.

	<p>7. Warnings and Signs</p> <ul style="list-style-type: none"> a. Hazardous work areas shall be appropriately signed. b. Warning signs shall be heeded. c. Only authorized workers shall be allowed to enter a hazardous work area. d. Warnings shall be given to others when they are observed in dangerous situations. <p>8. Protecting the Public</p> <ul style="list-style-type: none"> a. Keep pedestrians and vehicles away from hazardous work locations. b. Work zones shall be properly marked and barricaded. Refer to <i>Section 3.4 Operating in Traffic.</i> c. All materials shall be removed from the job site when the work is completed. <p>9. Irresponsible Actions</p> <ul style="list-style-type: none"> a. Employees shall not engage in scuffling, horseplay, pranks or jokes which could harm another person. b. Employees shall not take chances or safety short cuts and shall not urge or permit others to do so.
<p>2.4.6 Definitions</p>	<p>Standard Railing: a vertical barrier erected along exposed edges of a floor opening, wall opening, ramp, platform, or runway to prevent falls of persons.</p>

Section 2	Safe Work Practices for All Employees	
2.5	Housekeeping and Fire Prevention	Effective Date: 1/1/2016 Revised: 1/1/2017
2.5.1 Purpose	A clean and orderly work space promotes a safe working environment and reduces the risk of fire hazards. The purpose of this section to provide information and safe work practices for housekeeping and fire prevention.	
2.5.2 Responsibilities	<ol style="list-style-type: none"> 1. The Company is responsible for complying with all NFPA and state and local regulations and ordinances. 2. Supervisors are responsible for housekeeping and fire prevention within their area of responsibility. 3. Employees are responsible for exhibiting good housekeeping within their area of responsibility. 	
2.5.3 Requirements	<ol style="list-style-type: none"> 1. Fire Extinguishers 2. Building Evacuation Plan 3. Approved storage containers for flammable materials 4. Housekeeping Inspections 	
2.5.4 Risk Identification	<ol style="list-style-type: none"> 1. Inadequate facilities maintenance or insufficient evacuation plans resulting in Company liability. 2. Personal injury or death. 3. Property damage or losses. 	
2.5.5 Safe Work Practices	<ol style="list-style-type: none"> 1. General <ol style="list-style-type: none"> a. All company facilities and work locations, whether temporary or permanent, shall be kept neat and orderly. b. Facilities maintenance items in need of attention shall be reported using the Facilities Maintenance Request Form. http://intra.versantpower.com/resources/forms/form_facility.cfm c. Emergency equipment shall be kept clear of obstructions. Examples of emergency equipment include: <ol style="list-style-type: none"> i. fire alarms ii. fire extinguishers iii. first-aid equipment iv. electrical panels v. eye wash stations d. The building evacuation plan shall be posted at each facility in the appropriate locations. e. All employees shall be trained on the building evacuation plan. f. The building evacuation plan shall be communicated to visitors as necessary. g. A fire drill should be conducted at each location a minimum of once per year. h. A distance of at least 18 inches shall be maintained between piles 	

of material and automatic sprinkler heads.

- i. A minimum distance of 36 inches shall be maintained in front of electrical panels.
- j. Steps and walkways shall be kept clear of ice, snow and debris and properly sanded whenever possible.
- k. Ice and snow on roofs shall not be allowed to accumulate over walkways and doorways.
- l. Aisles and exits shall be kept free of obstructions.
- m. Exits shall be properly marked.
- n. Boxes, crates and other packing supplies shall be properly stored to avoid falling or tripping hazards.
- o. All used rags that are contaminated with flammable oil, solvents, liquids or debris shall be disposed of in UL approved covered metal containers.
- p. Gasoline and other flammable liquids shall be kept in UL approved containers, which shall be stored in approved lockers.
- q. Liquids such as gasoline, naphtha or kerosene shall not be used as a cleaning solvent.
- r. Areas surrounding fuel oil storage tanks shall be kept clear of combustible materials.

2. Housekeeping Inspections

- a. Annual housekeeping audits shall be conducted by the Employee Safety Team.
- b. The Safety Department shall report all housekeeping deficiencies to the Facilities Department for remediation.
- c. Informal housekeeping observations should be performed by all employees on an on-going basis.
- d. Third-party housekeeping audits shall be conducted annually.

3. Fire Extinguishers

- a. Fire extinguishers shall be maintained in a fully charged and operable condition and kept in a designated place.
- b. Employees shall be familiar with the location and operation of the fire extinguishing equipment in the vicinity of their work location.
- c. All extinguishers shall be marked with their applicable rating (Class A, B, C, D).
- d. Employees shall receive annual fire extinguisher training.
- e. Fire extinguishers shall be inspected on a monthly basis.
- f. The fire extinguisher inspection tag shall be updated monthly with the date of inspection.
- g. Fire extinguishers shall be annually inspected by a qualified third-party and, if necessary, replaced or refurbished.

4. Fire Suppression Systems

- a. Employees should be familiar with the location and operation of the fire suppression system in the vicinity of their work location.
- b. Employees shall be familiar with the location and operation of the

	<p>pull stations associated with the fire suppression system.</p> <p>c. Fire suppression systems shall be inspected on a monthly basis.</p> <p>d. Fire suppression systems shall be bi-annually inspected by a qualified third-party.</p>
<p>2.5.6 Definitions</p>	<p>Building Evacuation Plan: a formal document containing the procedures to follow in case of a building evacuation.</p> <p>Fire Suppression Systems: a system used to control or extinguish a fire in a building. Suppression systems use a combination of dry chemicals and/or wet agents to suppress fires.</p> <p>NFPA: National Fire Prevention Association</p> <p>UL: Underwriters Laboratory</p>

Section 2	Safe Work Practices for All Employees	
2.6	In the Office	Effective Date: 1/1/2016 Revised:3/1/2019
2.6.1 Purpose	Slipping, tripping, cutting and distracted employees are common causes of office accidents and injuries. The purpose of this section is to provide safe work practices regarding the office environment and activities.	
2.6.2 Responsibilities	<ol style="list-style-type: none"> 1. The Company is responsible for providing a safe office environment. 2. The Company is responsible for providing safe office furniture and equipment. 3. The employee is responsible for using office equipment safely. 	
2.6.3 Requirements	<ol style="list-style-type: none"> 1. Safe and appropriate office equipment 2. Proper training, as applicable 	
2.6.4 Risk Identification	<ol style="list-style-type: none"> 1. Falling objects or tripping hazards resulting in personal injury. 2. Suspicious or hostile persons around or entering the work place. 3. Fire Hazards. 	
2.6.5 Safe Work Practices	<ol style="list-style-type: none"> 1. Filing Cabinets and Desks <ol style="list-style-type: none"> a. All desk and cabinet drawers shall be closed when not in use. b. Only one drawer shall be open at any one time. c. Place the heaviest loads in lower drawers or shelves to avoid top loading. d. Heavier objects that present a falling hazard should not be stored on top of cabinets or other storage enclosures. e. Always use handles when closing drawers. 2. Chairs <ol style="list-style-type: none"> a. Use office chairs appropriately to avoid tipping. b. Do not stand, lean or sit on the edge of chairs. c. Ensure the area is clear and there is adequate space before swinging around or pushing a chair away from the desk. d. Chairs should be inspected on a regular basis to make sure all the parts or components are appropriately tightened. e. Defective chairs shall not be used and shall be reported to the supervisor or Facilities Department. 3. Office Supplies and Equipment <ol style="list-style-type: none"> a. Sharp or pointed objects such as pencils, knives, scissors or envelope openers shall be safely stored. b. Paper cutter blades shall be down and secured when not in use. c. When in use, ensure hands and fingers are clear of staplers, paper punches, paper cutters or other devices. 	

- d. Electrically powered office equipment shall be operated in accordance with the manufacturer's instructions.
- e. Only Company supplied portable space heaters shall be used.
- f. Portable space heaters shall be attended while in use.
- g. Portable space heaters shall be operated according to manufacturer's instructions.
- h. Employees shall be familiar with the operation of Company supplied exercise equipment prior to use.

4. Electrical Cords

- a. Only three-pronged three-wire extension cords shall be used.
- b. Extension cords should be regularly inspected and shall be discarded if damaged, frayed or worn.
- c. Do not exceed receptacle ratings.
- d. When using power strips, follow the manufacturer's recommendations.
- e. Power strips shall not be connected in series.

5. Movement in the Office

- a. Avoid distractions, such as using cellphones, reading materials and etc. when moving through office areas.
- b. Always keep to the right of passageways, especially when approaching or turning corners.
- c. Approach and open all doors with caution.
- d. Avoid standing in the path of a door.
- e. Employees shall not run in the office or up and down stairs.
- f. Handrails should be used when walking up or down stairs.
- g. If handrails or stair treads appear defective, submit a maintenance request by completing a Facilities Maintenance Request Form.

http://intra.versantpower.com/resources/forms/form_facility.cfm

6. Aisles and Hallways

- a. Aisles and hallways shall be kept clear of obstructions, such as chairs, wastebaskets, boxes, and other objects.
- b. Cords such as communication cords, power cords and etc. shall not be placed in aisles or hallways. If this cannot be avoided, they shall be appropriately secured and/or marked.

7. Kitchen Areas

- a. Use kitchen appliances in accordance with the manufacturer's instructions.
- b. Cooking appliances shall be attended at all times when in use.
- c. Ensure ovens and burners are turned off after use.
- d. Coffee pots shall be turned off when not in use.
- e. All sharp utensils shall be placed in dishwashers with the sharp end down.
- f. Cupboard doors shall be kept closed at all times when not

	<p>retrieving or placing items.</p> <ul style="list-style-type: none"> g. Employees shall wipe up all spills immediately. h. Community refrigerators and microwaves shall be cleaned on a regular basis. <p>8. Security</p> <ul style="list-style-type: none"> a. Unfamiliar or unauthorized persons shall not be permitted into company facilities. b. Notify the Security Department of suspicious or hostile persons loitering near or on company facilities. c. The Company shall promptly notify employees of staffing changes. d. Employees entering or exiting facilities after dark should be aware of their surroundings and take extra precautions as necessary. e. Windows should only be open during regular business hours. f. Employees shall be responsible for their own visitors while in company facilities. This may include signing-in/signing out guests and ensuring visitor badges are worn and turned in. g. Contractors visiting Versant Power facilities shall attempt to notify a Versant Power employee upon arrival. <p>9. Facility Maintenance</p> <ul style="list-style-type: none"> a. Known hazards shall be promptly reported using the Facilities Maintenance Request Form. b. Employees shall be notified of any facility hazard and the necessary precautions taken to mitigate the issue until permanent repairs can be made. c. Caution signs shall be placed when floors are wet or when other slippery conditions exist. d. Outside walkways shall be kept clear of snow and salted when necessary. e. Differences in floor elevation in aisles, platforms and doorways shall be clearly marked.
<p>2.6.6 Definitions</p>	

Section 2	Safe Work Practices For All Employees	
2.7	Ergonomics	Effective Date: 1/1/2016 Revised: 9/15/2020
2.7.1 Purpose	The purpose of this section is to provide information and safe work practices to aid in reducing or eliminating work-related musculoskeletal disorders (“MSD”).	
2.7.2 Responsibilities	<ol style="list-style-type: none"> 1. The Company is responsible for providing workstation evaluations upon request. 2. The Company is responsible for providing video display training to all applicable employees. 3. The employee is responsible for practicing correct workstation posture and positioning. 4. The employee is responsible for taking appropriate stretch breaks. 5. The employee is responsible for recognizing and reporting workstation deficiencies. 6. The employee is responsible for reporting signs of MSD. 	
2.7.3 Requirements	<ol style="list-style-type: none"> 1. Video Display Terminal Training 2. Work Station Assessments 	
2.7.4 Risk Identification	<ol style="list-style-type: none"> 1. Improper ergonomics resulting in soft tissue injuries, worker fatigue and neck and back strains. 	
2.7.5 Safe Work Practices	<ol style="list-style-type: none"> 1. Avoiding Musculoskeletal disorders <ol style="list-style-type: none"> a. Employees should be aware of the behaviors that can lead to the development of MSD: <ol style="list-style-type: none"> i. awkward postures ii. excessive force iii. excessive repetition iv. contact stress (hard edge/pressure) v. heavy vibration (increased risk at cold temperatures) b. Employees should recognize the signs of MSD: <ol style="list-style-type: none"> i. discomfort, pain, dull ache ii. decreased range of motion iii. deformity or swelling iv. decreased grip strength v. loss of function (e.g. cannot close hand) vi. persistent numbness vii. burning and tingling sensation viii. cramping ix. stiffness c. The following can help prevent MSD: <ol style="list-style-type: none"> i. Well-designed work spaces including seating, foot rest and 	

- monitor stands.
- ii. Alternating work patterns and tasks as much as possible throughout the day to allow rest for different muscle groups.
- iii. Performing stretching exercises periodically throughout the workday to relieve stressed muscles.
- iv. Keeping the body in neutral positions as much as possible.
- v. Always using good posture.
- d. Employees shall report signs of MSD through the incident reporting process. Refer to **Section 2.1 Safety Reporting**.
- e. Work Station ergonomic assessments can be requested on the grid at [http://intra.versantpower.com//employee_corner/WorkStation Eval.cfm](http://intra.versantpower.com//employee_corner/WorkStation_Eval.cfm)

2. Workstations

- a. When working at a computer workstation, employees should consider the following:
 - i. Adjust the working height of chair, desk, standing work station and keyboard.
 - ii. Adjust the monitor and copy stand side-by-side to be at a comfortable viewing angle.
 - iii. Sit in an upright position using good posture.
 - iv. Set angle of the monitor to reduce glare or use a glare resistant screen.
 - v. Keep wrists and hands in line while using keyboard and mouse. Avoid bending wrists forward or backward.
 - vi. To prevent eye fatigue, regularly focus eyes on a distant object.
 - vii. Take frequent stretch breaks to prevent buildup of muscle tension.
 - viii. Use footrests as necessary.
 - ix. For prolonged or continuous telephone use, headsets or speakerphone shall be used.
 - x. Organize work areas to avoid stretching or twisting to reach items.

3. Stretching

- a. Stretch breaks should be conducted at least twice a day.
- b. Stretch breaks should be a minimum of 5 minutes.
- c. Perform one to two stretching exercises between work tasks or when getting up from a prolonged static posture.

4. Manual Transport

- a. When employees are moving or lifting materials or objects they shall:
 - i. maintain correct posture
 - ii. request assistance, if necessary
 - iii. use lifting aids, if required
- b. Lifting and moving techniques:
 - i. Use mechanical equipment, if available

	<ul style="list-style-type: none"> ii. Lifting <ul style="list-style-type: none"> ➤ keep the load close to your body ➤ bend your knees and hips ➤ lift with your legs ➤ avoid twisting as you lift iii. Bending <ul style="list-style-type: none"> ➤ kneel on one knee ➤ bend knees and hips, not your back ➤ when leaning forward, move your whole body, not just your arms iv. Repetitive motions <ul style="list-style-type: none"> ➤ keep the load small ➤ turn your whole body instead of twisting ➤ get close to the load; do not reach and lift ➤ lift with your arms and legs, not your back ➤ change positions frequently v. Reaching <ul style="list-style-type: none"> ➤ do not overextend your reach ➤ if you need to reach above a safe level, use a ladder or step stool ➤ test the weight of the load before lifting; let your arms and legs do the work, not your back vi. Pushing and pulling <ul style="list-style-type: none"> ➤ stay close to the load; do not lean forward ➤ push the load rather than pull the load ➤ use both hands
<p>2.7.6 Definitions</p>	<p>Musculoskeletal Disorders (MSD): injuries and disorders that affect the human body’s movement or musculoskeletal system (i.e. muscles, tendons, ligaments, nerves, discs, blood vessels, etc.).</p>

Section 2:	Safe Work Practices For All Employees	
2.8	Personal Protective Equipment	Effective Date: 1/1/2016 Revised: 3/1/2019
2.8.1 Purpose	This section provides information and safe work practices regarding proper personal protective equipment.	
2.8.2 Responsibilities	<ol style="list-style-type: none"> 1. The Company is responsible for providing personal protective equipment in accordance with all federal and state regulations. 2. The Company is responsible for providing training on when and how to properly use personal protective equipment. 3. The Employee is responsible for complying with the safe work practices outlined in this section. 	
2.8.3 Requirements	<ol style="list-style-type: none"> 1. PPE 2. Respiratory Protection Program 	
2.8.4 Risk Identification	<ol style="list-style-type: none"> 1. Company liability 2. Personal injury or death 	
2.8.5 Safe Work Practices	<ol style="list-style-type: none"> 1. General <ol style="list-style-type: none"> a. Only approved personal protective equipment shall be used. b. Employees shall carefully inspect all personal protection tools and equipment before use. c. Safety equipment found to be defective shall be removed from service and shall be repaired or replaced. d. Refer to Section 5.3 Arc Flash for information on Arc flash clothing. e. Refer to Section 5.6 Protective Rubber Goods and Tools for information on rubber protective equipment. f. Refer to Section 2.10 Fall Protection for information on Fall Protection. 2. Hard Hats <ol style="list-style-type: none"> a. All employees, contractors and visitors shall wear Class I Type E and/or G hard hats when: <ul style="list-style-type: none"> ➤ at construction and maintenance work sites ➤ in substations ➤ exposed to energized circuits ➤ exposed to falling and moving objects ➤ or at any time when an overhead hazard is present <p>Exceptions to hard hat use:</p> <ul style="list-style-type: none"> ➤ reading meters, unless at a construction site or a in a 	

- substation
- inside substation control houses

- b. It is not necessary to wear a hard hat inside buildings unless there is construction or other overhead hazards in the immediate area.
- c. Hard hats shall be properly worn at all times, per manufacturer's recommendations.
- d. Employee hard hats shall not be altered and shall be kept free of all decals and markings, other than those provided and/or approved by the Company.
- e. Hard hats should be discarded and replaced on a 5 year rotation.
- f. All hard hats shall be regularly inspected.
- g. Defective hard hats shall not be worn.

3. Eye and Face Protection

- a. All employees and visitors shall wear Company approved safety glasses when:
 - at construction and maintenance work sites
 - in substations
 - exposed to energized circuits
 - at other places where there is exposure to eye hazards.

Exceptions to Safety glass use are:

- while performing office work.
 - driving a vehicle.
 - during conditions when wearing glasses creates more of a hazard.
 - inside designated areas.
- b. Employees wearing prescription safety glasses shall use approved detachable side protectors (e.g. clip-on or slide-on shields) when there is a hazard from flying objects, or any condition considered hazardous by the employee or supervisor.
 - c. Employees shall wear approved safety glasses with side shields and a face shield whenever there is a hazard from small flying particles, acids, caustics, or any condition considered hazardous by the employee or supervisor.
 - d. Refer to **Section 5.3 Arc Flash** for information on arc flash clothing and face shield requirements.

4. Foot Protection

- a. Employees shall wear ANSI/ASTM-rated protective footwear (safety boots or shoes) when:
 - At construction and maintenance work sites
 - In substations
 - Exposed to energized circuit's
 - Other places where there is exposure to foot

hazards

- b. Clip-on or equivalent protective toe caps may be worn over regular shoes. These will be adequate protection for temporary transitions through areas, lab visits, substation tours, etc. providing the terrain is not irregular.
- c. Protective footwear shall extend above the ankle – except as noted above for temporary clip on or equivalent protective toe caps.

5. Traffic Vests

- a. Employees shall wear a minimum of Class 2 traffic vest/rain gear while working within the road right of way or any other work location where visibility of employee is needed for employee protection.
- b. Employees shall only wear company supplied or approved traffic vests, rain gear and high visibility clothing.
- c. Tattered or worn traffic vests or rain gear where the reflective properties are reduced shall not be worn.

6. Gloves

- a. When protection from mechanical, thermal or electrical hazards is required, gloves appropriate to the task shall be worn.
- b. Cut and puncture resistance gloves shall be worn when such protection is required, this includes but is not limited to:
 - Handling glass
 - Handling sharp metal or wire

7. Ice Cleats (Creepers)

- a. Ice Creepers shall be made available upon request.
- b. When conditions warrant, ice creepers shall be worn to prevent slips and falls.

8. Hearing

- a. Hearing protection shall be worn while working in areas or with equipment where the noise level is equal to or greater than 85 dB.
 - i. Examples of when hearing protection shall be worn include:
 - gasoline chain saws
 - air hammers
 - wood chippers
 - tractors
 - hole diggers
 - emergency generators
 - lawn mowing
 - when in power plants while generators are running etc.
- b. Ear protection is strongly recommended to be worn by employees exposed to noise which seems excessive to them.
- c. Ear muffs shall not be worn when an employee is exposed to an arc

	<p>flash hazard. Inside ear protection is required in these circumstances.</p> <p>d. Contact the Safety Department with questions regarding the appropriate type of hearing protection.</p> <p>9. Life Jackets</p> <p>a. Employees working over or near water shall be provided with a personal floatation device.</p> <p>b. When working over water, life jackets shall be worn and fastened unless the employee is wearing appropriate fall protection.</p> <p>c. Life jackets will be worn at all times when working from any boat, skiff, or barge.</p> <p>10. Respiratory Protection Program</p> <p>a. Refer to Attachment A</p> <p>11. Personal Voltage Detectors (PVD, aka V-Watch)</p> <p>a. All employees who may work in the proximity of high voltage energized wires/equipment while performing the duties of their position shall be provided access to a V-Watch Personal Voltage Detector. Additionally, any employee who feels the need to have a PVD to fulfill their duties with the company may request one from the safety department.</p> <p>b. Before an employee is assigned or provided a PVD, they will be trained in its use and proper application.</p> <p>c. Employees that have been provided and trained in the use and application of a PVD <u>shall</u> use it when performing foot patrols during service restoration.</p> <p>d. Refer to SWP 2.03 V-Watch at the VP Line and Meter web page under Safe Work Practices.</p> <p>12. When in a right of way a hi visibility vest should be worn to prevent being misidentified as game by a hunter during any one of multiple hunting seasons in Maine.</p>
<p>2.8.6 Definitions</p>	

RESPIRATORY PROTECTION PROGRAM

1. General

In accordance with OSHA Standard 29CFR 1910.134, Versant Power (the “Company”) has developed the following Respiratory Protection Program.

The Company’s Safety Compliance Specialist is the program administrator and shall evaluate this Program on a regular basis to ensure that it is effective and meets all applicable regulations.

This Respiratory Protection Program is not intended to relieve the Company of the responsibility to seek engineering methods of eliminating occupational health hazards. Every effort shall be made to control the source of the contaminants. When engineering controls are not feasible or successful, this Respiratory Protection Program shall be followed.

Only respirators and/or cartridge filters supplied by the Safety Department and approved by NIOSH shall be permitted for use. Respirators and/or filter cartridges shall be selected on the basis of the hazards to which the employee is exposed. Factors to be considered are:

- a. The contaminant or hazard itself.
- b. The concentration of the contaminant.
- c. Whether the contaminant is a gas or particulate.
- d. Whether there is immediate danger to life or health.
- e. Maintaining adequate oxygen concentration.

Employees included in the respiratory protection program shall receive training prior to being issued a respirator and annually thereafter. Further training may be required if workplace conditions change. This training shall include the following items, at a minimum:

- a. OSHA Standard 29 CFR 1910.134, including all Appendices
- b. Limitations and capabilities of the respirator
- c. Procedures for inspection, wearing and checking the seal of a respirator
- d. Proper maintenance and storage of the respirator
- e. What to do if the respirator fails during use
- f. How to recognize medical signs and symptoms that may limit or prevent the use of respirators.

2. Medical Evaluation and Fit Testing

Before initial respirator use, employees shall undergo a thorough medical evaluation to determine if they are physically capable of wearing a respirator. After it has been determined that an employee is approved for respirator use, fit testing shall be

performed to ensure the proper respirator is assigned. The employee shall be clean shaven for this fit testing.

Employees shall have their medical status checked annually. Fit testing shall be conducted during this annual check. Fit testing shall also be done anytime there is a different size, style or model of respirator used or if the employee's physical condition has changed (dentures, eyeglasses, obvious weight gain, etc.). Fit tests shall be administered using an OSHA-approved QLFT protocol.

Additional medical evaluations shall be conducted if an employee reports a medical symptom or difficulty while using a respirator.

3. Care and Inspection

Employees shall be responsible for the proper care and maintenance of the respirator assigned to them.

Respirators shall be stored in a clean location. Exposure to heat, sunlight, cold, dust and chemicals can damage respirators. If a respirator is not properly stored, the overall shape or fit of the respirator can be permanently damaged or disfigured.

Respirators shall be inspected before each use. This inspection shall include a check of the tightness of connections and the condition of the facepiece, headbands, valves, connecting tube, and filter cartridges. Rubber or elastomer parts shall be inspected for pliability and signs of deterioration.

Respirators that fail an inspection or are otherwise defective shall be removed from service immediately.

Respirators shall be regularly cleaned and disinfected. At a minimum, respirators shall be cleaned after each day's use.

4. Employee Requirements for Respirator Use

Employees whose work assignment requires that a tight-fitting respirator be worn shall be clean shaven before commencing work.

Work assignments shall not be changed for the sole purpose of permitting an employee to retain a beard. Employees with facial hair shall be prepared to remove it based on the work assignment. Employees refusing to be clean shaven may be subject to disciplinary action.

5. Checking Respirator Seal

Employees shall check the respirator seal before each use with one of the methods below:

- a. Positive Pressure Test: Cover the exhalation valve tightly and exhale gently

into the face piece. The face fit is considered satisfactory if a slightly positive pressure can be built up inside the facepiece without any evidence of outward leakage.

- b. **Negative Pressure Test:** Cover the inlet openings of the cartridge holders sufficiently to prevent any possible air intake, inhale gently so that the facepiece collapses slightly into a collapsed condition and hold breath for 10 seconds. If the facepiece remains in its slightly collapsed condition, and no inward leakage of air is detected, the tightness of the respirator is satisfactory.

6. Approved Respirators and Their Use

The following table lists the tasks requiring respirators and the type of respirator to be used for each task.

Task	RESPIRATOR
SF6 Breaker Maintenance – SF6 gas and its decomposition products (chlorine, fluorine and sulfur gasses) when opening SF6 compartments, until no harmful residue is present.	Air-purifying half-mask respirator with 3M 60922 acid gas cartridge.

7. Voluntary Respirator Use

The Company shall provide a respirator at an employees' request for work that does not require a respirator to be used.

Employees who voluntarily use respiratory protection shall be provided with Appendix D of 29 CFR 1910.134.

The Company shall ensure that employees who use respirators voluntarily are medically able to use the respirator.

Approved respirator for voluntary use is the 3M Particulate Respirator 8514.

8. Recordkeeping

Records pertaining to the Respiratory Protection Program shall be kept by the Safety Department. The following records shall be kept:

- a. Written copy of the respirator program
- b. Medical evaluation records – physicians opinion only
- c. Fit testing records
- d. Training records

Section 2	Safe Work Practices for All Employees	
2.9	Tools and Equipment	Effective Date: 1/1/2016 Revised: 1/31/2020
2.9.1 Purpose	Tools and equipment may be as simple as hammers or as complex as chain saws. Whatever they are, employees must use them safely to avoid the risks that they pose. The purpose of this section is to provide information and safe work practices for tools and equipment.	
2.9.2 Responsibilities	<ol style="list-style-type: none"> 1. The Company is responsible for providing safe tools and equipment. 2. The Company is responsible for training employees on the safe use of tools and equipment. 3. Employees are responsible for properly using safe tools and equipment. 	
2.9.3 Requirements	<ol style="list-style-type: none"> 1. PPE 2. Training as applicable 	
2.9.4 Risk Identification	<ol style="list-style-type: none"> 1. Personal injury from using unsafe tools and equipment or using them improperly. 2. Pressurized hazards caused by hydraulic or pneumatic tools. 3. Serious injury or death from moving or rotating parts. 	
2.9.5 Safe Work Practices	<ol style="list-style-type: none"> 1. General <ol style="list-style-type: none"> a. Proper PPE shall be worn when using tools and equipment. b. Tools and equipment shall be used only for the purpose for which they are designed. c. Employees shall not use damaged, defective or unapproved tools and equipment. d. Tools and equipment shall not be modified. e. Guards or other safety devices on tools and equipment shall not be removed or rendered inoperative. f. Keep all body parts out of the line of fire when using tools and equipment. g. Keep all body parts and other employees out of the path of flying debris. h. When handling heavy tools or equipment, sufficient help shall be obtained to assist with lifting, positioning, etc. i. Tools and equipment shall be cleaned and properly stored after use. j. Employees shall not use conductive tapes or rules while working on or near energized equipment or lines. k. Fuel powered equipment shall only be used in a well-ventilated area. 2. Inspection and Maintenance <ol style="list-style-type: none"> a. All tools and equipment shall be inspected before use. 	

- b. The manufacturer's recommendations shall be followed when using or servicing tools and equipment.
- c. Any tool or equipment found defective shall have a gray defective/repair tag applied, and then the item shall be discarded, repaired or replaced.

3. Throwing or Dropping Tools

- a. Employees shall not throw or drop tools.
- b. Employees shall use suitable hand lines, tool bags, tool buckets or other proper receptacles for raising or lowering tools.
- c. When working aloft, refer to **Section 3.5 Insulated Aerial Lifts**.

4. Hydraulic and Pneumatic Tools

- a. The manufacturer's safe operating pressures for tools, hoses, valves, pipes, filters, and fittings shall be observed.
- b. Prior to use, inspect hoses for any possible defects and place them in a location to avoid any damage while in use.
- c. Pressure shall be released before breaking connections, unless using quick acting self-closing connectors.
- d. Hoses shall not be used for hoisting or lowering tools.
- e. All compressed air hoses exceeding 1/2 inch inside diameter shall have a safety device at the source of supply or branch line to reduce pressure in case of hose failure.

5. Extension Cords, Ground Fault Circuit Interrupters ("GFCI"), Work Lights

- a. All extension cords shall be three-wire, three-prong and be of the proper gauge for the application, and should not be modified from the original design.
- b. Extension cords with cuts, frayed wires and defective or missing grounding prongs shall not be used.
- c. GFCI protection shall be required when using electrical tools and equipment.
- d. Work lights shall not be used without a proper bulb guard in place.
- e. Bulbs shall not exceed the maximum wattage of the work light.
- f. The use of electric cords for hoisting or lowering tools or other equipment shall not be permitted.

6. Electric Hand Tools

- a. Power source should be removed prior to servicing an electric power tool.
- b. Prior to use, inspect tool power cords for cuts or frays.
- c. Only electrically powered hand tools with original cord and plug shall be used.

7. Chain Saws

- a. Follow the manufacturer's instructions for operation and adjustment.

- b. Only employees who have received training and are deemed qualified shall use chain saws.
- c. All chain saws shall be equipped with a properly functioning chain brake.
- d. Required PPE includes:
 - i. hard hats
 - ii. safety glasses
 - iii. hand protection
 - iv. leg protection unless working in a bucket
 - v. foot protection
 - vi. hearing protection
- e. Chain saws shall be started with the chain break engaged and properly tested. The following methods are acceptable for starting a chain saw:
 - i. Starting with the saw on the ground: support with your right foot in the rear handle and keep a firm grip on the front handle with your left hand.
 - ii. Starting with the saw between your legs: place the rear handle between your left thigh and behind your right knee. Hold the front handle firmly with your left hand.
 - iii. Starting the chainsaw from the bucket is allowed providing the saw is not pushed away with one hand when pulling the starter cord with the other (defined by OSHA as drop starting). The area around and below the saw (to the ground) must be clear when starting to prevent contact with saw from inadvertent movement or dropping of saw.
- f. Ensure your footing is secure prior to starting a chain saw.
- g. All chain saws shall be shut off while being refueled, serviced or maintained.
- h. Refueling shall take place at least 10 feet from any ignition source.
- i. Only the operator shall be in close proximity of the chain saw when in use.
- j. When not in use the chain saw shall be properly stored with a scabbard or in a case.
- k. Only wood shall be cut with a chain saw.

8. Hand Tools

- a. Hand tools shall only be used for the purpose for which they are designed.
- b. Pipe or other extensions shall not be used to increase leverage unless the tool is specifically designed for such use.
- c. Use care when swinging tools to ensure sufficient clearances.
- d. When not in use, axe blades shall be properly sheathed or covered with a protective guard.

9. Grinders & Hammer drills

- a. A suitable guard must cover the grinder disk.

	<ul style="list-style-type: none"> b. Safety glasses and full-face shield shall be worn when using grinders. c. Grinder disks shall be inspected prior to use and if found to be defective shall not be used. d. Use proper technique when operating a grinder. e. Keep body parts and other employees out of the path of flying debris. f. Handheld grinders shall come to a complete stop before being placed on the floor or worktop surface. g. Bench grinder work rests shall be used to support the work and shall be adjusted to within 1/8" of the wheel. h. Bench grinder tongue guards shall be periodically adjusted to within 1/4" of top of wheel. i. Side handles provided with Grinders or Hammer drills must be used. <p>10. Machine Guarding</p> <ul style="list-style-type: none"> a. All belts, pulleys, gears, shafts and other moving parts of machines shall be guarded. b. Guards shall only be removed for servicing. c. All portions of band saw blades shall be enclosed or guarded, except for the working portion of the blade between the bottom guide rolls and the table. <p>11. Machine Shop</p> <ul style="list-style-type: none"> a. Machine Shop area shall be kept free from waste and excess material. b. Loose clothing and jewelry shall not be permitted while working in the machine shop. c. The frame and all exposed non-current carrying metal parts of electrically powered machines shall be effectively grounded. d. Power controls and operating controls of shop equipment should be located within easy reach of the operator. e. All tools and materials shall be securely fastened on the work bench to prevent inadvertent movement while being worked on. f. Hot materials shall not be left unattended.
<p>2.9.6 Definitions</p>	<p><i>Qualified: a person who, by possession of a recognized degree, certificate, or professional standing, or who by extensive knowledge, training and experience, successfully demonstrates the ability to solve problems relating to the subject matter, the work or the project.</i></p>

Section 2	Safe Work Practices for All Employees	
2.10	Fall Protection	Effective Date: 1/1/2016 Revised: 1/1/2017
2.10.1 Purpose	Fall protection equipment is necessary to protect employees engaged in work activities that expose them to potential falls from heights. This section provides regulatory requirements and general guidelines regarding fall protection systems and their use.	
2.10.2 Responsibilities	<ol style="list-style-type: none"> 1. The Company is responsible for providing proper fall protection equipment. 2. The Company is responsible for providing training on the use of fall protection systems. 3. Employees are responsible for following the safe work practices. 	
2.10.3 Requirements	<ol style="list-style-type: none"> 1. Inspected and approved fall protection equipment 2. Training 	
2.10.4 Risk Identification	<ol style="list-style-type: none"> 1. Personal injury or death caused by falling from heights. 2. Inadequate training or equipment resulting in company liability. 	
2.10.5 Safe Work Practices	<ol style="list-style-type: none"> 1. Fall Protection Lifesaving Rules: <ol style="list-style-type: none"> a. Employees shall use fall protection when working more than four feet above a lower level for the following conditions: <ol style="list-style-type: none"> i. when in an aerial lift unit ii. when standing on substation structures and equipment iii. when climbing and working from a pole 2. General <ol style="list-style-type: none"> a. Fall protection shall be required whenever an employee is working four or more feet above a lower level. b. For fall protection requirements when working from a ladder, refer to <i>Section 2.11 Ladders and Scaffolding</i>. c. A Risk Assessment shall be conducted whenever fall protection is required. d. A rescue strategy shall be discussed during the Risk Assessment any time workers are utilizing personal fall arrest systems. e. All personal fall arrest systems shall be properly stored when not in use. f. Clear distance requirements which protect the worker from striking the surface below shall be calculated per OSHA standards. (Title 29 CFR 1926.502). g. Fall protection devices shall be inspected regularly. h. Unprotected sides or edges of walking/working surfaces that are 	

more than four feet above a lower level shall have fall protection in place such as, guard rails, perimeter guarding, fall restraint systems or personal fall arrest systems.

- i. Guard rail protection systems shall be constructed to withstand a 200 pound load applied in any direction.
- ii. Temporary perimeter guarding shall be capable of withstanding a 200 pound load applied in any direction.
- iii. When fall restraint is utilized, the employee shall wear a full body harness tied off to an anchor capable of supporting 5,000 pounds.
- iv. When fall restraint is utilized, it shall be installed so that an employee cannot fall more than six feet or contact any lower level.

3. Personal Fall Arrest Systems - Poles

- a. Employees shall use a Company provided pole choker device when climbing a pole.
- b. To maintain 100% fall protection while climbing poles, employees shall also use a transition lanyard.
- c. Employees shall be trained on the proper use of the pole choker devices.
- d. Employees are required to annually complete refresher training and demonstrate proficiency in pole climbing.

4. Personal Fall Arrest Systems – Other than Poles

- a. Anchorage
 - i. A certified anchor shall be able to hold 5,000 pounds.
 - ii. Anchors shall be located so that free-fall distance and swing-fall hazards are minimized and rescue is easily facilitated.
 - iii. Anchors shall be as high as possible and maintain a vertical position to provide adequate protection to the employee.
- b. Anchorage Connectors
 - i. All snaphooks shall have ANSI-rated 3,600 pound gates and double-action locks.
 - ii. All connections between anchors and PPE shall be compatible.
- c. Bucket Self-Rescue Device
 - i. A bucket self-rescue device shall be available while an employee is working aloft.
 - ii. The bucket self-rescue device shall be the appropriate rating.
 - iii. All required employees shall be trained in bucket self-rescue at the time of initial aerial lift use and annually thereafter.
- d. Shock Absorbing Lanyards
 - i. Employees shall use a shock absorbing lanyard.

	<p>provided by the Company when not an integral part of the fall protection device.</p> <ul style="list-style-type: none"> ii. Employees shall use the appropriate rated shock absorbing lanyards for the fall distance. iii. To maintain 100% fall protection employees shall also use a transition lanyard. <ul style="list-style-type: none"> e. Full Body Harness <ul style="list-style-type: none"> i. Harnesses issued by the Company shall be ANSI approved. ii. Harnesses shall be properly worn at all times. f. Self-Retracting Lifelines (SRL) <ul style="list-style-type: none"> i. SRL's shall be connected directly to the dorsal d-ring of the full-body harness. ii. SRLs shall be used in accordance with manufacturer's guidelines. <p>5. Inspection and Maintenance</p> <ul style="list-style-type: none"> a. Fall protection PPE shall be inspected prior to use. b. Damaged or defective fall protection shall be immediately removed from service. c. Fall protection equipment subjected to a fall shall be taken out of service. d. Fall protection PPE shall be inspected annually by a qualified third party inspector. e. After a successful annual inspection, a plastic zip-tie shall be attached to the harnesses. <ul style="list-style-type: none"> i. In odd-numbered years, the zip-tie shall be fluorescent lime yellow. ii. In even-numbered years, the zip-tie shall be fluorescent orange. f. Fall protection components without a zip-tie attached shall be reported to the Safety Department for re-inspection. g. All labels attached to fall protection shall be legible. <p>6. Training</p> <ul style="list-style-type: none"> a. All employees required to use fall protection shall receive training. b. All employees shall be properly trained and qualified prior to being exposed to fall hazards. c. Proper documentation of training shall be maintained.
<p>2.10.6 Definitions</p>	<p>Anchorage: a secure point of attachment for lifelines, lanyards and/or deceleration devices.</p> <p>Bucket self-rescue device: a fall restraint system that a person can use to lower themselves from a bucket to the ground in the event the lift becomes inoperable.</p> <p>Fall Restraint: utilizing a properly worn full-body harness in conjunction</p>

	<p>with lifeline or lanyard that prevents an employee from reaching the edge of a walking/working surface and falling.</p> <p>Lower Level: an area or surface to which an employee can fall. Such areas or surfaces include, but are not limited to, ground levels, floors, platforms, ramps, runways, driveways, excavations, pits, tanks, water, equipment, structures, mud, etc.</p> <p>Personal Fall Arrest System: a system of components that, in the event of a fall, prevents the employee from striking the surface below the level from which he/she fell. A personal fall arrest system consists of a properly worn full body harness, a shock absorbing lanyard and a point of anchorage.</p> <p>Pole Choker Device: a fall restraint device to prevent the worker from falling while climbing a pole.</p> <p>Transition Lanyard: a secondary fall restraint device which is used when the primary device needs to be removed to pass over an obstacle while climbing a structure</p>
--	---

Section 2	Safe Work Practices for All Employees	
2.11	Ladders and Scaffolding	Effective Date: 1/1/2016 Revised: 1/1/2017
2.11.1 Purpose	Working from heights is a high risk activity. Improper use of ladders and scaffolding can result in serious injuries or death. This section provides information and safe work practices when using ladders and scaffolding.	
2.11.2 Responsibilities	<ol style="list-style-type: none"> 1. The Company is responsible for providing ladders and scaffolding equipment. 2. The Company is responsible for providing training on inspection and proper use of ladders and scaffolding. 3. Employees are responsible for following all safe work practices. 	
2.11.3 Requirements	<ol style="list-style-type: none"> 1. PPE 2. Fall Protection, if necessary 3. Ladders appropriate for the task 	
2.11.4 Risk Identification	<ol style="list-style-type: none"> 1. Personal injury or death caused by falling from heights or improper handling of ladders or scaffolding. 2. Hand injuries when setting up ladders or scaffolding. 3. Unsecured or shifting of ladders or scaffolding. 4. Risk of electrical contact when handling ladders. 	
2.11.5 Safe Work Practices	<ol style="list-style-type: none"> 1. General <ol style="list-style-type: none"> a. Only Company supplied ladders shall be used. b. Ladders shall be inspected before use. c. Damaged or defective ladders shall not be used and shall be gray tagged out of service. d. The load rating of ladders shall not be exceeded. e. Where practical, tie the ladder to the supporting structure. f. Three points of contact shall be maintained while ascending or descending. g. Only use approved ladder attachments and accessories. h. Do not place a ladder in front of a door unless the door is blocked open, locked or guarded. i. Face the ladder when ascending or descending. j. Employees shall keep their body centered on the ladder. As a general rule the belt buckle should never cross a vertical rail. k. Ladders shall always be placed on a stable base. l. Ladders shall not be used in a horizontal position as platforms, runways or scaffolds unless marked by the manufacturer for that purpose. m. Only one employee shall work on the ladder at a time, unless it is designed by the manufacturer for more than one person. n. Employees shall not stand above the highest safe standing level 	

marked on the ladder.

- o. Ladders shall be laid down when not in use unless securely tied.

2. Extension Ladders

- a. When used on smooth or slippery surfaces, extension ladders shall be held by another person at the foot or firmly secured.
- b. To ensure that the ladder is at the correct angle:
 - i. place your toes against the bottom of the ladder side rails
 - ii. stand erect with your arms straight out to the front
 - iii. the palms of your hands should touch the top of the rung at shoulder level
- c. If required to work from an extension ladder, the ladder shall be securely tied at the top to a fixed structure if possible.
- d. If the ladder is secured to the structure, fall protection should be used for two-hand work from the ladder.
- e. A ladder inserted into a manhole, vault, tank etc. should be held steady at the top while an employee is ascending or descending.
- f. When used to gain access to surfaces to be walked upon, at least three feet of the ladder shall extend above the level of the higher surface.
- g. Employees shall not carry anything up or down the ladder that may interfere with the use of their hands.

3. Step Ladders

- a. Stepladders shall only be used when fully opened with braces locked in place.
- b. Tools and other materials shall not be left on the top or on the steps of ladders.
- c. Tools and materials may be placed on the paint shelf of a ladder not more than eight feet tall.
- d. Employees shall not sit on the top of the step ladder.
- e. Do not climb on the back of a single-sided step ladder.

4. Fixed Ladders

- a. Fixed ladders shall be inspected before each use.
- b. Fixed ladders greater than 20 feet long shall be installed with a fall protection device or a cage.

5. Scaffolds

- a. All scaffolds shall be erected in accordance with requirements of this section. Any circumstance not covered by this section shall comply with 29 CFR 1910.28 and 1926.451.
- b. The footing for scaffolds shall be sound, rigid and capable of carrying the maximum intended weight.
- c. Guardrails and toe boards shall be installed on all open sides and ends of platforms more than ten feet above the ground or floor.
- d. Fall protection shall be worn by employees working from a scaffold more than four feet above the ground unless a guardrail

	<p>is installed. A toe board is not required at 4 feet but is required at 10 feet and above.</p> <ul style="list-style-type: none"> e. Guardrails shall be 2" x 4" wooden board or equivalent material, approximately 42 inches high, with a mid-rail at the half way point between the rail and platform. Supports shall be at intervals not to exceed eight feet. Toe boards shall be a minimum of four inches in height. f. Any scaffold components that are found to be damaged or weakened shall be immediately repaired or replaced. g. All planking shall be scaffold grades or equivalent. All planking will meet the OSHA standards as referenced above. h. An access ladder or equivalent safe access shall be provided.
<p>2.11.6 Definitions</p>	

Section 2	Safe Work Practices for All Employees	
2.12	Confined Space Entry Policy	Effective Date: 1/1/2016 Revised: 1/1/2018
2.12.1 Purpose	The purpose of this policy is to provide safe work practices regarding confined space entry to ensure the protection of all employees from the hazards while in confined spaces.	
2.12.2 Responsibilities	<ol style="list-style-type: none"> 1. The Company is responsible for: <ol style="list-style-type: none"> a. Identifying all confined spaces that employees could be exposed to. b. Ensuring proper signage on all confined spaces and/or adequate means of preventing unauthorized entry into confined spaces. c. Providing information to employees about confined spaces. d. Establishing and implementing a written program to manage confined spaces. e. Establishing and implementing an entry permit for entry into confined spaces. f. Establishing and implementing contractor entry procedures. 2. Employees are responsible for following the procedures established by the Company. 	
2.12.3 Requirements	<ol style="list-style-type: none"> 1. Confined Space Entry Permit 2. Risk Assessment Form 3. Air Monitor(s) 4. Personal Protective Equipment 5. Rescue Equipment 6. Two-way Radios 7. Ventilation Equipment (including Generator) 8. Manhole Lifting Device 9. Road Signs, Cones, Traffic Barricades 10. Appropriate Ladder 11. Lighting 	
2.12.4 Risk Identification	<ol style="list-style-type: none"> 1. Serious injury or death due to electrical contact. 2. Traffic around the work zone. 3. Falling into an un-barricaded manhole. 4. Improper lighting conditions creating potential for injury. 5. Engulfment and asphyxiation due to gas exposure or flooding 	
2.12.5 Safe Work Practices	<ol style="list-style-type: none"> 1. Confined Space Lifesaving Rules <ol style="list-style-type: none"> a. Do not enter a confined space until an entry permit has been completed. 	

- b. The attendant shall not leave the immediate area of the confined space while it is occupied.
- c. An air monitor shall be located in the confined space at all times while it is occupied.
- d. Entrants shall wear rescue harness at all times.
- e. Rescue Equipment shall be in place at all times.

2. General

- a. The Confined Space Entry Permit (Attachment A) shall contain the OSHA required parameters for hazard identification and testing.
- b. No more workers than are necessary to perform the work shall be permitted in a confined space.
- c. A ladder should be used to enter a confined space deeper than five feet.
- d. Prior to entry, rescue equipment shall be set up in place and in good working condition.
- e. All employees working in a confined space shall wear an emergency rescue harness at all times.
- f. A safety line shall be attached to the rescue harness if not accessible with the stick-applied rescue line.
- g. After removing a confined space cover, the opening shall be properly barricaded.
- h. The attendant shall keep all tools and equipment a safe distance from the opening.
- i. Before lowering tools or materials into the opening, ensure the area below is clear.
- j. The work site shall be set up appropriately. Refer to **Section 3.4 Operating in Traffic** for information on operating in traffic.

3. Training

- a. Employees exposed to the hazards of confined spaces shall receive appropriate training at the time of initial assignment.
- b. Refresher training shall be conducted annually or as needed to maintain competency.
- c. Training shall be conducted when changes to procedures are made, when a training need is identified or when a deviation from this policy occurs.

4. Duties of Employees

- a. Authorized entrant shall:
 - i. Know the hazards of confined spaces.
 - ii. Recognize the signs, symptoms and consequences of confined space hazards.
 - iii. Know the proper use of confined space entry equipment.
 - iv. Understand how to communicate with the attendant.
 - v. Alert the attendant at the initial sign of danger and exit

the confined space as soon as possible.

b. Authorized attendant shall:

- i. Stay within the immediate area and outside of the confined space at all times to:
 - Monitor the entrants.
 - Watch for hazards internal or external to the confined space.
 - Keep unauthorized persons away from the confined space.
 - Conduct non-entry rescue and/or summon rescue services.
- ii. Know and recognize hazardous conditions.
- iii. Know and recognize the possible behavioral effects of exposure to hazardous conditions.
- iv. Maintain an accurate count of authorized entrants.
- v. Remain in the immediate area of the confined space until work is complete or another authorized attendant arrives.
- vi. Maintain communication with the entrants.
- vii. Order evacuation if an entrant exhibits exposure effects or other hazards are detected.
- viii. Attendants may perform other duties provided those duties do not distract from the primary duties noted above.
- ix. Maintain communication with contracted rescue services as necessary.

c. Entry supervisor shall:

- i. Know the confined space hazards.
- ii. Verify all permit and entry conditions.
- iii. Secure the confined space and close the entry permit when required.
- iv. Verify the availability and means to summon rescue services.
- v. Remove unauthorized persons from the work area.
- vi. Ensure proper shift transfer procedures are conducted.

5. Confined Space Rescue

- a. Employees trained in confined space rescue must practice making permit space rescues before attempting an actual rescue, and at least once every 12 months.
- b. Any time employees enter a confined space a plan to conduct the rescue of those employees shall be part of the entry permit.
- c. Under no circumstances is the attendant to enter the confined space.
- d. The only rescue employees are trained or authorized to conduct is non-entry rescue utilizing the retrieval pole and winch or a

tripod and winch.

- e. If the confined space job requires rescue techniques beyond Company employee capabilities the Safety Department shall identify in advance a municipal rescue service or contract with a properly trained entity to provide the entry rescue service. The rescue service provider must give the authorized attendant notice if they are unable to respond for a period of time (the municipality may be responding to another emergency.)

6. Entry Procedure

- a. The work that needs to be conducted shall be determined.
- b. The entry permit (Attachment A) shall be completed along with a tailboard briefing and Risk Assessment before entering a confined work space.
- c. Conduct all required work that can be done outside of the confined space first.
- d. Air tests shall be conducted at the top, middle and bottom of the confined space prior to entry. The air monitor shall be bump tested with cal gas prior to use.
- e. An air monitor shall be located in the confined space at all times while it is occupied.
- f. After the confined space has been unoccupied for a period of 30 minutes or longer an air test shall be performed prior to entry.
- g. Mechanical ventilation shall be used for the duration of the work when an air test shows a hazardous condition.
- h. The attendant shall monitor mechanical ventilation equipment when in use.
- i. Continuous mechanical ventilation and monitoring shall be used any time welding, cutting or grinding is being conducted in a confined space.
- j. The time of entry into and out of the confined space shall be documented.
- k. After work is completed, the confined space shall be secured and the entry permit closed.
- l. A copy of the closed entry permit shall be maintained by PST for 1 year.

7. Contractor Procedures

- a. The Company shall provide contractors with the applicable policies and procedures.
- b. Contractors are required to follow all Company policies and procedures.
- c. The Company shall review with contractors all identified hazards.
- d. The Company shall be responsible for making sure workers (contractors or employees) outside a confined space know not to create hazards in the space. (for example running a generator near the confined space entrance which could cause a buildup of carbon monoxide within the space)

	<p>e. The Company shall coordinate a debriefing upon closure of the Entry Permit.</p>
<p>2.12.6 Definitions</p>	<p>Authorized Attendant: an individual stationed outside one or more confined spaces who monitors the authorized entrants and who performs all attendant's duties. An Authorized Attendant also may serve as an Authorized Entrant or Entry Supervisor. An Authorized Attendant shall <u>never</u> serve simultaneously as an Entrant.</p> <p>Authorized Entrant: an employee who is authorized by the employer to enter a confined space. An Authorized Entrant may also serve as an Attendant or as an Entry Supervisor.</p> <p>Confined Space: a space that:</p> <ol style="list-style-type: none"> 1. Is more than five feet deep; or 2. Is large enough that an employee can enter and perform assigned work; and 3. Has limited or restricted means for entry or exit; and 4. Is not designed for continuous employee occupancy. <p>Entry Permit: the written or printed document that is provided by the employer to allow and control entry into a confined space and that contains the information specified in OSHA 1910.146.</p> <p>Entry Supervisor: the person responsible for authorizing entry, overseeing entry operations and terminating the entry. An entry supervisor also may serve as an attendant or as an authorized entrant. The duties of entry supervisor may be passed from one individual to another during the course of an entry operation.</p> <p>Immediate Area: close enough to the work location so that the attendant can perform all the assigned duties.</p>

Confined Space Entry Permit

Location and Description of Confined Space _____

Suspected Hazards _____

Date/Time of Authorization _____ Expires _____

Purpose of Entry _____

Authorized Supervisor(s)	Authorized Entrants	Authorized Attendants

Special Requirements	Yes	No
*Air Monitors		
Hot Work Permit		
Lock/De-energize		
Tagout		
Ventilation		
Ladder		
Fire Extinguisher		
Protective clothing		
MH Cover Removal		
Portable Radio		
Rescue Service contacted		

Special Requirements	Yes	No
*Monitor Bump Test		
Tripod Barrier		
*Tripod/Retrieval Device		
Retrival Pole		
*Harness		
Tethering Ropes		
Water Pump		
GFCI lighting		
Traffic Barricade		
Traffic Signs		
Flaggers		

If yes on Rescue Service list contact info: _____

Required Tests	P.E.L.	Reading		Time		Reading		Time	
Percent of Oxygen	19.5% - 23.5%								
Percent of L.E.L.	<10%								
Carbon Monoxide	<35PPM								
Other									

Signature of Entry Supervisor _____ Date _____

(Print and Sign)

Comments:

* Mandatory

Entrant Log

Authorized Entrant	Time In	Time Out	Time In	Time Out	Time in	Time Out

SJOR

1. Job Location, Date & Time

2. Nature of Job

3. List the hazards for this task/job

4. Did the crew identify

the same hazards? Yes No

5. What are the proper barriers to control/eliminate the hazards listed?

6. Are "Control Barriers" in place for all High Risk Hazards?

Yes No

7. Risk Assessment reviewed with all crew members on the job?

Yes No

8. All vehicles, equipment and tools used in good condition?

Yes No

If no, explain

9. Are all work practices in compliance with established safe work practices?

Yes No

10. Is all PPE in use in good condition and appropriate for job?

Yes No

Supervisor Name/Signature

Crew Signatures & Comments:

Section 2	Safe Work Practices for All Employees	
2.13	Eyewash Stations	Effective Date: 1/1/2016 Revised:
2.13.1 Purpose	Emergency eyewash stations are necessary to minimize the effects of accidental exposure to chemicals or other work place eye hazards. The purpose of this section is to provide information on the use and care of emergency eyewash stations.	
2.13.2 Responsibilities	<ol style="list-style-type: none"> 1. The Company is responsible for providing emergency eyewash stations in locations where an employee's eyes may be affected by exposure to a hazardous substance. 2. The Company is responsible for oversight of the inspection and maintenance of emergency eyewash stations. 3. The employee is responsible for knowing the location of emergency eyewash stations in areas where they work. 	
2.13.3 Requirements	<ol style="list-style-type: none"> 1. Eyewash stations that shall provide a minimum of 15 minutes of flushing time. 2. SDS information on chemicals. 	
2.13.4 Risk Identification	<ol style="list-style-type: none"> 1. Eyewash station not in working order. 2. Eyes not properly flushed resulting in further eye damage. 3. Not understanding the Safety Data Sheet (SDS) information. 	
2.13.5 Safe Work Practices	<ol style="list-style-type: none"> 1. General <ol style="list-style-type: none"> a. Employees shall be familiar with the location of eyewash stations in the vicinity of their work. b. Employees shall be familiar with the operation of eyewash stations. c. Eyewash stations shall be easily accessible and located within a ten second walk of the hazardous location. d. The area around eyewash stations shall be kept clear of obstructions. e. Covers shall be kept on nozzles to prevent contamination. f. Activated eye wash stations shall be reported immediately after use for maintenance. g. Employees shall be familiar with the SDS for each chemical to be used or handled. 2. Use of Emergency Eyewash Stations <ol style="list-style-type: none"> a. Eyewash stations may be used for both chemical or dust/particulate irritation. b. While using an eyewash station hold eyes open fully to maximize flushing. 	

	<ul style="list-style-type: none"> c. Flushing of the eyes contaminated with any mild chemical solution should be a minimum of 15 minutes. d. Flushing of the eyes contaminated with inert dust or debris should be a minimum of five minutes. e. Flushing of the eyes contaminated with any strong corrosive or strong base may require longer flushing. f. Employee shall seek medical attention following an incident. g. If possible, continue flushing while on the way to medical help. h. The mobile eyewash stations shall be prepared and maintained according to the manufacturer’s recommendations. <p>3. Inspection of Eyewash Equipment</p> <ul style="list-style-type: none"> a. Inspection of all eyewash stations shall be done on a monthly basis. b. Visual inspection of the eyewash station shall determine if the station is accessible, clean and whether the fluid needs to be changed.
<p>2.13.6 Definitions</p>	<p>Mobile Eyewash Station: portable eyewash station that is designed for transportation between job sites.</p> <p>Safety Data Sheet (SDS): a formal document containing important information about the characteristics and actual or potential hazards of a substance.</p>

Section 2	Safe Work Practices for All Employees	
2.14	Excavating and Trenching	Effective Date: 1/1/2016 Revised: 1/1/2017
2.14.1 Purpose	Excavating and trenching are among the most hazardous construction operations. This section provides information and safe work practices when working in an excavated or trenched area.	
2.14.2 Responsibilities	<ol style="list-style-type: none"> 1. The Company is responsible for hiring qualified contractors to perform excavation and trenching operations. 2. The Company is responsible for providing oversight to the excavation and trenching operations. 3. The Company shall ensure that only properly qualified employees operate equipment. 4. The employee is responsible for operating the equipment safely. 	
2.14.3 Requirements	<ol style="list-style-type: none"> 1. Company approved contractor 2. PPE 3. Dig Safe Ticket 4. Excavation and trenching equipment 5. Proper work zone set-up 	
2.14.4 Risk Identification	<ol style="list-style-type: none"> 1. Cave-in of excavation 2. Damage to underground utilities 3. Personal and public safety while heavy machinery is in operation 4. Excavating without proper authorization. 	
2.14.5 Safe Work Practices	<ol style="list-style-type: none"> 1. Dig Safe Authorization <ol style="list-style-type: none"> a. No excavation or trenching shall be conducted until a Dig Safe Ticket has been submitted and approved and all relevant utilities have been notified and their facilities located. b. Emergency excavation or trenching may begin once an emergency Dig Safe Ticket has been submitted and approved. 2. General <ol style="list-style-type: none"> a. Any excavation or trench shall conform to OSHA Standards. b. For information regarding proper excavation and trenching techniques refer to Attachment A. c. Mechanical excavating or trenching equipment shall be used only in areas where there is no known danger of coming into contact with or damaging underground facilities. d. Persons working in excavations or trenches shall be protected from cave-in by an adequate protective system (sloping, stepped, trench box) except when: <ol style="list-style-type: none"> i. Excavations are less than five feet deep and examination of the ground provides no indication of potential cave-in, 	

or

- ii. Excavations are less than five feet deep and are made entirely of stable rock.
- e. When employees are required to be in excavations or trenches four feet deep or more an adequate means of exit, such as a ladder or steps, shall be provided and located within twenty-five feet of the employee.
- f. Ladders placed into an excavation or trench shall extend 36 inches above the excavation.
- g. No more trench than is necessary shall be open.
- h. Poles shall be supported by digger derrick or by other means when trenching disturbs soil adjacent to the pole.
- i. At the end of each day's work, as much of the trench as practical shall be closed.
- j. When excavations or trenches are left open, warning devices, barriers, barricades or guard rails shall be placed to adequately protect the public and employees.
- k. An unattended excavation or trench shall be inspected prior to beginning work.
- l. In an effort to preserve the excavation or trench, water shall not be allowed to accumulate while working in the excavation or trench.
- m. Support systems shall be planned and designed by a Professional Engineer when the excavation or trench is more than twenty-feet in depth.
- n. Excavated material shall not be placed less than two feet from the edge of excavations and trenches and shall be no more than five feet in height.
- o. Whenever excavating or trenching is done in close proximity to underground facilities, it shall be done only by hand digging or other approved means.
- p. When working around energized lines and equipment the operator shall observe the minimum approach distance for cranes. Refer to ***Section 5.4 Minimum Approach Distances***.

3. Damaged Underground Utilities

- a. If electric cables are damaged during excavation or trenching, notify Central Dispatch, System Operations or the supervisor and barricade the area.
- b. If communication cables are damaged during excavation or trenching, System Operations or Central Dispatch shall be notified.
- c. If gas lines are damaged during excavation or trenching, the following steps shall be taken:
 - i. Evacuate the excavation as fast as possible.
 - ii. Dial 911.
 - iii. Notify System Operator or Central Dispatch.
 - iv. Residents of the area shall be warned when necessary

	and the public kept out of the area.
2.14.6 Definitions	<p>Dig Safe: a clearing house that notifies participating utility companies of planned digging activities.</p> <p>Excavation: a cavity formed in the ground by cutting, scooping or digging.</p> <p>Trenching: any long, deep and narrow hole cut in the ground.</p>

Type C Soils Include:

1. Cohesive soil with UCS less than .5 T/SF.
2. Granular soils including gravel, sand and loamy sand.
3. Saturated or submerged soils.
4. Type "A" and "B" soils that are not classified by the S&H Department.

Type C Soil Slope Excavation

Depth	Width
8 ft	28 ft
10 ft	34 ft
12 ft	40 ft
14 ft	46 ft
16 ft	52 ft
18 ft	58 ft
20 ft	64 ft

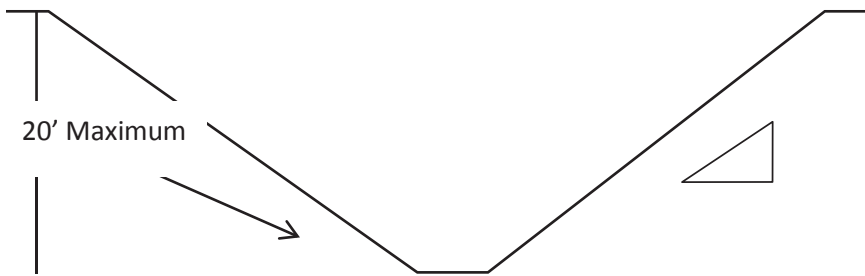

Type C Soil Supported or shielded Vertically sided lower portion

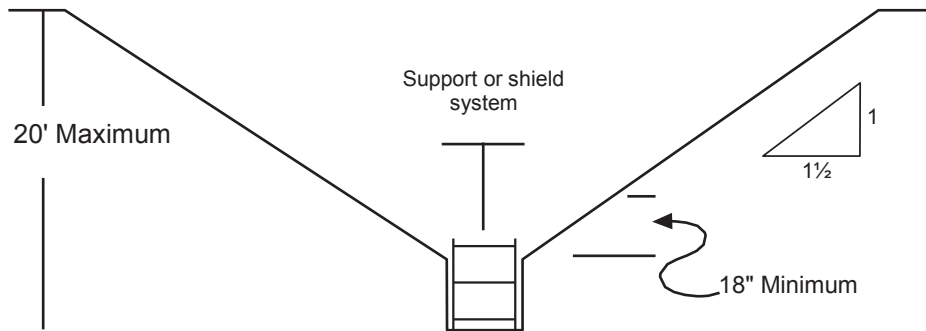

Using Road Plates to cover an Excavation or Trench:

Plate Size	Dimension "A" Max Trench Width	Dimension "B" Max Trench Width
5' x 12'	3'	6'
8' x 12'	6'	8'
8' x 16'	6'	8'
8' x 20'	6'	8'

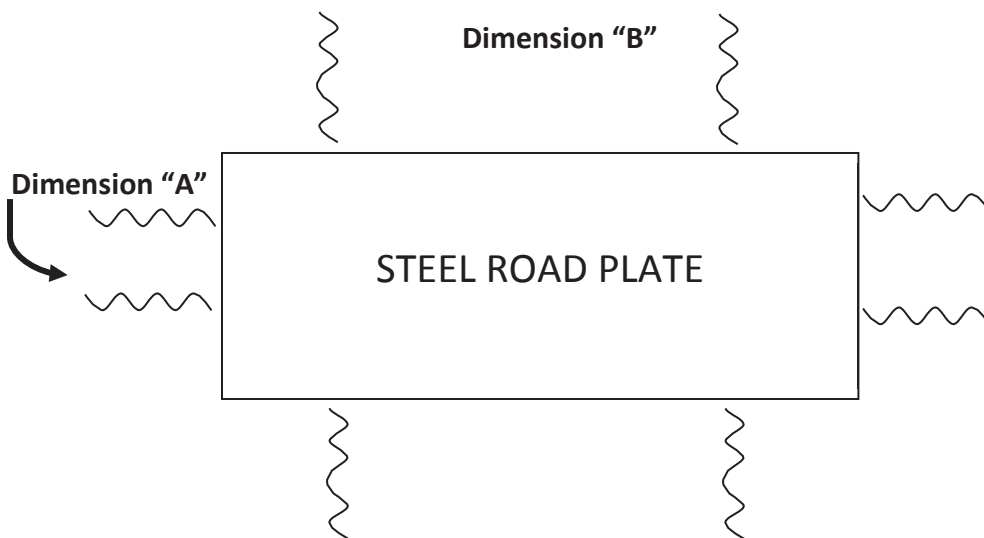

Securing Road Plates

- If possible, excavations should be back filled to protect the public and site.
- If road plates are used to cover an open excavation, secure all road plates to the surface to prevent them from shifting and creating a hazard to the public.
- The current method of securing road plates is the use cold patch on all sides of the plate.

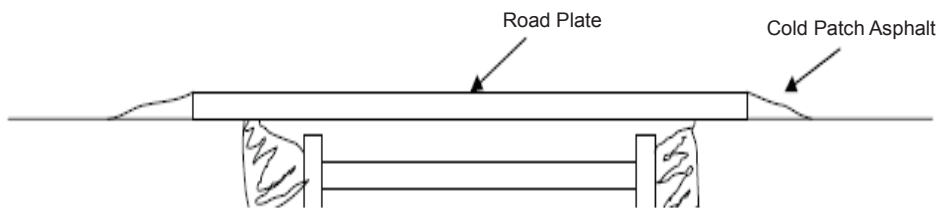

TRENCH SAFETY BEST PRACTICES

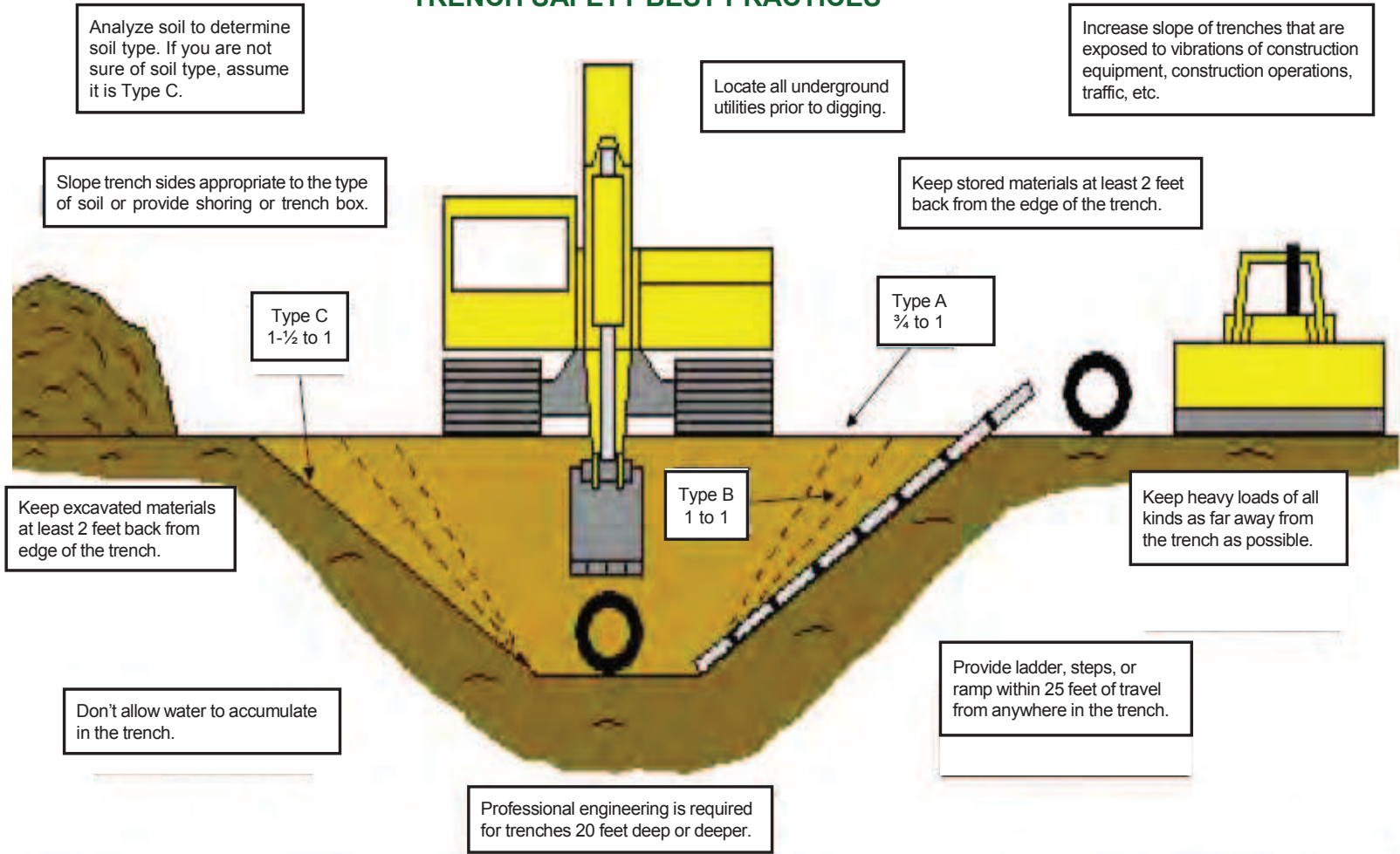

A person of authority, who has completed Trenching Safety Training, must be present at all times while trench work is occurring to inspect for existing or potential hazards and ensure prevention or correction of said hazards. All workers involved with the trench work must also be trained to recognize existing or potential hazards and informed of how to protect themselves from cave-ins.

Section 3	Operation of Motor Vehicles and Equipment	
3.1	Qualifications and Responsibilities	Effective Date: 1/1/2016 Revised: 1/31/2020
3.1.1 Purpose	Operation of motor vehicles and equipment is a core function of the Company's day-to-day operations. This section provides safe work practices regarding the qualifications and responsibilities of employees who operate motor vehicles and equipment.	
3.1.2 Responsibilities	<ol style="list-style-type: none"> 1. The Company is responsible for ensuring employees receive applicable training and are properly qualified to operate vehicles and equipment. 2. Employees shall observe all motor vehicle laws and Company policy. 3. Employees shall use reasonable foresight and care to avoid accidents. 4. Employees shall have full responsibility for vehicles in their possession and will be held accountable for accidents while under their care. 	
3.1.3 Requirements	<ol style="list-style-type: none"> 1. Valid Driver's License 2. Federal Motor Carrier Safety Regulations Booklet 	
3.1.4 Risk Identification	<ol style="list-style-type: none"> 1. Not being qualified and/or trained to operate a particular vehicle or equipment. 2. Unauthorized passengers in violation of the commercial motor vehicles regulations. 3. Driving while impaired and/or distracted. 	
3.1.5 Safe Work Practices	<ol style="list-style-type: none"> 1. Employees shall hold an appropriate classed driver's license before operating a vehicle for Company business. 2. All license restrictions shall be observed. 3. Employees shall observe all Federal, State and local traffic laws and regulations. 4. Seat belts, where provided, shall be worn by the driver and passengers at all times. 5. Employees shall not allow themselves to be distracted while driving. Employees shall not consume food while driving a vehicle on company business. Employees should stop work to eat their meal and to rest. Examples of other activities that can lead to distracted driving are cell phone use, use of other technology, tuning the radio, reaching for items, focused interaction with passengers, sightseeing, etc. 6. Refer to Section 4.1 Cellular Telephone Use for more information on cell phone use while driving. 7. Employees shall always drive in a safe, courteous and defensive manner. Do <u>not</u> drive aggressively. 8. Employees shall not operate a vehicle or equipment while their ability or alertness is impaired or likely to become impaired. 9. Operators of vehicles or equipment other than passenger cars and light trucks shall receive applicable training prior to the operation of such 	

	<p>vehicles or equipment.</p> <p>10. Employees holding a Commercial Driver’s License shall be familiar with and adhere to the Federal Motor Carrier Safety Regulations, 49 CFR Parts 383 and 390.</p> <p>11. For additional information on company vehicles refer to the Company’s Policy “ Use of Company Facilities and Property” http://grid.versantpower.com/pp/Pages/hr_policies.aspx</p>
3.1.6 Definitions	Meal: Typically the food consumed during a planned or unplanned break, normally at least 30 minutes, on regular or overtime hours. See Article XXXI of the union contract for further guidance.

Section 3	Operation of Motor Vehicles and Equipment	
3.2	Pre-Use Inspection and Maintenance	Effective Date: 1/1/2016 Revised: 1/1/2017
3.2.1 Purpose	To ensure employee and public safety, this section provides information on inspection and maintenance of vehicles and equipment.	
3.2.2 Responsibilities	<ol style="list-style-type: none"> 1. The Company is responsible for providing safe and reliable vehicles and equipment. 2. The Company is responsible for providing pre-use inspection training. 3. The employee is responsible for conducting a pre-use inspection of any vehicle or equipment prior to use. 	
3.2.3 Requirements	<ol style="list-style-type: none"> 1. Vehicle Inspection Checklist Form 2. Vehicle and Equipment Maintenance Request Form 3. Emergency Contact Number Reference Card 	
3.2.4 Risk Identification	<ol style="list-style-type: none"> 1. Failure to identify a vehicle or equipment maintenance issue prior to use. 2. Using a vehicle or equipment that is not in safe operating condition. 3. Not having emergency contact numbers in the event the vehicle becomes inoperable. 	
3.2.5 Safe Work Practices	<ol style="list-style-type: none"> 1. Prior to using any vehicle an inspection shall be conducted by completing the Vehicle Inspection Checklist Form. http://grid.versantpower.com/se/Pages/maine_safety.aspx 2. Prior to using any equipment (e.g. snowmobiles or all-terrain vehicles), an inspection shall be performed even if a Vehicle Inspection Checklist Form is not required. 3. Any motor vehicle or equipment found unsafe shall <u>not</u> be operated and shall be tagged out of service. The employee shall report the defect to their supervisor and complete a Vehicle and Equipment Maintenance Request Form. http://intra.versantpower.com/resources/forms/vehicle_inspection.cfm 4. A post-use inspection of CDL vehicles shall be completed at the end of the work day. 5. If the CDL vehicle post-use inspection reveals a defect, the following shall be done: <ol style="list-style-type: none"> a. A DVIR shall be completed and sent to the Fleet Department. b. A copy of the DVIR shall be left in a visible location in the vehicle. 6. An Emergency Contact Number Reference Card shall be available in the vehicle in the event it becomes inoperable. 7. An emergency roadside kit is available in the pool vehicles. 8. All line trucks shall be left in emergency ready condition when they are stored for the night. Emergency ready condition includes: <ol style="list-style-type: none"> a. fuel tank full b. all customary tools, equipment and stock shall be in the truck c. Vehicle is free of all debris & all items are secured. 	

3.2.6 Definitions	CDL: Commercial Driver’s License DVIR: Driver Vehicle Inspection Report is a post-use CDL truck inspection. Pool Vehicle: a vehicle that is not assigned to an employee or department.

Section 3	Operation of Motor Vehicles and Equipment	
3.3	Backing and Parking	Effective Date: 1/1/2016 Revised: 1/1/2018
3.3.1 Purpose	Observing safe backing and parking methods reduces the risks of potential hazards. This section provides safe work practices for employees when backing and parking vehicles.	
3.3.2 Responsibilities	Employees are responsible for following the safe work practices when backing and parking any vehicle or equipment used for company business or on company property or company work sites.	
3.3.3 Requirements	<ol style="list-style-type: none"> 1. Spotter 2. Wheel Chocks, as required 	
3.3.4 Risk Identification	<ol style="list-style-type: none"> 1. Increased potential for injury or property damage when backing or parking. 2. Losing visual contact with the spotter. 	
3.3.5 Safe Work Practices	<ol style="list-style-type: none"> 1. Backing of Vehicles <ol style="list-style-type: none"> a. Employees shall back vehicles into parking spaces when unable to drive through the space. Angled parking that is restricted by traffic flow is excepted from backing. b. Before backing a parked vehicle the employee shall: <ol style="list-style-type: none"> i. Perform a vehicle walk-around inspection and then back-out immediately. ii. Vehicles with unobstructed rear vision <u>should</u> use a spotter if available. iii. Vehicles with obstructed rear vision <u>shall</u> use a spotter if available. iv. If available, use back up camera to assist in backing. c. When spotters are available, they shall guide the operator while standing in a position to the rear of the vehicle and remaining visible to the operator at all times. d. Guidance shall be performed with hand signals, not voice commands. e. The spotter and operator shall coordinate what signals are to be used. f. The operator shall immediately stop when the spotter is not visible to them. g. Alone or guided, the operator shall back-up slowly and cautiously. 2. Parking <ol style="list-style-type: none"> a. Whenever possible, employees shall park so that they can drive out of the space when leaving. b. All laws and ordinances regarding parking shall be strictly 	

	<p>observed.</p> <ul style="list-style-type: none"> c. Vehicles shall be parked in designated parking spaces when available. d. Employees shall drive cautiously while in parking lots. e. Vehicles shall always be parked so that others may pass safely. f. Employees should avoid parking on bridges, culverts, blind curves, hillcrests or narrow places in the road. g. Class A and B vehicles are required to place wheel chocks on the rear wheels of the vehicle under the following conditions: <ul style="list-style-type: none"> i. Whenever the vehicle is parked and there is a risk of the truck moving due to incline or slippery conditions. Parking in a garage is exempt from this requirement. ii. Whenever the boom or bucket is in the air, including when the vehicle is set on level ground. This also applies to class C squirt boom trucks. h. To the extent possible, vehicles should be parked on the same side of the road where work is being performed. i. When it is necessary for a vehicle to park facing traffic, headlights shall be turned off. j. If vehicle is not equipped with a strobe light, four-way flashers shall be turned on when parked roadside. k. Company vehicles should not be stopped or parked opposite one another, unless work dictates and traffic control is in place.
<p>3.3.6 Definitions</p>	<p>Class A Vehicle: any combination of vehicles which has a gross combination weight rating or gross combination weight of 26,001 pounds or more, inclusive of a towed unit with a gross vehicle weight rating or gross vehicle weight of more than 10,000 pounds.</p> <p>Class B Vehicle: any single vehicle which has a gross vehicle weight rating or gross vehicle weight of 26,001 pounds or more, or any such vehicle towing a vehicle with a gross vehicle weight rating or gross vehicle weight that does not exceed 10,000 pounds.</p> <p>Obstructed Rear Vision: any vehicle that does not have clear vision from the driver's position through the rear window to the rear of the vehicle. Vehicles identified as having obstructed vision to the rear include, but are not limited to: bucket trucks, digger trucks, derrick trucks, vans, box trucks, flatbed trucks, stock trucks, pickups with bed caps, and any other vehicle that the operator must use the outside mirrors as the primary vision aid for backing.</p> <p>Spotter: a person who is responsible to watch for and guide another person away from potential dangers.</p> <p>Unobstructed Rear Vision: any vehicle that has clear vision from the driver's position through the rear window to the rear of the vehicle.</p>

Section 3	Operation of Motor Vehicles and Equipment	
3.4	Operating in Traffic	Effective Date: 1/1/2016 Revised:
3.4.1 Purpose	To ensure that employees who drive vehicles in the course of their work demonstrate safe driving behavior at all times. To ensure that work zones are constructed in a safe manner.	
3.4.2 Responsibilities	<ol style="list-style-type: none"> 1. The Company shall provide training on the appropriate MUTCD regulations. 2. The Company shall provide adequate resources for work zone protection and traffic control. 3. Employees shall obey all traffic laws, rules and regulations. 4. Employees shall exhibit courtesy while driving. 5. Employees shall be aware of and adjust to operating conditions as needed. 6. Employees required to construct work zones shall be familiar with the applicable MUTCD regulations. 7. Employees shall establish and maintain safe and efficient work zones. 	
3.4.3 Requirements	<ol style="list-style-type: none"> 1. Valid Driver’s License 2. Traffic control personnel or devices 3. Safety signal for oversized loads 4. Permitting 5. MUTCD, as provided by the Safety Department 	
3.4.4 Risk Identification	<ol style="list-style-type: none"> 1. Traffic accidents resulting in bodily injury or property damage. 2. Company and employee liability as a result of traffic accidents. 3. Moving traffic around work zones. 4. Public safety around work zones. 	
3.4.5 Safe Work Practices	<ol style="list-style-type: none"> 1. General <ol style="list-style-type: none"> a. Employees shall observe all traffic laws, rules and regulations including: <ol style="list-style-type: none"> i. Posted school zone speed limits ii. Stopping for school buses with flashing lights iii. Yielding to emergency vehicles iv. Yielding to pedestrians v. Keeping the correct distance from bicycles vi. Coming to a complete stop at “Stop” signs vii. Using turn signals viii. Wearing seat belts at all times, where provided b. Employees shall always practice courtesy toward other drivers and pedestrians. c. When turning, employees shall ensure that the vehicle is correctly positioned and that there is adequate clearance for 	

	<p>turning.</p> <ul style="list-style-type: none"> d. Employees shall use caution when approaching railroad crossings and shall ensure that no trains are approaching before crossing railroad tracks. e. Before passing another vehicle, employees shall have unobstructed forward vision and adequate space. f. Maintain a safe driving distance while following vehicles. Observe the “three second rule” unless conditions warrant greater following distance. g. When vision is limited, employees shall reduce their speed to allow for safe stopping distance. h. Follow the vehicle manufacturer’s guidelines when braking in slippery/wet conditions. i. Any material that projects more than four feet beyond the rear of the vehicle body must have a red or orange flag hung by day and a reflective flag, approved reflector or warning light by night. j. Vehicles shall not exceed the legal width, height or weight on the highway without proper permitting. <p>2. Work Zone Protection – Traffic Control</p> <ul style="list-style-type: none"> a. There are many operations that require control or restriction of traffic. Procedures for controlling traffic are covered in detail in the most current version of the MUTCD. b. Employees required to set up traffic control for work zone protection shall be familiar with the applicable MUTCD requirements. c. Refer to Section 3.4 Attachment A for common work zone setups.
<p>3.4.6 Definitions</p>	<p>MUTCD: Manual on Uniform Traffic Control Devices</p>

Versant Power Traffic Control Protocols

As required by:

U.S. DOT Manual on Uniform Traffic Control Devices

Maine DOT Utility Accommodation Rules

17-229 CMR Chapter 210

Occupational Safety & Health Administration

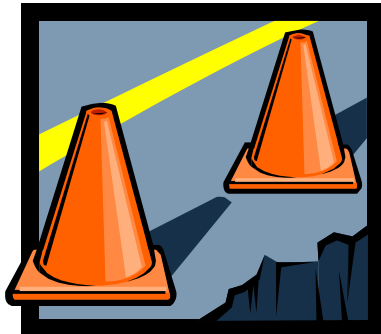

1. Hazards associated with traffic control place utility workers at considerable risk. After discussing traffic hazards during the crew's tailboard conference, the lead worker shall develop a work zone traffic control plan to account for these hazards. When traffic control contractors are used, the contractors must be part of the tailboard conference discussion.
2. The lead worker must consider the following factors when developing a traffic control plan:
 - a. traffic speed
 - b. traffic density
 - c. driver's sight-distance
 - d. length of work-duration:
 - Mobile - work that moves intermittently or continuously with frequent short stops.
 - Short-duration – occupies a location up to 1 hour.
 - Short-term – occupies a location more than 1 hour, but less than 12 hours.
 - e. width and type of roadway
 - f. time of day
 - g. weather
3. All traffic control devices shall be installed at the work site before work begins and be properly maintained throughout the duration of the work. They shall also be removed immediately when no longer needed.
4. Lead Workers are responsible for insuring that all traffic control elements are effective in providing safe conditions for motorists, pedestrians and workers.
5. Motorists should be guided in a clear and positive manner while approaching and traversing a utility work area.
6. Adequate warning, delineation and channelization by means of signing, coning and other devices which are effective under varying conditions of light and weather shall be provided.
7. Frequent and abrupt changes such as lane narrowing, dropped lanes, or main roadway transitions which require rapid maneuvers, should be avoided.
8. Flagging Stations
 - a. Stations shall be far enough in advance of work areas to be clearly visible in order that drivers may have time to observe and react.
 - b. Adequate advance warning by using 'Utility Work Ahead', 'Flagger Ahead', and 'One Lane Road Ahead' signs shall always precede a flag person's station.

- c. At night, flag person's station shall be illuminated.
- d. Flag persons should stand either on the shoulder adjacent to the traffic being controlled, or where there is no shoulder, at the outer edge of the pavement on roadway.

CAUTION - Flag persons must never stand in a lane being used by traffic.

9. Communication Between Flaggers

- 10. Regardless of the method of communication used, whenever more than one flag person is stationed at a work area, one person must be appointed as “chief” to coordinate traffic movement. If two flaggers are used, two-way radios shall be used to communicate between flaggers.

Work Zone Traffic Control Diagram Legend

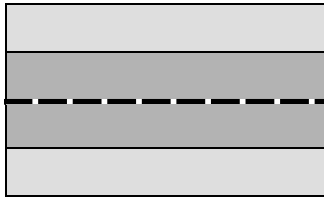

**Represents Travel Lanes and
Shoulders**



Work Vehicle



Work Area

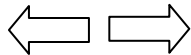

Direction of Traffic Flow



Road Cones



Flagger



Flagger Requirements



Clothing:

Traffic Control High Visibility Vest
Hardhat
Gloves
Footwear
Safety Glasses

Flagger Equipment:

Stop/Slow Paddle with Staff
Emergency Red Flag
Light Wand
Reflective Road Cones
Two-Way Radios

Who and What the flagger protects:

Yourself, Crew, Motorists or Pedestrian travelling Through Work Zone, and equipment.

To be a good flagger you should be:

Mentally alert, in good physical condition, and authoritative.

The “Don’ts” of flagging:

Mingle with the crew, leave your post, turn your back to traffic, sit down on the job, use a cell phone.

Tables and References

Table 2 - Sign Spacing

TABLE 1 BUFFER SPACE	
Speed (mph)	Distance (ft)
20	115
25	155
30	200
35	250
40	305
45	360
50	425
55	495
60	570
65	645
70	730
75	820

<u>Road Type</u>	<u>Sign Spacing</u>
Urban-Low Speed	100'
Urban - High Speed	350'
Rural	500'
Interstate Highway	1,000'

<u>TABLE 3 MAX DISTANCE BETWEEN CONES</u>		
SPEED (MPH)	TAPER AREA(FT)	BUFFER OR WORK AREA(FT)
20	20	40
25	25	50
30	30	60
35	35	70
40	40	80
45	45	90
50	50	100
55	55	110
60	60	120
65	65	130
70	70	140
75	75	150

Work Zone 1

Work Beyond the Shoulder

For short-term, short duration, or mobile operation, all signs and channelizing devices may be eliminated if the work area is in front of the vehicle and a vehicle with an active flashing or revolving light is used.

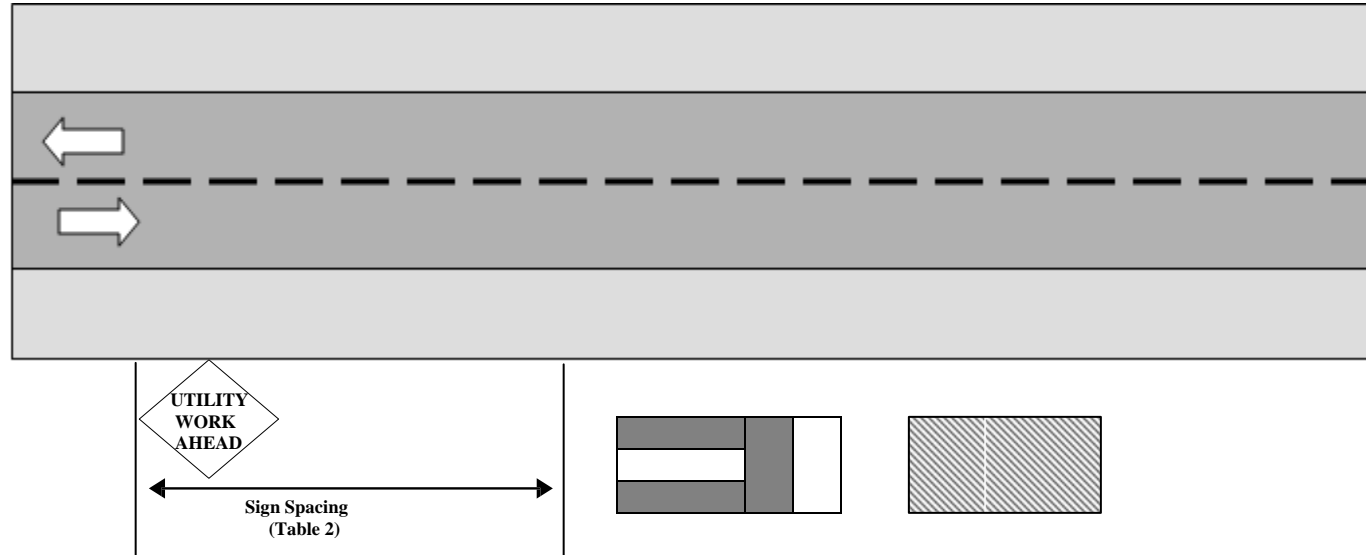

NOTE: SEE TABLE 3 FOR CONE SPACING

Utility Work Ahead sign not required if the work space is behind a barrier, more than 2 feet behind the curb, or 15 feet or more from the edge of any roadway.

Work Zone 2 Work on the Shoulder

For short duration, all channelizing devices may be eliminated if the work area is in front of the vehicle and a vehicle with an active flashing or revolving light is used.

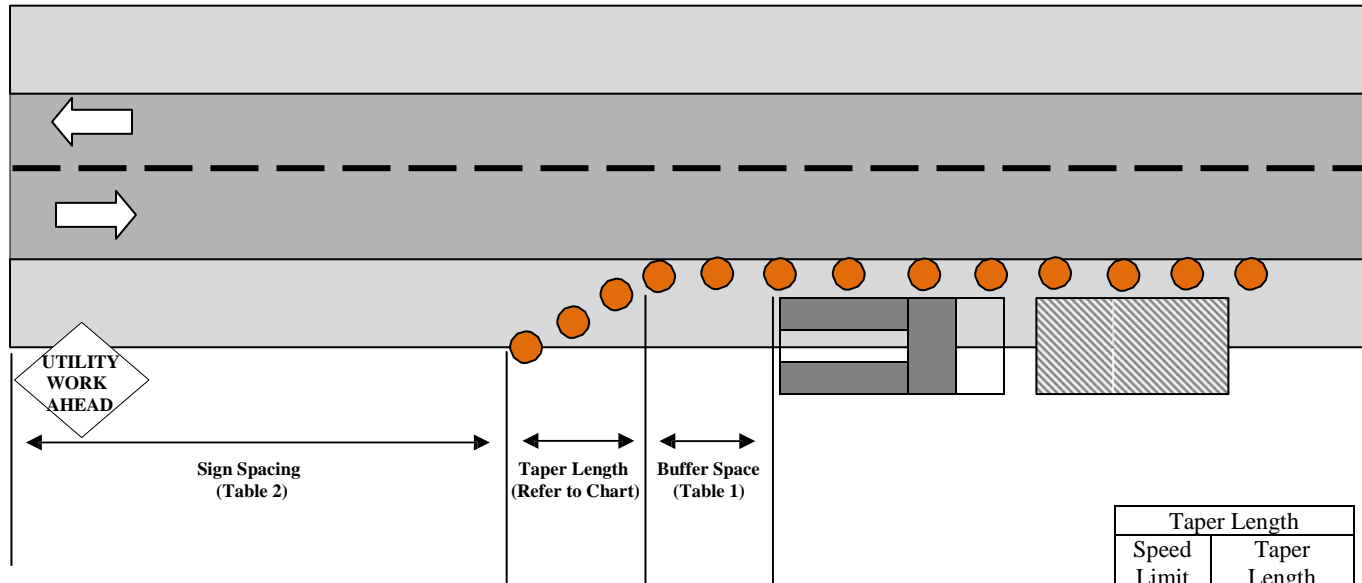

Taper Length	
Speed Limit (mph)	Taper Length (feet)
25	35
30	50
35	70
40	90
45	150
50	170
55	190

Note: High Visibility clothing such as approved vests, rain gear, etc. must be worn whenever crews are in the roadway or on the shoulder.

NOTE: SEE TABLE 3 FOR CONE SPACING

Work Zone 3 Work on the Shoulder, Two Trucks With Pole on Pole Trailer

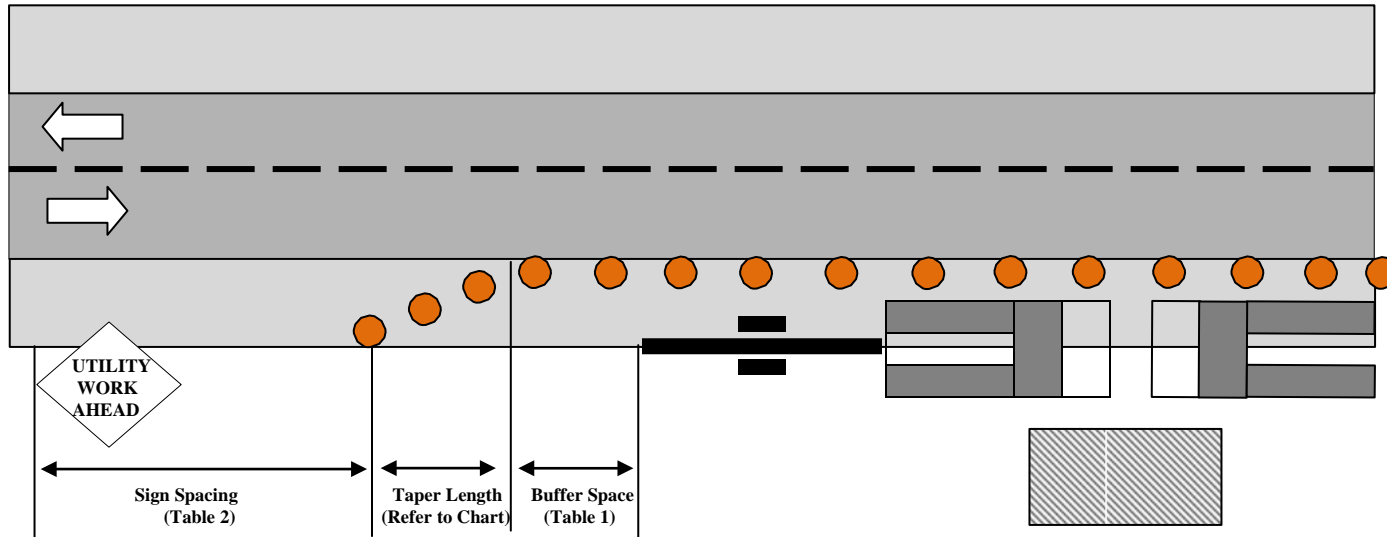

Taper Length	
Speed Limit (mph)	Taper Length (feet)
25	35
30	50
35	70
40	90
45	150
50	170
55	190

An active flashing or revolving light is required on both vehicles.

Note: High Visibility clothing such as approved vests, rain gear, etc. must be worn whenever crews are in the roadway or on the shoulder.

NOTE: SEE TABLE 3 FOR CONE SPACING

Work Zone 4

Lane Closure, Urban Street, Self Regulating Traffic Flow

The traffic procedure shown is appropriate for low-volume, low-speed residential streets.

Traffic can regulate itself when volumes are low and the length of work space is short, if drivers can easily see the road beyond.

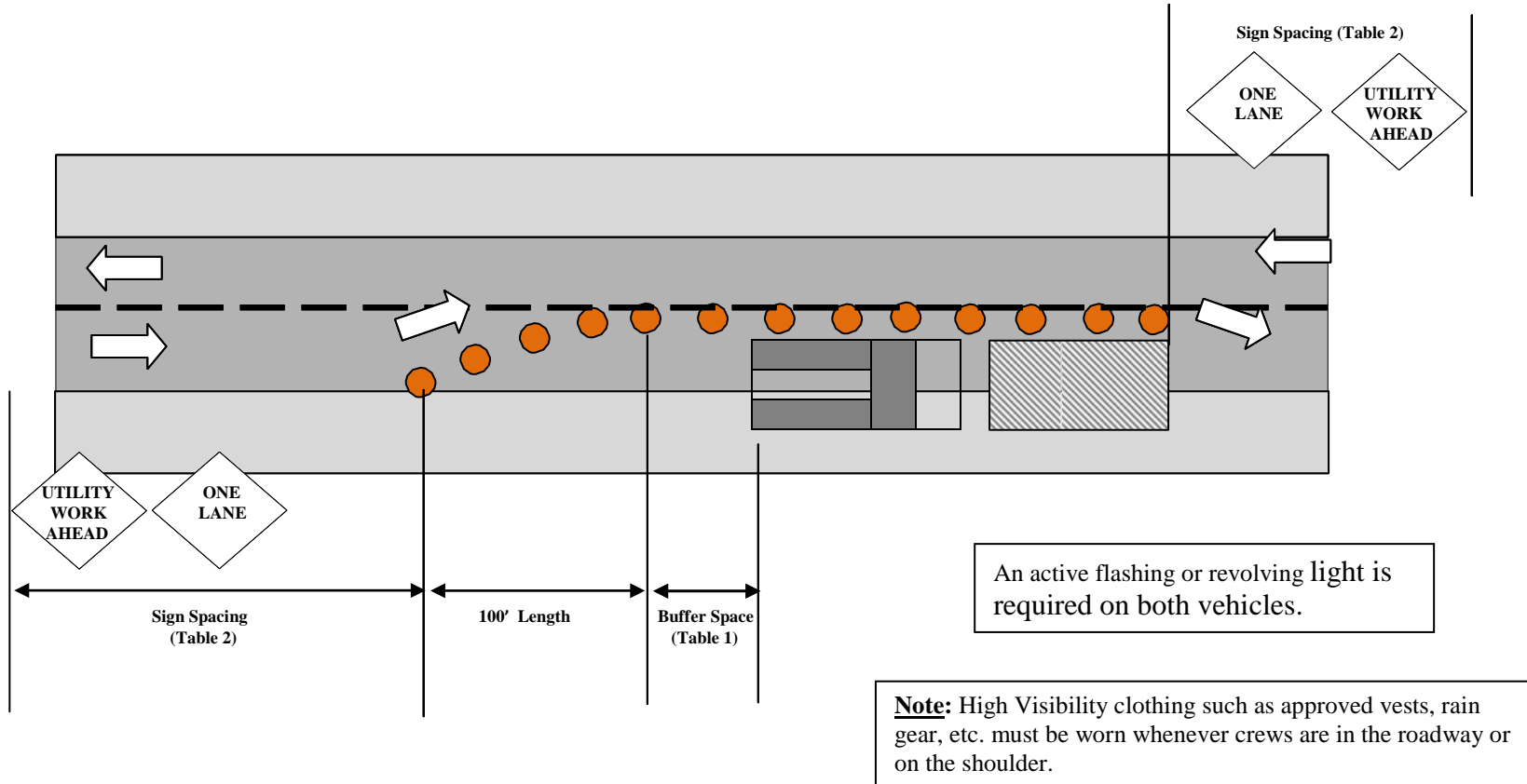

NOTE: SEE TABLE 3 FOR CONE SPACING

Work Zone 5

Lane Closure, Urban Street, Single Flagger Control

The traffic procedure shown is appropriate for low-volume, low-speed residential streets where traffic cannot regulate itself due to visibility, conditions, volume, etc.

A single flagger can regulate traffic when volumes are low and the length of the workspace is short, if the drivers can easily see the flagger from either direction.

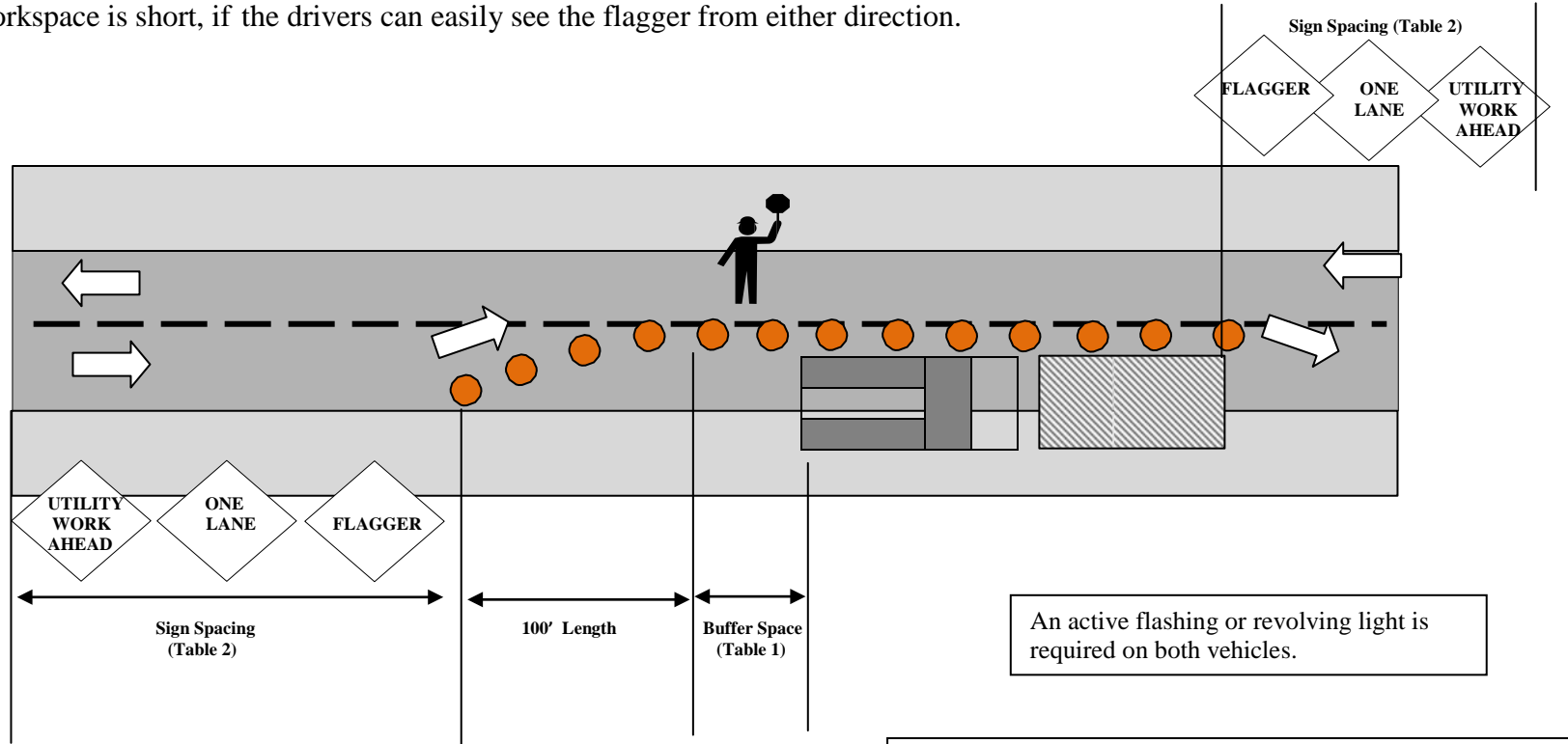

Note: High Visibility clothing such as approved vests, rain gear, etc. must be worn whenever crews are in the roadway or on the shoulder.

NOTE: SEE TABLE 3 FOR CONE SPACING

Work Zone 6

Lane Closure, Urban Street, Single Flagger Control, Two Trucks Back to Back

The traffic procedure shown is appropriate for low-volume, low-speed residential streets where traffic cannot regulate itself due to visibility, conditions, volume, etc.

A single flagger can regulate traffic when volumes are low and the length of the workspace is short, if the drivers can easily see the flagger from either direction.

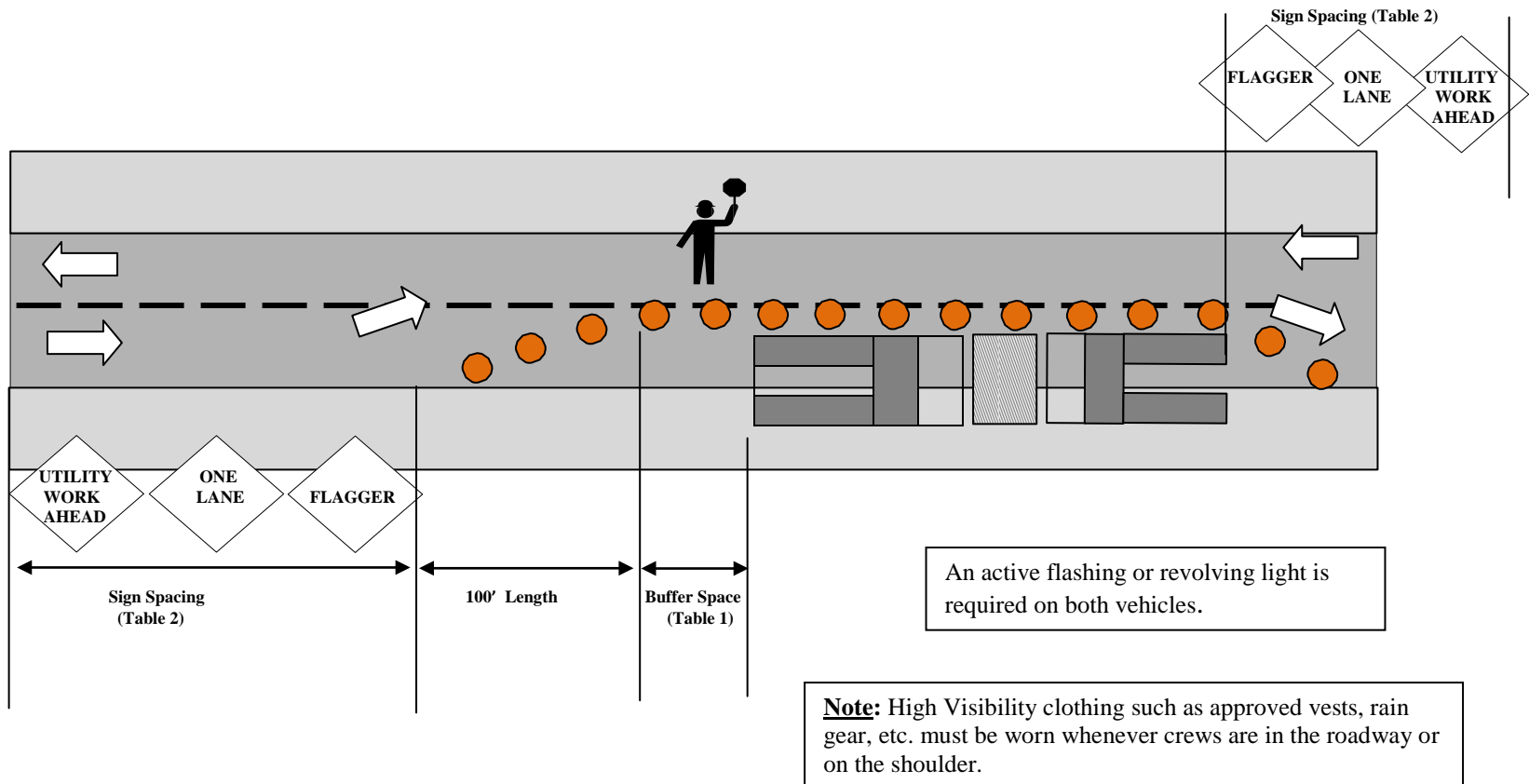

NOTE: SEE TABLE 3 FOR CONE SPACING

Work Zone 7 Lane Closure, Two-Lane Road, Flagger Control

If the work area is just around a curve in the road, position the flagger before the curve and extend the channelizing devices to where they can be seen by approaching traffic.

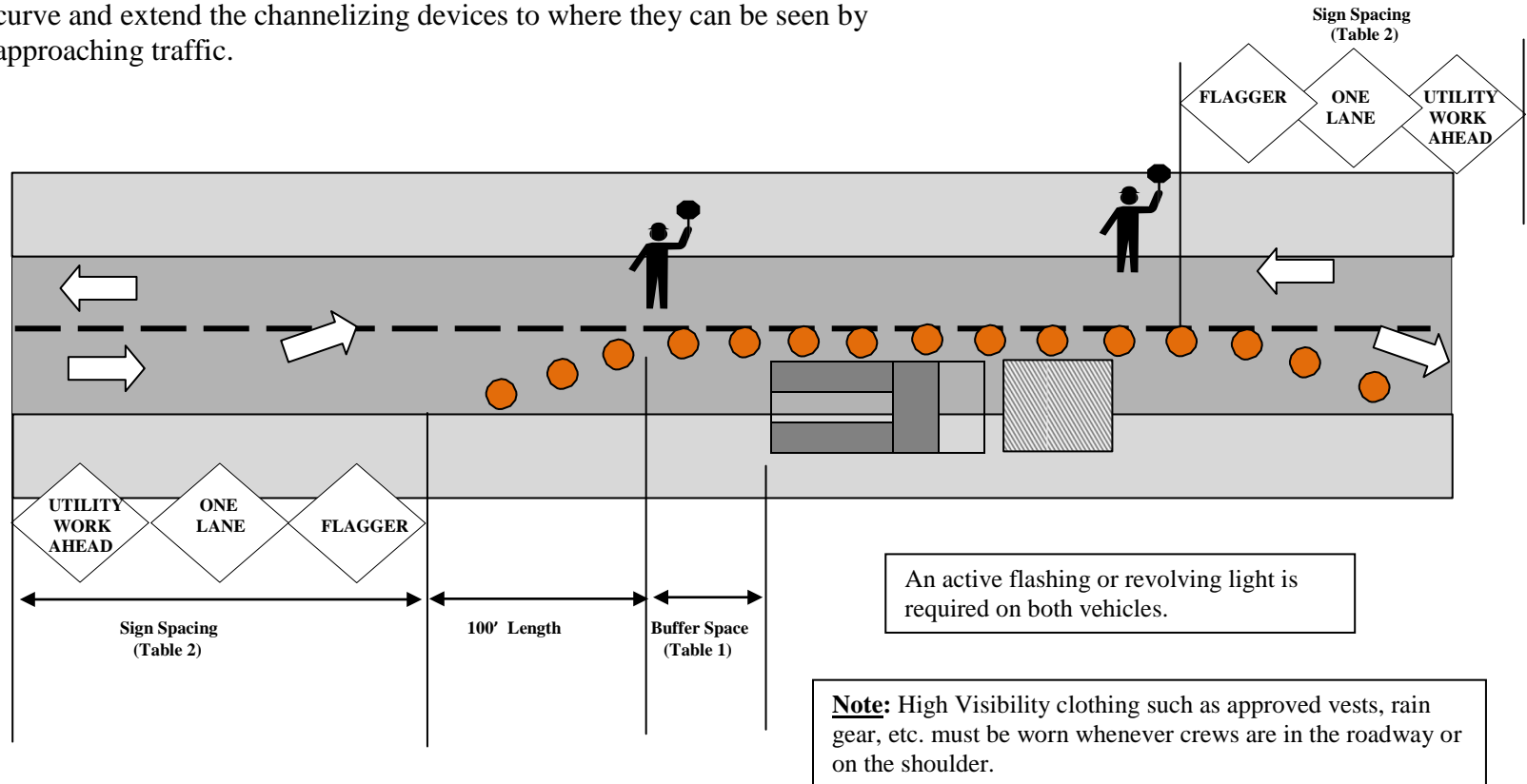

NOTE: SEE TABLE 3 FOR CONE SPACING

Work Zone 8 Lane Closure Near Intersection

If work extends across the crosswalks, the crosswalks must be closed.

The merging taper may direct traffic to either the left lane or right lane but not both. In this case a left taper should be used so that right turn movements will not impede traffic.

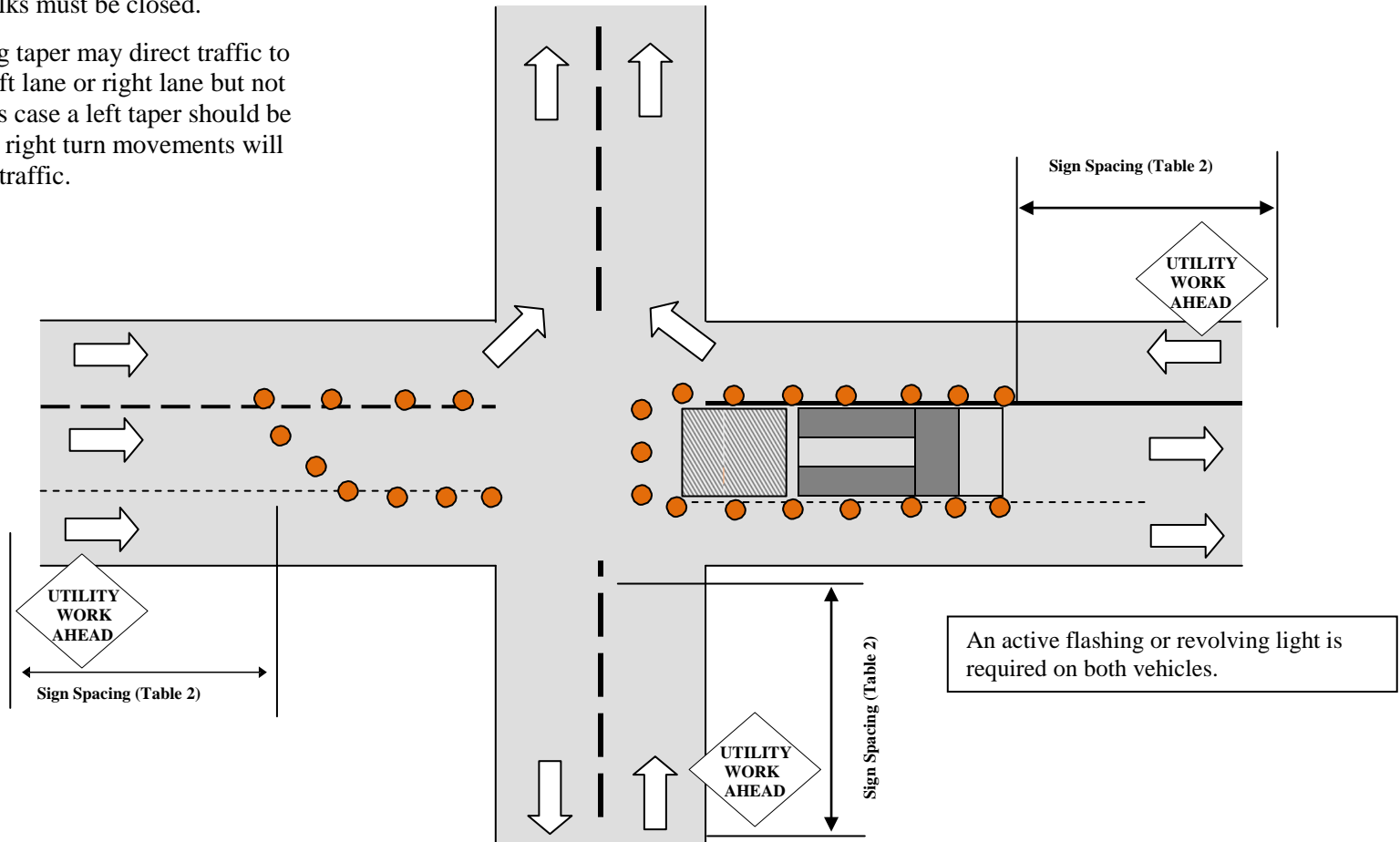

Note: High Visibility clothing such as approved vests, rain gear, etc. must be worn whenever crews are in the roadway or on the shoulder.

NOTE: SEE TABLE 3 FOR CONE SPACING

NOTE: SEE TABLE 3 FOR CONE SPACING

Work Zone 9 Lane Closure Corner of Intersection

If work extends across the crosswalks, the crosswalks must be closed.

For low traffic volume and intersecting 2 landed streets, one flagger positioned in the center of the intersection may suffice.

For high traffic, or 4 lane streets, additional flaggers or law enforcement may be needed

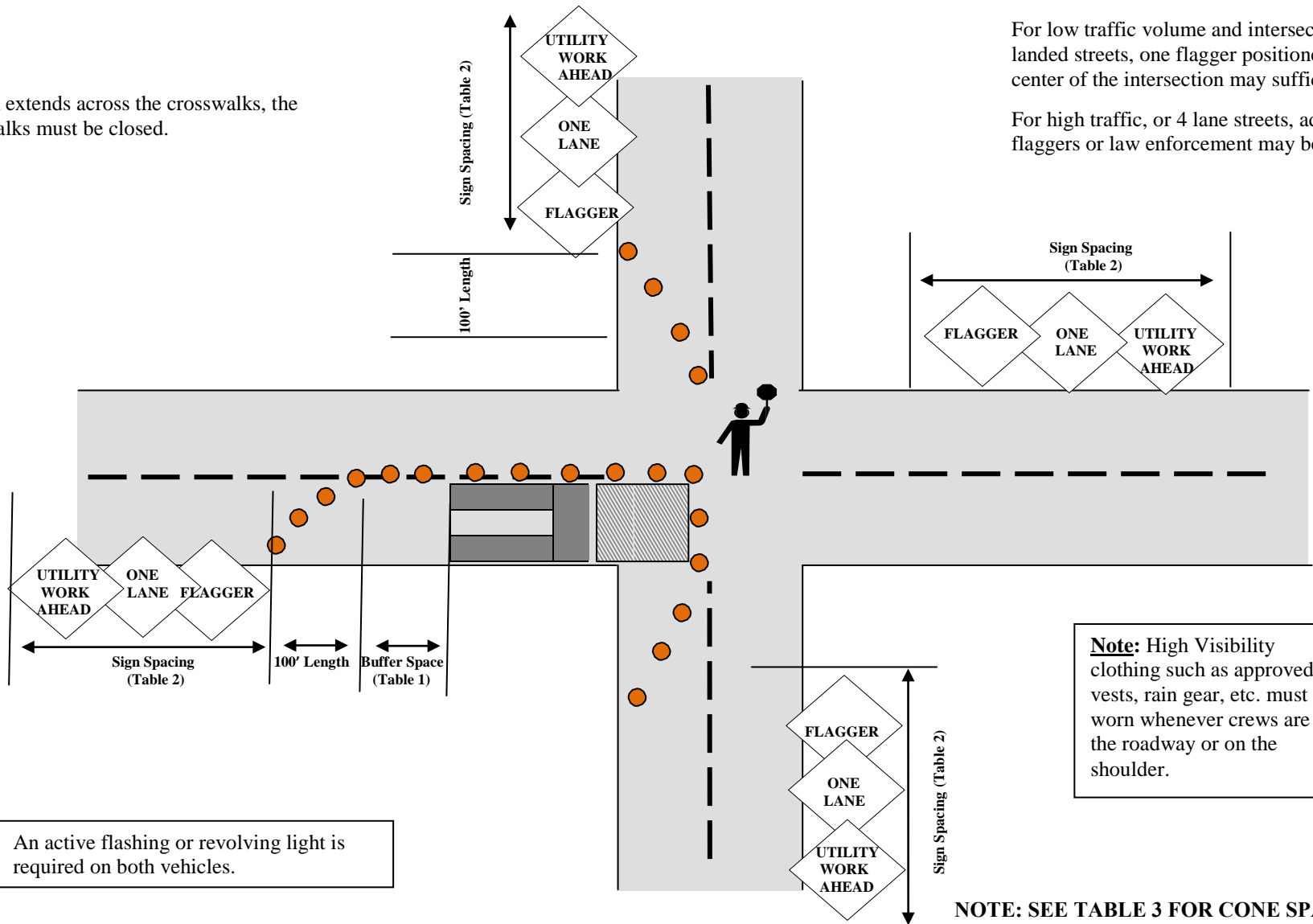

An active flashing or revolving light is required on both vehicles.

Note: High Visibility clothing such as approved vests, rain gear, etc. must be worn whenever crews are in the roadway or on the shoulder.

NOTE: SEE TABLE 3 FOR CONE SPACING

Work Zone 10

Lane Closure, Two-lane Road, On A Curve, Flagger Control

If the work area is just around a curve in the road, position the flagger before the curve and extend the channelizing devices to where they can be seen by approaching traffic.

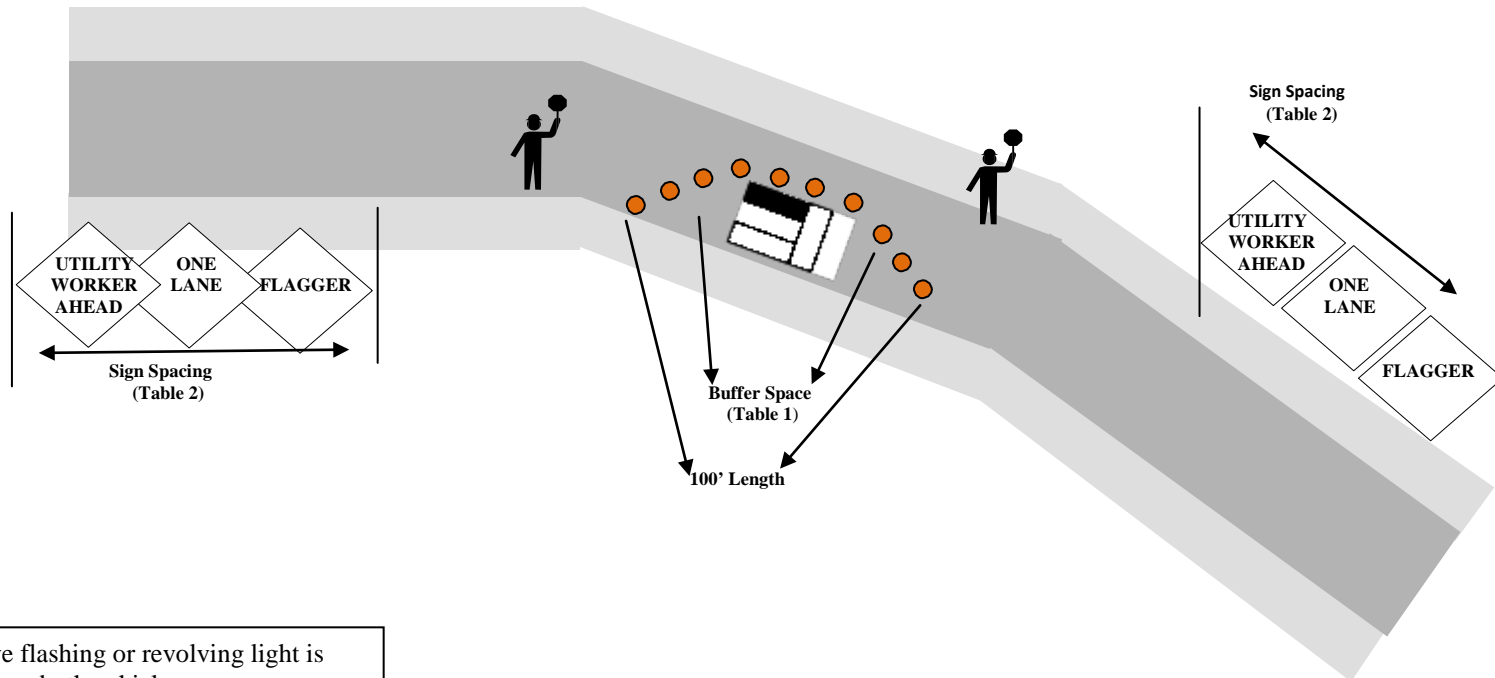

An active flashing or revolving light is required on both vehicles.

Note: High Visibility clothing such as approved vests, rain gear, etc. must be worn whenever crews are in the roadway or on the shoulder.

NOTE: SEE TABLE 3 FOR CONE SPACING

Section 3	Operation of Motor Vehicles and Equipment	
3.5	Insulated Aerial Lift	Effective Date: 1/1/2016 Revised: 1/31/2020
3.5.1 Purpose	The insulated aerial lift (“lift”) is an essential tool for maintaining the Company’s transmission and distribution system. This section provides employees with information and safe work practices when operating insulated aerial lifts.	
3.5.2 Responsibilities	<ol style="list-style-type: none"> 1. The Company is responsible for providing and maintaining lifts. 2. The Company is responsible for providing training on the safe operation of lifts. 3. The employee is responsible for operating and maintaining the equipment in accordance with the manufacturer’s guidelines and Company safe work practices. 4. Employees whose job requirements include working out of a bucket truck must perform Bucket Rescue and Self Rescue drills per company procedures annually. 	
3.5.3 Requirements	<ol style="list-style-type: none"> 1. Valid Driver’s License 2. PPE 3. Required maintenance including dielectric test 4. Proper qualifications 5. Operator’s Manual 	
3.5.4 Risk Identification	<ol style="list-style-type: none"> 1. Personal injury or property damage caused by equipment failure. 2. Improper operation of Lift resulting in equipment and property damage or personal injury. 3. Traffic accidents resulting in bodily injury or property damage. 4. Serious injury caused by electrical contact. 5. High pressure hydraulic oil hoses failing. 6. Inclement weather including wind while working aloft 	
3.5.5 Safe Work Practices	<ol style="list-style-type: none"> 1. General <ol style="list-style-type: none"> a. The truck, boom or aerial bucket shall not be solely depended upon for electrical insulation. b. A pre-use inspection as required in Section 3.2 Pre-Use Inspection and Maintenance shall be performed before use. Specifically, the following shall be inspected: <ol style="list-style-type: none"> i. Boom ii. Bucket iii. Bucket Liner iv. Controls v. Hydraulic system c. A post trip inspection as required in Section 3.2 Pre-Use Inspection and Maintenance shall be performed after use. 	

- d. If a problem is found with the equipment, the operator shall report the defect by completing a Vehicle and Equipment Maintenance Request Form.
http://intra.versantpower.com/resources/forms/vehicle_inspection.cfm
- e. Before daily use, the operator shall operate the empty bucket from the lower controls.
- f. Operators manual shall be located in the vehicle. If the manual is missing, contact the Fleet Department for replacement.
- g. The operator shall observe the manufacturer's operating guidelines.
- h. Approved fall protection shall be worn at all times while in the bucket. Refer to **Section 2.10 Fall Protection** for information on fall protection.
- i. All workers should be aware of the risk for hydraulic oil leaks. The pressurized hydraulic system is a significant hazard.
- j. No portion of the lift equipment shall be altered in any manner unless approved by the manufacturer.
- k. Material handlers shall be operated according to the manufacturer's guidelines.
- l. Any attachments to the bucket shall be approved by the manufacturer.
- m. Gaffs shall not be worn while performing work from any lift equipment.

2. Work Zone Protection

- a. Lift equipment shall not be grounded when an employee is in the bucket.
- b. Death or serious injury will result from contact with load, unit, vehicle, or vehicle attachment if any part of the unit becomes energized. All employees shall understand and follow safe electrical work practices. If any part of the unit is elevated within the minimum approach distance of an energized conductor, all unauthorized personnel shall keep clear.
- c. The truck shall be set up so the job can be accomplished in the safest and most efficient manner.
- d. Actions to ensure that the public is protected from the work zone include, but are not limited to:
 - i. Only those permitted in the work zone are allowed to be near the truck.
 - ii. Use "WARNING" signs and road cones.
 - iii. Reasonable effort to guard the public from work zone hazards.
- e. Refer to **Section 3.4 Operating in Traffic** for additional work zone safety practices.

3. Travel Practices

- a. Employees may ride in the bucket for short moves at the work

location if the bucket is returned to the cradled position for each move.

- b. Employees shall not ride in the bucket in right-of-ways or over rough terrain, or while the truck is traveling between work locations.
- c. Do not move the truck if the lift cannot be returned to a cradled position, unless maneuvering for positioning or cleaning the truck.
- d. The jib shall be properly retracted during transportation.

4. Working Aloft

- a. Careful consideration shall be given to the location of overhead conductors and the surrounding conditions before the truck is moved into the work position.
- b. The truck shall be set up so the angle indicator is within the manufacturer's required specifications.
- c. Ground workers shall be aware of the bucket position at all times. Working directly under the bucket should be avoided.
- d. Footing for the truck wheels and/or outriggers shall be examined carefully and extra precaution taken if there is snow, ice, mud or soft ground.
- e. The employee shall ensure the outriggers or jacks are in the down position, the parking brake is set and wheel chocks are set before operating the lift.
- f. Extra precautions shall be taken when the lift is maneuvered over a street, sidewalk, or highway.
- g. Entering the bucket should be done from the normal cradled position or with the bucket resting close to the ground.
- h. When situations require an employee to exit the bucket while uncradled, the employee shall maintain 100% tie off during the transfer.
- i. When the bucket is occupied, the lower controls shall only be used in the event of an emergency.
- j. The employee shall note the location of all obstructions that may interfere with operation of the boom.
- k. The employee shall stand firmly in the bucket. No devices for additional reach or height shall be permitted unless approved.
- l. Employees shall not throw or drop tools to or from the bucket.
- m. Employees shall not drop materials from the bucket unless the area below has been cleared of all persons and traffic.
- n. A bucket self-rescue device shall be available for use at all times. If working alone, the device shall be with the employee in the bucket.
- o. While working in the squirt boom truck, the upper boom shall be extended past the red arrows before being considered insulated.
- p. Attention should be paid to weather conditions especially winds that could lead to movement & possible contact.

	<p>5. Testing and Maintenance</p> <ul style="list-style-type: none"> a. All aerial lift equipment shall be dielectrically tested annually, at a minimum. b. Any new or leased equipment shall be dielectrically tested by the Company prior to being put into service. c. Additional dielectric testing will be done after the following has occurred: <ul style="list-style-type: none"> i. The installation of new hydraulic hoses ii. Clean-up from a hose leak or rupture in the boom iii. Any boom damage iv. Welding operations in the vicinity of the boom. v. Known electric contact by the boom that causes an arc flash. d. Employees performing the dielectric tests shall observe the following: <ul style="list-style-type: none"> i. The testing area shall be at least ten feet away from any building or structure. ii. The testing area shall be roped off and only testing personnel and truck operator will be permitted inside the testing area. iii. All testing shall be done in accordance with OSHA standard, 1910.269(o). e. Any lift equipment failing the test shall be tagged out of service until repaired or cleaned sufficiently to pass the testing procedure. f. The boom and bucket shall be inspected for cleanliness as part of the pre-use inspection. Booms shall be cleaned with approved products as needed, at a minimum of once a month. g. Lift equipment shall be reported to the Fleet Department for inspection if any of the following occurs: <ul style="list-style-type: none"> i. Contact with energized conductors causing an arc flash. ii. Any boom damage or boom contact outside of normal operation.
<p>3.5.6 Definitions</p>	<p>Dielectric: insulating material or a very poor conductor of electric current.</p> <p>Material Handler: a device also known as a jib which is attached to an aerial lift and is used to hoist moderately sized materials and equipment.</p> <p>Squirt Boom Truck: a small articulating telescoping material device with a boom length of 42' or less.</p>

Section 3	Operation of Motor Vehicles and Equipment	
3.6	Digger-Derricks	Effective Date: 1/1/2016 Revised: 1/1/2018
3.6.1 Purpose	This section provides employees with information and safe work practices when operating digger-derricks.	
3.6.2 Responsibilities	<ol style="list-style-type: none"> 1. The Company shall provide adequate training on the use of digger-derricks. 2. The Company shall provide and maintain digger-derricks for safe operation. 3. Employees shall follow the manufacturer’s recommendations on digger-derrick operation. 4. Employees shall use proper rigging techniques when moving loads. 5. Employees shall know and use proper signaling. 	
3.6.3 Requirements	<ol style="list-style-type: none"> 1. Valid Driver’s License 2. Grounding equipment 3. Slings and lifting devices 4. PPE 5. Dig Safe Ticket 	
3.6.4 Risk Identification	<ol style="list-style-type: none"> 1. Personal injury or property damage caused by equipment failure. 2. Improper operation of the boom resulting in equipment and property damage or personal injury. 3. Traffic accidents resulting in bodily injury or property damage. 4. Serious injury caused by electrical contact. 5. High pressure hydraulic oil hoses failing. 6. Rollover during transportation or operation. 7. Hitting/damaging underground utilities. 	
3.6.5 Safe Work Practices	<ol style="list-style-type: none"> 1. General <ol style="list-style-type: none"> a. A pre-use inspection as required in Section 3.2 Pre-Use Inspection and Maintenance shall be performed before use. Specifically, the following shall be inspected: <ol style="list-style-type: none"> i. Boom ii. Sheaves iii. Hoses iv. Hydraulic system v. Auger wind-up rope vi. Controls b. Winch lines shall be inspected before use. Defective winch lines shall be replaced and a Vehicle and Equipment Maintenance Request Form submitted. c. Only employees necessary for the work shall be under or near the digger-derrick during its operation. Always be aware of the digger-derrick location. d. The upper boom provides electrical insulation and shall be extended before the digger-derrick is considered insulated. e. Trucks shall be effectively grounded when there is danger of coming in contact with energized lines or when induced voltage is present. Refer to Section 5.5 Protective Grounding. 	

	<ul style="list-style-type: none"> f. All personnel should be aware of the risk for hydraulic oil leaks. The pressurized hydraulic system is a significant hazard. g. The digger-derrick truck is top heavy. Employees shall be aware of its stability during transportation and while lifting heavy objects. h. Any cargo in the back of a truck shall be contained, immobilized or secured during transportation. i. Death or serious injury will result from contact with load, unit, vehicle or vehicle attachment if any part of the unit becomes energized. All employees shall understand and follow safe electrical work practices. If any part of the unit is elevated within the minimum approach distance of an energized conductor, all unauthorized personnel shall <u>keep clear</u>. <p>2. Operation</p> <ul style="list-style-type: none"> a. Employees shall ensure the outriggers or jacks are in the down position, the parking brake is set and wheel chocks are set before operating the boom. b. Load capacity charts shall be strictly observed. c. Operation of the digger-derrick shall be done from the elevated platform or seat, unless a wireless remote is used. d. A crane, digger-derrick, or other equipment that allows the operator to stand or sit on the machine without making contact with ground, or any other difference in potential, can be considered an equal potential zone. Rubber gloves are not required to be worn by the operator in this environment, as it offers the operator no additional protection. e. Cover-up shall be used where the digger-derrick or load are in the mad zone or may come into contact with energized primary conductors. f. The employee should remain at the controls while there is a suspended load. g. The employee shall use extreme caution when lowering/releasing the auger. h. Spotter should provide guidance with approved hand signals, not voice commands. i. Monitor the winch line for potential hazards when lifting a load with the digger-derrick. j. Digger Tongs are guides and not to be used for lifting or dragging poles. k. Employees shall not perform side loading with the digger-derrick. l. Pulling poles out of the ground with the digger-derrick is not permitted <u>unless</u> the pole has been loosened with a pole jack or other means.
<p>3.6.6 Definitions</p>	<p>Digger-Derrick: a specialized type of equipment equipped with augers to drill holes and with a hydraulic boom to lift, designed to install utility poles. A digger derrick does not fall under OSHA crane rules 1926.1400 when used for poles & materials associated with power transmission & distribution work.</p> <p>Outriggers: a projecting frame which extends from the vehicle as a means of stabilizing the vehicle during operation.</p>

Section 3	Operation of Motor Vehicles and Equipment	
3.7	Uninsulated Aerial Lift	Effective Date: 1/1/2016 Revised:
3.7.1 Purpose	To aid in the safe operation of uninsulated aerial lifts (“lift”), this section provides employees with the safe work practices when using this equipment.	
3.7.2 Responsibilities	<ol style="list-style-type: none"> 1. The Company shall provide the appropriate equipment for the work. 2. The employee shall be familiar with the operation of the lift to be used. 	
3.7.3 Requirements	<ol style="list-style-type: none"> 1. Fall Protection 2. Grounding, if required 3. PPE 	
3.7.4 Risk Identification	<ol style="list-style-type: none"> 1. Personal injury caused by occupants or objects falling from the lift. 2. Personal injury or property damage caused by equipment failure. 3. Improper operation of lift resulting in equipment and property damage or personal injury. 4. Serious injury caused by electrical contact. 5. Roll over hazards caused by ground conditions or terrain. 	
3.7.5 Safe Work Practices	<ol style="list-style-type: none"> 1. A pre-use inspection shall be completed on the lift per the manufacturer’s recommendations. 2. The lift shall not be used if found to be defective. 3. Employees shall be familiar with the operation of the lift before use. 4. Level indicators, if equipped, shall be operable. 5. Ensure stable and proper positioning prior to operating the lift. 6. If the lift is equipped with outriggers they shall be set before use. 7. Approved fall protection shall be used when in the basket. Refer to Section 2.10 Fall Protection. 8. A bucket self-rescue device shall be available for use at all times. If no ground worker is present, the device shall be in the basket. 9. Work shall be performed only on grounded lines and equipment. 10. Personal protective grounds shall not be applied from an uninsulated aerial lift. 11. Refer to Section 5.4 Minimum Approach Distances for information on MAD. 12. For information on grounding lifts, refer to Section 5.5 Protective Grounding. 13. When the basket is occupied, the lower controls shall only be used in the event of an emergency. 14. This equipment is not intended for use on the road. The lift shall be transported using an approved trailer. 15. When moving or transporting the lift, the basket shall be lowered to a safe level. 	
3.7.6 Definitions	MAD : Minimum Approach Distance	

Section 3	Operation of Motor Vehicles and Equipment	
3.8	Crane Operation	Effective Date: 1/1/2016 Revised: 1/1/2017
3.8.1 Purpose	This section provides information and safe work practices to ensure a safe work environment for employees who work around, operate or inspect cranes.	
3.8.2 Responsibilities	<ol style="list-style-type: none"> 1. The Company shall comply with the crane manufacturer's specifications and limitations. 2. The Company shall engage a qualified third party to conduct a thorough annual inspection of all cranes. 3. The Company shall maintain a record of the dates and results of all inspections for each crane. 4. The Company shall ensure that only properly qualified employees operate cranes. 5. Employees shall be responsible for safe crane operation. 6. Employees shall use proper rigging techniques when moving loads. 7. Employees shall know and use proper signaling. 	
3.8.3 Requirements	<ol style="list-style-type: none"> 1. Qualified Crane Operator 2. Qualified Rigger 3. Qualified Signal Person 4. Qualified Site Supervisor and Lift Director (under specific circumstances can be performed by the same person). 5. PPE 6. Manufacturer's Operating Manual 	
3.8.4 Risk Identification	<ol style="list-style-type: none"> 1. Personal injury or property damage caused by equipment failure. 2. Improper operation of the boom resulting in equipment and property damage or personal injury. 3. Improper rigging resulting in unsecured or dropped loads. 4. Roll over hazards caused by ground conditions or terrain. 5. Serious injury caused by electrical contact. 6. High pressure hydraulic oil hoses failing. 	
3.8.5 Safe Work Practices	<ol style="list-style-type: none"> 1. General <ol style="list-style-type: none"> a. Digger-derricks are exempt from crane requirements per OSHA Standard (29 C.F.R. 1926 subpart CC). b. A lift plan shall be conducted as part of the risk assessment process. c. Critical lifts require a dedicated Lift Director. d. Manufacturer's recommendations for capacity and use shall be followed for all rigging equipment. e. No modification to any crane shall be made without the manufacturer's written approval. f. Rated load capacities shall be posted on all cranes. Instructions or warnings shall be visible to the operator while at the control station. 	

- g. Cranes with variable angle booms shall be equipped with a boom angle indicator, readily visible to the operator.
- h. Rigging shall only be done by a qualified rigger.
- i. Signaling shall only be done by a qualified signal person.
- j. Crane guidance hand signals shall be those prescribed by the applicable ANSI standard. Refer to **Attachment A**.
- k. Wire rope safety factors shall be applied with the applicable ANSI Standard.
- l. Wire rope shall be taken out of service in accordance with the applicable ANSI standard.
- m. In the absence of properly grounded or barricaded lines, MAD distance for cranes shall be followed. For distance charts, refer to **Section 5.4 Minimum Approach Distances**.
- n. If any part of the crane can enter the MAD zone, all items i through iv must be followed:
 - i. A signal person shall be appointed. It is their sole responsibility to warn the operator whenever the operator or any part of the crane approaches the MAD zone.
 - ii. A meeting with the operator, the signal person, and other workers in the area must occur to review location of power lines and steps that will be implemented to prevent encroachment.
 - iii. Any taglines used must be non-conductive.
 - iv. Erect and maintain an elevated warning line, barricade or line of signs equipped with hi-vis markings in view of the operator at the MAD zone distance.
- o. During crane operation where communication is difficult between the operator and the signaler, a hands free cell phone may be used to improve communications. This is the only permitted cell phone use by those involved in the lift.

2. Inspection Requirements

- a. All mobile and overhead cranes shall be inspected as follows:
 - i. Prior to each use by qualified employee.
 - ii. Monthly by qualified employee.
 - iii. Annually by a third party qualified crane technician
- b. Any problems with the crane shall be reported with the Vehicle and Equipment Maintenance Request Form. Any defective crane shall be tagged out-of-service.
- c. http://intra.versantpower.com//resources/forms/vehicle_inspection.cfm
- d. Rigging equipment shall be inspected prior to each use.

3. Crawler and Truck Cranes

- a. Prior to operating the crane, ensure proper positioning per the manufacturer's specifications.
- b. Proper blocking techniques shall be used to level the crane.

4. Overhead and Gantry Cranes

- a. The rated capacity of the crane shall be plainly marked on each side of the crane.
- b. If the crane has more than one hoisting unit, each hoist shall have its rated capacity marked on it or its load block, and this marking shall be clearly legible from the ground or floor.
- c. Bridge trucks shall be equipped with sweeps which extend below the top of the rail and project in front of the truck wheels.
- d. During operation, tension shall be maintained on the cable at all times to prevent sheave misalignment.
- e. Operators shall ensure the Crane approaches travel stops slowly.

5. Hoisted and Suspended Personnel Platforms

















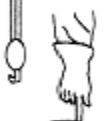
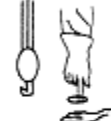

- a. Only approved equipment shall be used as a man basket.
- b. A proof test to 125% of the platforms' rated capacity shall be conducted at each new job site. The load shall be evenly distributed and suspended for 5 minutes. This only has to be done once, prior to the work starting.
- c. A trial lift (which can be combined with the proof test) shall be conducted for each location the platform will be lifted to. This trial lift shall also be repeated each time the crane is moved to a new position. During the trial lift the basket shall be loaded to at least the anticipated lift weight.
- d. The crane shall be level within one percent of level grade and located on firm footing. Cranes equipped with outriggers shall have them all fully deployed following manufacturer's specifications.
- e. Man baskets shall be used only for employees, their tools and the materials necessary to do their work.
- f. The man basket shall not be loaded in excess of its rated load capacity.
- g. Weight in the man basket shall be evenly distributed.
- h. The total weight of the loaded man basket and related rigging shall not exceed 50 percent of the rated capacity of the crane.
- i. Load lines shall be capable of supporting at least seven times the maximum intended load.

6. Work Practices for Hoisted and Suspended Personnel Platforms

- a. Persons being lifted shall remain in continuous sight of and in direct communication with the operator or signal person.
- b. Fall protection shall be worn while in the man basket.
- c. The crane operator shall remain at the controls at all times when the platform is occupied.
- d. All crane components shall be mechanically secured when the man basket is in a stationary working position.
- e. Employees shall keep all parts of the body inside the platform during raising, lowering, and positioning.
- f. Before employees enter or exit a hoisted personnel platform that is not landed, the platform shall be secured to the structure where the work is to be performed.

	<ul style="list-style-type: none"> g. Tag lines should be used to stabilize the platform. h. Lifting employees shall be promptly discontinued upon indication of any dangerous weather conditions or other impending danger. i. Lifting employees while the crane is traveling is prohibited.
<p>3.8.6 Definitions</p>	<p>Critical Lift: any lift that:</p> <ol style="list-style-type: none"> 1. utilizes multiple cranes; 2. exceeds 85% of total capacity of the crane at lift radius; 3. is over an occupied structure or public street; 4. lifts an item of high value or long replacement time. <p>Hoisted Personnel Platform: a platform that is suspended from a crane or derrick by a wire rope.</p> <p>Lift Director: a person responsible for each lift or series of lifts on a jobsite. Ensures compliance with crane safety plan and appropriate lift plan.</p> <p>Operator: the employee designated to directly control or operate the crane and all of its functions. Operators are employees who have been Qualified and/or Certified by Versant Power as Crane Operators.</p> <p>Qualified: a person who, by possession of a recognized degree, certificate, or professional standing, or who by extensive knowledge, training and experience, successfully demonstrates the ability to solve problems relating to the subject matter, the work or the project</p> <p>Qualified Crane Technician: an entity that, due to its independence and expertise, has demonstrated that it is competent in accurately assessing the condition of cranes through a mechanical inspection.</p> <p>Qualified Rigger: an employee whom the Company has designated as meeting the definition of a qualified employee (above) with regard to proper rigging of suspended loads.</p> <p>Signal Person: an employee whom the Company has designated qualified with regard to the proper signaling to a Crane Operator hoisting suspended loads.</p> <p>Suspended Personnel Platform: a platform that is fixed at the end of a crane or derrick boom.</p>

Universal Mobile Crane Hand Signals

 Main Hoist	 Auxiliary Hoist	 Hoist Load	 Hoist Load Slowly	 Stop
 Raise Boom	 Raise Boom & Lower Load	 Lower Load	 Lower Load Slowly	 Emergency Stop
 Lower Boom	 Lower Boom & Raise Load	 Swing Boom	 Swing Boom Slowly	 Travel (mobile eqpt)
 Retract Boom 2 hands	 Retract Boom 1 hand	 Extend Boom 2 hands	 Extend Boom 1 hand	 Dog Everything

Section 3	Operation of Motor Vehicles and Equipment	
3.9	Trailers and Load Securement	Effective Date: 1/1/2016 Revised: 3/1/2019
3.9.1 Purpose	Proper trailer use and load securement while transporting materials, tools, or equipment prevents unsecured loads from resulting in property damage or personal injuries. This section provides information and safe work practices on the safe use of trailers and proper load securement.	
3.9.2 Responsibilities	<ol style="list-style-type: none"> 1. The Company is responsible for providing safe trailers and load securement devices. 2. Employees shall obey all state and federal laws, rules and regulations. 3. Employees shall be familiar with the trailer before using. 4. Employees shall be familiar with load securement before hauling loads. 	
3.9.3 Requirements	<ol style="list-style-type: none"> 1. Valid Driver’s License 2. Load securement devices, as needed 3. Permits, if required 4. Spotter vehicle, if applicable 	
3.9.4 Risk Identification	<ol style="list-style-type: none"> 1. Unbalanced and unsecured loads shifting. 2. Roll overs initiated by overloaded trailers. 3. Improperly hitched trailer becoming unattached. 4. Property damage or personal injury when backing loaded trailers. 5. Oversize or over height loads failing to clear existing structures or vehicles during transport. 	
3.9.5 Safe Work Practices	<ol style="list-style-type: none"> 1. General <ol style="list-style-type: none"> a. Trailers are to be considered part of the vehicle when doing pre-use inspections. Special attention should be paid to ensure that: <ol style="list-style-type: none"> i. all lights are working ii. brakes are working iii. tires have adequate tread and are free of cuts or dry rot iv. there are no major structural defects v. the breakaway device is in working condition, if so equipped b. All trailers shall be labeled with the gross vehicle weight rating. c. Loads shall not exceed the trailers rated capacity. d. The combined weight of the truck, trailer and load shall not exceed the registered or permitted weight. e. Loads shall be inspected and measured as needed for over height/over width per pre-trip inspection checklist. f. Employee shall have proper licensing for the truck and trailer combination. g. When hauling an oversized load, all required signs (flags, lamps and reflectors) shall be properly and safely mounted and all 	

	<p>required permits in driver's possession.</p> <ul style="list-style-type: none"> h. The trailer tongue and ball hitch size shall be matched and adequately rated for the load. i. Employee shall ensure the trailer safety chains are secured to the vehicle. j. Employee shall ensure the tongue, pintle hitch or 5th wheel is securely latched into place. k. Trailer wheels should be chocked when trailer is unhooked from a vehicle. l. A spotter, if available, should be used when backing a trailer. Refer to Section 3.3 Backing and Parking for more information. <p>2. Load Securement</p> <ul style="list-style-type: none"> a. All load securement devices shall be inspected before use. b. Straps shall be installed to prevent them from being cut or abraded during use. c. Loose strap ends shall be secured. d. Loads shall be balanced and adequately secured. e. Refer to FMCSR (49 C.F.R. Part 393) for technical specifications on load securement. f. Refer to Section 3.9 Attachment A for general information on load securement. g. Any cargo in the back of a truck shall be contained, immobilized, or secured during transportation. Cargo nets supplied by Versant Power or the truck manufacturer shall be secured to cover the back of the truck prior to travelling to and from the work site. h. Hand lines, tackle blocks and other ropes shall not be hung on the outside of the vehicle. <p>3. Pole Trailer</p> <ul style="list-style-type: none"> a. When hauling poles, the trailer shall be extended to the length required to support the poles. b. Any material that projects more than four feet beyond the rear of the trailer must have a red or orange flag hung by day and a reflective flag, approved reflector or warning light by night. c. Poles in excess of 65' may require permits and the use of a spotter vehicle. d. Single axle/single tire pole dinkys should be placed on the back of the truck during transport when empty.
<p>3.9.6 Definitions</p>	<p>Breakaway device: a device that activates trailer brakes upon separation from the vehicle.</p> <p>FMCSR: Federal Motor Carrier Safety Regulations</p> <p>Spotter Vehicle: a vehicle which follows behind the main vehicle for the purpose of observing the load and communicating any issues with the driver.</p>

Load Securement

Topics covered under this Attachment:

- Tie-down Requirements
- Inspections of Secured Loads
- Working Load Limits
- Guidelines for Securing Light Duty Vehicles
- Guidelines for Securing Heavy Equipment
- Examples of Securing Wire reels and Cargo

Tie-downs

- Tie-downs shall be inspected for the following defects:
 - No knots or obvious damage
 - No distress
 - No weakened parts
 - No weakened sections
- Each tie-down must be attached and secured so that it does not become loose or unfastened, open, or release during transit.
- Edge protection must be used if a tie-down could be cut or torn when touching an article of cargo. The edge protection itself must also resist crushing, cutting, and abrasion.
- Position the tie-downs as symmetrically as possible over the length of the article.
- Position the tie-downs to preserve the integrity of the article.

How many tie-down's are required?

- 5ft or shorter and 1100lbs or lighter
 - 1 tie-down minimum
- 5ft or shorter and over 1100lbs
 - 2 tie-downs minimum
- More than 5ft but less than 10ft
 - 2 tie-downs minimum
- Longer than 10ft
 - 2 tie-downs + 1 tie-down for every 10ft or part thereof
- All Cargo
 - 1 tie-down for every 10ft or part thereof

Driver Inspection Checklist

PRE-TRIP

- Make sure that cargo is properly distributed and adequately secured.
- Make sure that all securement equipment and vehicle structures are in good working order and used consistent with their capability.
- Stow vehicle equipment.
- Make sure that nothing obscures front and side views or interferes with the ability to drive the vehicle.

PERIODIC INSPECTIONS DURING TRANSIT

- Inspect cargo and securing devices.
- Adjust cargo or load securement devices as necessary to ensure that cargo cannot shift on or within, or fall from, the commercial motor vehicle.
- As necessary, add more securing devices.

Inspection Requirements

The driver is responsible for the following cargo securement inspection activities.

Driver Action Required	Pre-Trip	Within first 50 miles	When duty status of driver changes	At 3 hour intervals or 150 miles, whichever is first
Inspect Cargo and Securing Devices	✓	✓	✓	✓
Adjust Cargo and/or Securing Devices	As Necessary	As Necessary	As Necessary	As Necessary
Add Additional Securing Devices	As Necessary	As Necessary	As Necessary	As Necessary

Working Load Limit

- The Working Load Limit (WLL) is the maximum load that may be applied to a component of a cargo securement system during normal service.
- The WLL is usually assigned by the component manufacturer.
- The WLL for a tie-down is the lowest WLL of any of its parts, or the WLL of the anchor points it is attached to, whichever is less. Every device contributes to the WLL of the securement system.
- The minimum WLL requirement for the securement system is 50% of the weight of the cargo.

Automobiles/UTV's/Light Trucks

Securing automobiles, light trucks, and vans that weigh 10,000lb or less.

- Use at least two tie-downs at both the front and rear of the cargo to prevent movement.
 - Side-to-side
 - Forward and rearward
 - Vertically

Edge protectors

- Not required for synthetic webbing at points where the webbing comes in contact with the tires.

Note: Picture indicates acceptable tie-down locations.

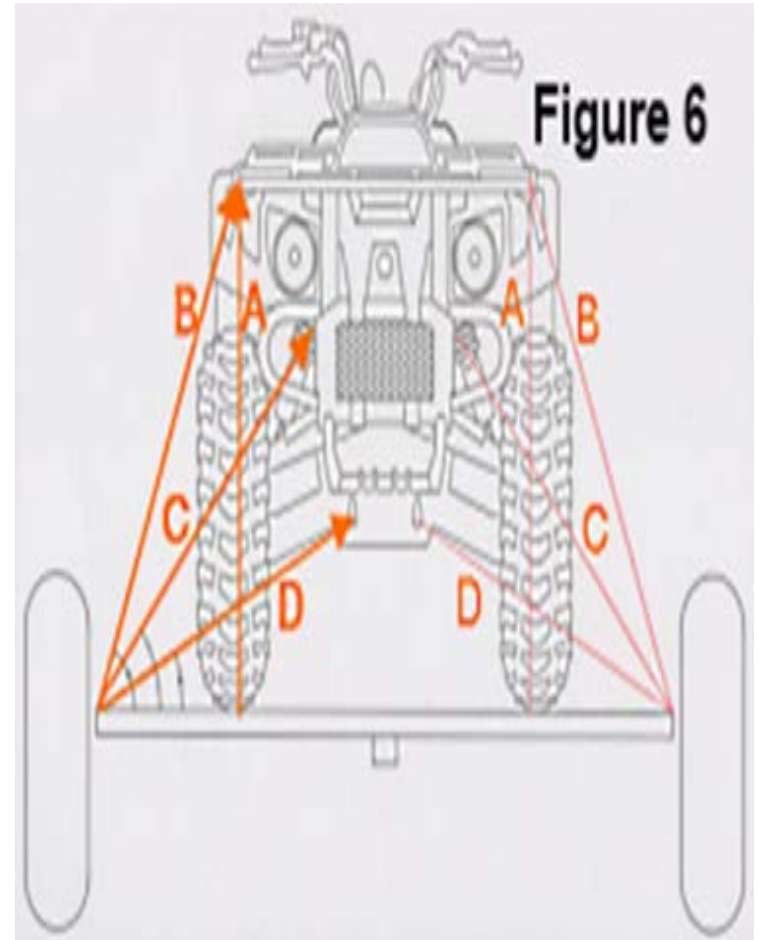

Heavy Equipment Securement

Securing machinery that weighs more than 10,000 lb.

- Lower and secure all accessory equipment (hydraulic shovels, booms, etc.).
- Restrain articulated vehicles to prevent articulation while in transit.
- Set the parking brake on the equipment being transported.

Tie-down requirements

- Restrain cargo using a minimum of four tie-downs, each having a Working Load Limit (WLL) of at least 5,000 lb.
- Tie-downs need to prevent cargo movement
 - Side-to-side
 - Forward and rearward
 - Vertical
- Attach tie-downs either at the front and rear of the vehicle or at the mounting points on the vehicle designed for securement.



Securing Reels of Wire

- All metal coil shipments that, individually or together, weigh 5,000lb or more must be secured according to specific requirements.
- Metal coils that weigh less than 5,000lb may be secured according to general securement requirements.

Types of Coil Orientations:

- Eyes vertical
- Eyes crosswise
- Eyes lengthwise

Type of Vehicle Required:

- Flatbed vehicles
- Sided vehicles with or without anchor points

Requirements for securing a single coil eye positioned lengthways

- To prevent the coil from tipping forward, rearward, and sideways, arrange tie-downs to include the following:
 - Attach at least one tie-down diagonally across eye of coil from left side of vehicle to right side of vehicle.
 - Attach at least one tie-down diagonally across eye of coil from right side of vehicle to left side of vehicle.
 - Attach at least one tie-down over eye of coil from side-to-side.
- To prevent forward movement, use one of the following:
 - Blocking
 - Bracing
 - Friction mats
 - A tie-down passed around the front of the coil.

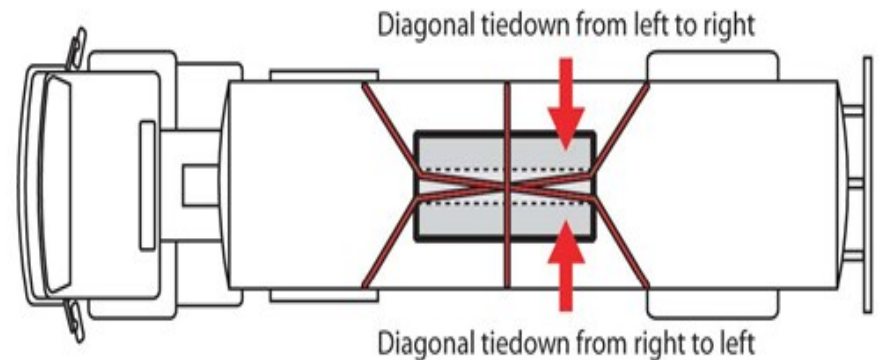

Requirements for securing a row of coils eye positioned vertically

- Attach at least one tie-down against the front row of coils to restrain against forward motion.
 - If possible the angle between tie-down and deck should be less than 45° , when viewed from the side of the vehicle.
- Attach at least one tie-down against the rear row of coils to restrain against rearward motion.
 - If possible the angle between tie-down and deck should be less than 45° , when viewed from the side of the vehicle.
- Attach at least one tie-down over top of each coil or side-by-side row of coils to restrain against vertical motion.
- Tie-downs going over the top of coil must be as close as possible to the eye of the coil.
- Arrange tie-downs, blocking, or bracing to prevent shifting or tipping in any direction.

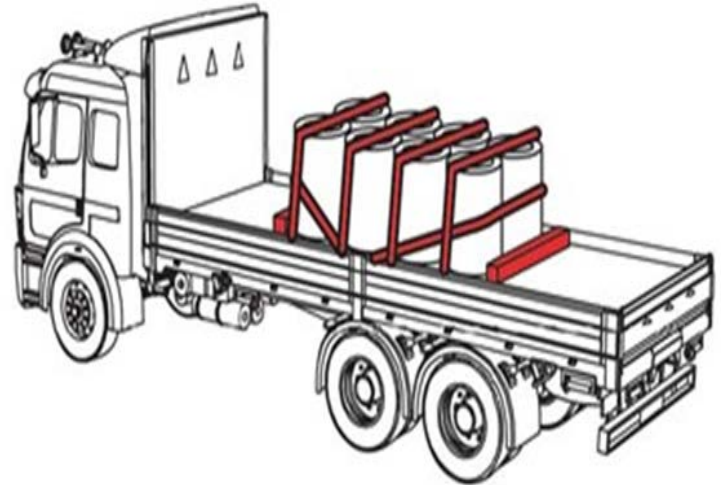

Section 3	Operation of Motor Vehicles and Equipment	
3.10	Powered Industrial Truck (Forklift)	Effective Date: 1/1/2016 Revised:9/1/2019
3.10.1 Purpose	To promote a positive and proactive approach to safe powered industrial truck operation, this section provides safe work practices when operating a powered industrial truck (“forklift”).	
3.10.2 Responsibilities	<ol style="list-style-type: none"> 1. The Company shall implement and administer the forklift training program in accordance with OSHA Regulations. 2. The Company shall maintain written records of the frequent and annual inspections performed by the forklift owner. 3. The Company shall ensure that only trained and qualified employees use forklifts. 4. The employee is responsible for adhering to the safe work practices when operating a forklift. 	
3.10.3 Requirements	<ol style="list-style-type: none"> 1. Employee Certification 2. PPE 	
3.10.4 Risk Identification	<ol style="list-style-type: none"> 1. Personal injury or property damage caused by equipment failure or changing conditions in the operating environment. 2. Improper forklift operation resulting in equipment and property damage or personal injury. 3. Unbalanced and unsecured loads shifting. 4. Rollovers caused by improper use or loading techniques. 	
3.10.5 Safe Work Practices	<ol style="list-style-type: none"> 1. General <ol style="list-style-type: none"> a. Only certified employees shall operate a forklift. b. Refer to Section 9.2 Battery Charging for information on charging and maintenance of batteries. c. A pre-use inspection shall be performed. Any forklift not in safe operating condition shall be tagged out of service and shall be reported using the Vehicle and Equipment Maintenance Request Form. http://intra.versantpower.com/resources/forms/vehicle_inspection.cfm d. Completed Pre-use forklift inspection forms shall be kept for 30 days by the department responsible for operating forklift. The completed forms will be available for review. 2. Traveling <ol style="list-style-type: none"> a. Pedestrians shall have the right of way at all times. The operator should make eye contact with the pedestrian before moving the forklift. b. The operator shall stop and sound horn at all blind corners, doorways, aisles and intersections and at other locations where vision is 	

obstructed.

- c. The operator shall travel at a speed that will allow for safe stopping.
- d. The operator shall travel at a safe speed for the existing conditions, such as slippery floors and ascending or descending grades.
- e. Whether loaded or empty, forks should be positioned as low as possible, but high enough to clear uneven surfaces.
- f. On inclines, loaded forklifts shall be driven with the load on the upgrade side of the operator whether ascending or descending.
- g. The operator should always have a clear view of the path of travel, including operation in reverse when a load obstructs the forward view.

3. Operation

- a. Forklifts shall be operated in accordance with the manufacturer's recommendations.
- b. Forklifts should be operated in well ventilated areas; if this is not available employees should limit exposure to exhaust fumes
- c. The operator is the only approved rider on the forklift and shall be in the driver's seat while operating the forklift. No others are permitted on the forklift.
- d. When provided, seatbelt or other restraint systems shall be worn at all times.
- e. Operator shall ensure that their arms, legs and head remain inside the forklift when in operation.
- f. When an operator is going to be more than 25 feet away from the forklift or out of sight of it, the forklift is considered to be left unattended and the operator shall:
 - i. lower the forks completely
 - ii. neutralize controls
 - iii. turn off the ignition
 - iv. set the brake
 - v. chock the wheels if parked on an incline
- g. When the operator is less than 25 feet away and within sight of the forklift they must:
 - i. lower the forks completely
 - ii. put controls in the neutral position
 - iii. set the brake
- h. Use caution when refueling any forklift. Fuel tanks shall not be filled while the engine is running.
- i. Batteries must be disconnected prior to repairs to the electrical system.
- j. Employees shall only be elevated by a forklift designed and approved for that purpose. Employees shall use proper fall protection while elevated. Refer to **Section 2.10 Fall Protection**.

4. Loading

- a. No person is permitted to stand or pass under the elevated portion of any forklift whether loaded or empty.
- b. Loads should not be raised or lowered while traveling.

	<ul style="list-style-type: none"> c. All loads shall be fastened or positioned to prevent tipping or falling. d. Capacity charts shall not be exceeded. e. Lift bars that are movable or replaceable shall be held firmly in place by a proper securing pin or other approved device. f. Vehicles or trailers being loaded or unloaded from a loading dock shall have their wheels chocked. g. Fork lift operator shall not store unsecured material on a pallet rack beam higher than 8 feet from the floor. h. When lifting loads with uneven weight distribution, the fork lift operator shall carry the load with the heaviest side toward the fork lift mast. <p>5. Attachments</p> <ul style="list-style-type: none"> a. Any attachments not provided by the manufacturer must be approved by a qualified third party. b. All attachments shall be properly secured. Improvised methods shall not be used. c. Attachments may require the use of revised capacity charts.
<p>3.10.6 Definitions</p>	<p>Forklift: includes fork trucks, motorized hand trucks and pallet jacks</p>

Section 3	Employee Operation of Motor Vehicles and Equipment	
3.11	Special Equipment	Effective Date: 1/1/2016 Revised: 1/1/2017
3.11.1 Purpose	To promote safe operation of special equipment that may not be utilized on a daily basis, this section provides safe work practices regarding the use of this equipment.	
3.11.2 Responsibilities	<ol style="list-style-type: none"> 1. The Company is responsible for providing the appropriate equipment and required training to operate the equipment. 2. Employees are responsible for observing all state laws, rules and regulations when operating equipment. 	
3.11.3 Requirements	<ol style="list-style-type: none"> 1. Valid Driver's License 2. Vehicle Inspection Checklist Form 3. Permits, if required 4. Property owner's permission, if possible 5. PPE 	
3.11.4 Risk Identification	<ol style="list-style-type: none"> 1. Improper use of special equipment resulting in personal injury and property damage. 	
3.11.5 Safe Work Practices	<ol style="list-style-type: none"> 1. General <ol style="list-style-type: none"> a. Employees shall use equipment in accordance with the manufacturer's recommendations. b. Employees shall inspect equipment prior to use even if a Vehicle Inspection Checklist Form is not required. c. Employees shall respect all property when operating equipment. d. If the employee must gain access to private property without permission, the supervisor and Central Dispatch or System Operator shall be notified. e. The Employee shall close and secure any gates or fences immediately after passing through. f. When operating special equipment in which the operator has limited visibility or tight clearances, a spotter should be used. g. Employees should consider carrying first aid, trauma kit, and AED on board special equipment if practical and travel time back to retrieve such equipment is a concern. 2. Truck Tractor <ol style="list-style-type: none"> a. The truck tractor shall only be driven by a qualified and licensed employee. b. Proper permitting shall be obtained prior to operating the truck tractor, if required. c. The employee shall have the vehicle under control at all times. 	

	<p>d. Employees shall demonstrate proficiency to the Fleet Department prior to operating the truck tractor.</p> <p>3. Sno-Cat(Tucker)</p> <p>a. Employees should travel existing field roads on private property whenever possible.</p> <p>b. Employees should obtain the property owner's permission before entering private property.</p> <p>c. Although the Sno-Cat is designed for five person capacity and is not top heavy, care shall be taken to avoid operating on excessively steep grades or side angles.</p> <p>4. Snowmobile, ATV, UTV</p> <p>a. The following PPE shall be worn by driver and passengers on any ATV, UTV, snowmobile, etc.:</p> <p style="padding-left: 40px;">i. Helmets designed for use with ATVs or snowmobiles (not required while using equipment that provides seatbelts or a cab)</p> <p style="padding-left: 40px;">ii. Suitable eyewear such as safety glasses or helmet face shield.</p> <p>b. Three wheeled ATVs shall not be used.</p> <p>c. Employee shall be experienced and have sufficient instruction in the operation of the equipment prior to use.</p> <p>d. Employee shall have the vehicle under control at all times.</p> <p>e. Extreme care and good judgment shall be exercised while operating this equipment. Special attention shall be given to cables, rocks, stumps, logs, gravel pits, fences, brooks, streams, rivers, etc.</p> <p>5. Flextrack Off Road Equipment</p> <p>a. Only qualified employees shall be permitted to operate this equipment.</p> <p>b. The operator shall determine where the equipment can be safely operated.</p> <p>c. If the equipment is fitted with a bucket, the rules pertaining to aerial lifts in Section 3.5 Insulated Aerial Lifts shall apply.</p> <p>d. If the equipment is fitted with a digger-derrick, the rules pertaining to digger-derrick in Section 3.6 Digger-Derricks shall apply.</p> <p>e. If the equipment is used for excavations and trenching, the safe work practices outlined in Section 2.14 Excavations and Trenching shall apply.</p>
<p>3.11.6 Definitions</p>	<p>ATV: All-Terrain Vehicle</p> <p>Flextrack Off Road Equipment: any tracked vehicle designed for off road transportation and use.</p>

	<p>PPE: Personal Protective Equipment</p> <p>Qualified Operator: qualified by the company and proficient in its use or operation of the equipment.</p> <p>Sno-cat: a large tracked vehicle designed for off road transportation and use.</p> <p>Truck Tractor: a short truck with a drivers cab and no body designed for hauling a trailer or semi-trailer.</p> <p>UTV: Utility Terrain Vehicle</p>
--	--

Section 4	Communications	
4.1	Cellular Telephone Use	Effective Date: 1/1/2016 Revised:
4.1.1 Purpose	This section provides information regarding the safe use of cellular telephones (cell phones) when considering the need to use a cell phone while driving or performing other duties.	
4.1.2 Responsibilities	1. Employees are responsible for following the safe work practices when using cellular telephones.	
4.1.3 Requirements	1. Cell phones and associated hands-free hardware	
4.1.4 Risk Identification	1. Being distracted while driving or completing other tasks 2. Cell phone use around fuel vapors 3. Battery failure resulting in fire or burn 4. Using damaged cell phones or equipment	
4.1.5 Safe Work Practices	1. General <ol style="list-style-type: none"> a. Employees shall follow all federal and state laws and regulations regarding use of cell phones. b. These safe work practices apply to <u>all</u> employees. c. Employees who operate a commercial motor vehicle shall refer to <i>Section 3.1 Qualifications and Responsibilities</i> for additional information. d. Crane Operators shall refer to <i>Section 3.8 Crane Operation</i> for additional information. e. Employees should be familiar with the manufacturer’s recommendations and warnings regarding cell phone use. f. All company issued cell phones shall have the GPS tracking capability set to “ON” at all times. g. Employees shall not be distracted by a cell phone while performing their duties. h. Damaged cell phones and equipment shall not be used. i. Cell phones shall not be used when refueling vehicles or equipment. j. The battery in a cell phone is a potential fire hazard if it becomes overheated. k. Cell phones shall be safely stored when driving so as not to become a hazard. 2. Use While Driving <ol style="list-style-type: none"> a. Employees shall focus on the primary task of driving and limit the number and duration of phone calls. b. Whenever possible, passengers shall handle cell phone 	

	<p>communications.</p> <p>c. Hands free cell phone use is allowed while driving.</p> <p>d. Dialing a cell phone while driving is <u>prohibited</u>. However, a driver may initiate, answer, or terminate a call by touching a single button on a cell phone, earpiece, steering wheel, or instrument panel provided they do not move out of their normal seated position.</p> <p>e. Texting and internet use is <u>prohibited</u> while driving, including when stopped at a traffic signal.</p>
4.1.6 Definitions	<p>Fuel Vapors: flammable vapors present in the air while transferring fuel</p> <p>GPS: Global Positioning System</p>

Section 4	Communications	
4.2	Two-Way Radios	Effective Date: 1/1/2016 Revised:
4.2.1 Purpose	Two-way radios are a critical part of the Company’s communication system. This section provides safe work practices on how to effectively use two-way radios to ensure employee safety while performing work activities or in the event of an emergency.	
4.2.2 Responsibilities	<ol style="list-style-type: none"> 1. Employees are responsible for following the safe work practices. 2. Employees are responsible for reporting any issues with the two-way radio system. 	
4.2.3 Requirements	<ol style="list-style-type: none"> 3. Two-Way Radio Equipment 4. Radio Trouble Ticket Form 5. Radio Channel Programming List 	
4.2.4 Risk Identification	<ol style="list-style-type: none"> 1. Distraction from primary task while using two-way radio 2. RF exposure 3. Electrical/structural contact with vehicle mounted antenna 4. Critical message missed due to radio being set to scan mode 5. Not having a clear channel to communicate during an emergency 6. Non-working radios outside normal operating region 	
4.2.5 Safe Work Practices	<ol style="list-style-type: none"> 1. Emergency Use <ol style="list-style-type: none"> a. Code 99 - In the event of an emergency, declare a Code 99 over the company radio system by making contact with Central Dispatch and/or System Operations. All other radio transmissions in the broadcast area shall cease until the Code 99 is cleared by Central Dispatch or System Operations. <u>Example of how to declare a Code 99:</u> <ul style="list-style-type: none"> ➤ “Truck 110 to Central Dispatch, we have a Code 99, repeat a Code 99” ➤ “ This is Central Dispatch, we have a Code 99, go ahead Truck 110” <u>Use the following message to clear a Code 99:</u> <ul style="list-style-type: none"> ➤ “This is Central Dispatch, Code 99 clear, repeat Code 99 clear” b. Code 1000 – <u>Only</u> System Operations may declare a Code 1000 to clear all radio channels and clear a Code 1000 to resume normal communications. <u>Use the following message to declare a Code 1000:</u> 	

- “ This is System Operations, we have a Code 1000, repeat a Code 1000”

Use the following message to clear a Code 1000:

- “ This is System Operations, Code 1000 clear, repeat Code 1000 clear”

- c. **LifeFlight** - LifeFlight emergency services have the Company’s radio frequencies and can communicate directly with ground crews. This is applicable throughout the Company’s service territory.

2. General

- a. Refer to **Section 4.2 Attachment A** for a listing of Company radio channels and coverage areas.
- b. If working in an area with known reception problems, ensure an alternate communication plan is in place. Use check-in/check-out procedures.
- c. Radio use shall not interfere with the safe operation of equipment, especially while driving.
- d. Whenever possible, passengers shall conduct two-way radio communications.
- e. The radio within each company vehicle shall have the radio identification number clearly marked on the radio. The user of the radio shall use this number for identification during communication.
- f. Every company radio should have a listing of company radio channels on or near the device.
- g. Radio operators shall be familiar with the scan function of the radio. When the scan function is turned on some communication may be missed.
- h. The two-way radio system used by the Company is licensed by the FCC and is to be used only for official company business.
- i. Sensitive information shall not be disclosed over the radio. If the information is sensitive in nature, use a telephone instead of the two-way radio system.
- j. Radio etiquette:
 - i. Ensure the desired channel is clear before beginning a new transmission.
 - ii. Radio usage priority is:
 - 1 - Emergency,
 - 2 - Transmission switching,
 - 3 - Distribution switching, and
 - 4 - Day-to-day operations, in that order.
 - iii. Radio communication should follow this general sequence:
 1. Example – truck calling Central Dispatch:
 - “Truck 703 to Central Dispatch”
 - “Go ahead, Truck 703”

- Truck states message
- Central Dispatch repeats back message
- Truck confirms
- “Central Dispatch clear”
- “Truck 703 clear”

2. Example – Central Dispatch calling truck:

- “Central Dispatch to Truck 311”
- “Truck 311, go ahead Central Dispatch”
- Central Dispatch states message
- Truck repeats back message
- Central Dispatch confirms
- “Truck 311 clear”
- “Central Dispatch clear”

- k. If using radios for critical functions such as pulling conductor, test radios at respective work locations immediately prior to starting the critical function.
- l. Prior to entering energized work locations or structures, the vehicle or equipment operator shall verify the two-way radio antenna has proper clearance.
- m. To limit RF exposure, do not operate the transmitter of a mobile radio when someone outside the vehicle is within 2 feet of the antenna.
- n. Do not hold transmit (PTT) switch on when not trying to transmit.
- o. Do not allow unauthorized persons to operate any radio equipment.
- p. Do not operate a transmitter near unshielded electrical blasting caps or in an explosive atmosphere unless it is specifically qualified for such use.
- q. All radio equipment shall be installed and maintained by a qualified person.
 - i. Use “Radio Trouble” ticket to report radio equipment and coverage problems.
<http://intra.versantpower.com/resources/forms/RadioTrouble.cfm>
 - ii. If a coverage problem is identified, a Hazardous Condition Report shall be filed by the company communications engineer or supervisor.
<http://intra.versantpower.com/resources/IncidentReporting/Incidents.cfm>
- r. In the Fort Kent division it is required to take a satellite phone when working in the Allagash region.
- s. If the normal communications link fails in Central Dispatch or System Operations, the backup communications link (separate radio) located at these facilities shall be used.

3. Three-Part Communication

- a. Communications over the Company radio system should be done using three-part communication.

	<p>b. Refer to Section 6.2 Switching and Tagging Communication regarding three-part communication.</p>
<p>4.2.6 Definitions</p>	<p>Check-in/check-out Procedures: notify dispatch before entering an area with coverage problems. Confirm with dispatch when clear of area.</p> <p>Code 99: clears a single radio channel or broadcast area. In the case of an emergency, a Code 99 is declared to clear that radio channel during the emergency. Radio silence must be observed by all parties not involved in the emergency until the Code 99 is cleared.</p> <p>Code 1000: clears radio traffic system-wide. In the case of a system-wide emergency, System Operations can declare a Code 1000. Radio silence must be observed by all parties not involved in the emergency until the Code 1000 is cleared.</p> <p>FCC: Federal Communications Commission</p> <p>LifeFlight: state wide helicopter service providing scene response and critical care inter-facility transfer.</p> <p>RF: Radio Frequency</p> <p>PTT: Push-to-talk</p>

Versant Power 2-Way Radio Channels

Southern Operating Region (SOR)

Revised 11/3/16 - ch 35 now linked & not dedicated to meters

<u>Division</u>	<u>CHANNEL</u>	<u>Name</u>	<u>Location</u>	<u>Notes</u>
BANGOR	10	Blackcap	Blackcap Mtn, Eddington	
	12	Blackcap	Blackcap Mtn, Eddington	Repeater for truck-to-truck in Bangor area
	14	Charleston	Bull Hill, Charleston	
	15	Blackcap	Blackcap Mtn, Eddington	Bangor Meter Channel
LINCOLN	20	Bagley	Bagley Mtn, Lincoln	
	21	Sebec	Tower Rd, Sebec	
	22	Charleston	Bull Hill, Charleston	
	23	Brownville	Stickney Hill, Brownville	
	24	Millinocket	Hammond Ridge, Millinocket	
ELLSWORTH (aka Hancock)	30	Blue Hill	Blue Hill	
	31	Franklin	Martins Ridge, Franklin	
	32	Schoodic	Schoodic Mtn, Sullivan	
	33	Seal Harbor	Upland Rd, Seal Harbor	
	35	Bald	Bald Mtn, Dedham	
MACHIAS (aka Washington)	40	Pumpkin Ridge	Pumpkin Ridge, Machias	
	41	Cooper	Cooper Hill, Cooper	
	42	Eastport	Eastport Sub	
	43	Franklin	Martins Ridge, Franklin	
	44	Schoodic		
Truck to Truck	13			Direct truck-to-truck anywhere
Note - Within each division, those channels shown in Bold are linked-				
they will repeat from any of the others and from central dispatch or System Operations				

Northern operating Region (NOR)

<u>Division</u>	<u>CHAN</u>	<u>Name</u>	<u>Location</u>	<u>Notes</u>
Presque Isle	1	Presque Isle	Parkhurst Hill	
		P.I. Repeater	Parkhurst Hill	aka "Parkhurst" or "Trial Repeater"
	2	Ashland	Ashland	
	11	Bridgewater	Number Nine Mtn	
Fort Kent	3	Ft Kent	Daigle Hill	
	5	St Francis	Morrison Mtn	
	4	Madawaska	Cyr Mtn	
Island Falls	6	Island Falls	Robinson Mtn	aka "May Mtn"
	7	Truck Direct	n/a	
	8	Cable Pull	n/a	
	9	Weather North		
	10	Weather Ctrl		

Section 5	Transmission and Distribution	
5.1	Roles and Responsibilities of T&D Workers	Effective Date: 1/1/2016 Revised:
5.1.1 Purpose	This section provides information regarding the qualifications of employees who operate and maintain the Company's T&D system.	
5.1.2 Responsibilities	<ol style="list-style-type: none"> 1. The Company is responsible for training employees to safely operate and maintain the T&D system. 2. The Company is responsible for maintaining records regarding training and qualifications of employees. 3. The supervisor is responsible for the safe work performance of their employees. 4. The employee is responsible for performing their work duties safely when operating and maintaining T&D equipment. 	
5.1.3 Requirements	1. Progression Performance Criteria	
5.1.4 Risk Identification	1. Employees performing work for which they are not qualified.	
5.1.5 Safe Work Practices	<ol style="list-style-type: none"> 1. Classification of Line Workers <ol style="list-style-type: none"> a. The Line Department classifies its line employees as follows: <ol style="list-style-type: none"> i. Ground Worker ii. Apprentice iii. Apprentice(+) iv. 2nd Class v. 2nd Class (+) vi. 1st Class vii. Lead Line Worker b. The Line Department classifies its meter employees as follows: <ol style="list-style-type: none"> i. Meter Service Worker 1 ii. Meter Service Worker 2 iii. Meter Service Worker 3 c. Responsibilities of Line Department employees <ol style="list-style-type: none"> i. Employees shall know and understand the duties and responsibilities of each classification of worker. ii. Employees shall know and understand what tasks each classification of worker can perform. iii. Supervisors shall not assign tasks that are outside a worker's classification. iv. Line Department employees shall not complete tasks that are outside of their classification. v. Contact the Line Department for more information on 	

	<p style="text-align: center;">the Progression Performance Criteria.</p> <p>d. Refer to Section 5.1 Attachment A for a list of line worker classification permitted tasks.</p> <p>2. Classification of Power System Technical (PST) Workers</p> <p>a. The PST Department classifies its employees as follows:</p> <ul style="list-style-type: none"> i. Apprentice ii. Apprentice Technician iii. 3rd Class iv. 3rd Class (+) v. 2nd Class vi. 2nd Class (+) vii. 1st Class viii. 1st Class (+) ix. A (+) x. PST Lead Worker <p>b. The PST Department classifies its electro-mechanical employees as follows:</p> <ul style="list-style-type: none"> i. 3rd Class ii. 2nd Class iii. 2nd Class (+) iv. 1st Class <p>c. The PST Department classifies it meter employees as follows:</p> <ul style="list-style-type: none"> i. Meter Shop Tester ii. 3rd Class (+) iii. 2nd Class (+) iv. 1st Class (+) v. Meter Technician (+) <p>d. Responsibilities of PST Department employees</p> <ul style="list-style-type: none"> i. Employees shall know and understand the duties and responsibilities of each classification of worker. ii. Employees shall know and understand what tasks each classification of worker can perform. iii. Supervisors shall not assign tasks that are outside a worker’s classification. iv. PST employees shall not complete tasks that are outside of their classification. v. Contact the PST Department for more information on the Power System Technical Department Job Progression Performance Criteria.
<p>5.1.6 Definitions</p>	<p>Progression Performance Criteria: the set of criteria used by the Company to assess a worker’s qualifications and abilities.</p>

Versant Power

Line Department Job Progression **Performance Criteria**

September 11, 2020 ([see revision page](#))

Line Department Position Progression **& Intended Time Frames**

With the exception of Ground Worker, being six months, normal time spent in each classification will be twelve months. 12 months as a Line Worker 2nd Class(+) is mandatory with any exceptions being approved by Line and Safety Department managers. Attitude, safety, attention to detail, in the classroom and in the field, will be considered in addition to actual job performance in the company's decision to advance an employee to the next step in this progression. Inadequate performance in any area may be basis for additional time spent in any level of progression. When a Line Apprentice has successfully completed a level of their progression training in the field and in the classroom, they can perform all duties within that level in an unsupervised environment, providing they meet the "Working Alone" criteria in section 5.2 of the Versant Power Safety Manual.

<u>Classification</u>	<u>Duration:</u>
Ground Worker (Prob.)	6 Months
↓	
Apprentice Line Worker	12 Months
↓	
Apprentice Line Worker (+)	12 Months
↓	
Line Worker 2 nd Class	12 Months
↓	
Line Worker 2 nd Class (+)	12 Months
↓	
Line Worker 1 st Class	
↓	
Lead Line Worker	(by bid only)

Definition of Terms of Supervision

The following are the definitions for the terms used to describe the different levels of supervision. The initial level of supervision in a progression step will be constant unless otherwise noted in the Progression Document.

Limited Supervision: Defined as under the direction of a Line Worker 1st Class (or Lead Worker or Line Supervisor) who is on the “job” but not necessarily at the specific pole/work site. Example: A Line Worker 1st Class is overseeing junior rated personnel working on two different poles.

Close Supervision: Defined as under the direction of a Line Worker 1st Class (or Lead Worker or Line Supervisor) who is at the work site (on the ground) and is carefully watching and directing the junior worker through each move.

Constant Supervision: Defined as under the direction of a Line Worker 1st Class (or Lead Worker or Line Supervisor) who is at the work site and is either in a second bucket in the air or in hooks on the pole instructing and guiding each move the junior worker makes.

Qualified Tag Holder: Defined as a Tag Holder who is current on the Switching and Tagging list.

Line Supervisor: Direction/oversight from a Line Supervisor will be in training and emergency situations.

Supervision of Apprentice Pole Setting

1. At the butt of a pole:
 - a. An apprentice cannot work above his classification when at the pole butt setting poles in energized conductors; **unless** accompanied by and under **constant** supervision of a First Class Line Worker.
2. On the truck:
 - a. An apprentice can set a pole in energized conductors, under *close* supervision and regardless of voltage, if the apprentice remains at the control platform on the unit and deemed competent by the Line Worker 1st Class (or Lead Worker or Line Supervisor) who is at the work site.

Versant Power
LINE WORKER PROGRESSION EVALUATION

GROUND WORKER

EMPLOYEE _____

DIVISION / DEPARTMENT ____/____

CURRENT CLASSIFICATION _____

Classification Overview: The Ground Worker classification is the initial step in a comprehensive program to advance to Line Worker 1st Class. In order to progress to the Line Worker Apprentice classification; employees are expected to demonstrate qualifications in the Ground Worker competencies set forth below. Ground Workers are prohibited from working on energized conductors or conductors that could become energized at any voltage.

	Work Description	Not Exposed	Continue to Develop	Proficient	Notes
Safety	Demonstrates a thorough understanding of all applicable safety rules.				
	Is familiar with basic and emergency Versant Power radio procedures.				
Safe Work Practices	Demonstrates proper care and maintenance of personal protective equipment, including climbing tools.				
	Has developed satisfactory climbing skills.				
	Has satisfactorily completed pole top and bucket rescue procedures to qualify as “second seat” on bucket truck with other qualified line worker.				
	Has completed Apprenticeship Training Requirements for his classification, including CPR / First Aid training.				
	Has obtained requisite CDL Permit / License and begun OJT to operate line vehicles in a safe manner, including forklifts. Has received requisite Driver Training for CDL Operators.				
	Learned to safely operate digger/derrick and is familiar with pole setting procedures.				

	Is familiar with material handling / rigging requirements. Has attended rigging school (if offered during this time).				
	Is familiar with basic T&D Construction Standards, i.e., pole framing, hardware, guying.				
	Learned to safely operate various line tools necessary to perform job duties.				
	Prepares line materials / apparatus for installation i.e., transformers, cutouts, LA's, streetlights, etc.				
De-Energized Work	Demonstrates a basic knowledge of grounding procedures.				
	Demonstrates ability to attach secondary service cables to building from a ladder and make up service connections on de-energized equipment.				
	Assists in the installation of primary and secondary URD installations, and learns to make connections on de-energized equipment.				
	Introduction to transmission work. Assists others in performing dead line work (grounded circuit) on transmission lines.				
	Participates in service restoration activities during major storm events.				
Meter Work	Familiar with setting single phase self-contained meters for new services.				
Personal Accountability	Demonstrates a positive work attitude on a daily basis.				
	Attendance is satisfactory.				
	Is current with Apprenticeship Training Requirements				

Notes / Comments:

Signatures of Line Supervisor and Technical Trainer Performing Assessment:

_____ **Date** ___/___/___

_____ **Date** ___/___/___

Versant Power
LINE WORKER PROGRESSION EVALUATION

LINE WORKER APPRENTICE

EMPLOYEE _____

DIVISION / DEPARTMENT ____/____

CURRENT CLASSIFICATION _____

Classification Overview: The Line Worker Apprentice (LWA) Classification introduces the employee to more aerial work, while at the same time building on the basic skills attained in the Ground Worker Classification. As a LWA, the employee will begin to gain experience around energized equipment and may in the first 6 months, first accompanied by in training and then under Close supervision in the field, work on single phase, energized conductors up to 750 volts. During the second 6 months, the LWA may, first accompanied by in training and then under Constant supervision, work on single phase, energized conductors up to 15 KV. All aerial work in this classification is performed under the close and/or constant supervision of a qualified line worker. Employees are expected to show proficiency in the Line Worker Apprentice requirements set forth below before being allowed to advance to the Line Worker (+) classification.

	Work Description	Not Exposed	Continue to Develop	Proficient	Notes
Safety	Demonstrates a working knowledge and understanding of all safety rules and Company work procedures applicable to the Line Worker Apprentice Classification.				
Safe Work Practices	Demonstrates a working knowledge of the Company's T&D Standards applicable to job duties, i.e., Construction and Electrical Service Requirements.				
	Completion of Switching and Tagging School.				
	Demonstrates an operational understanding of the following line devices: Reclosers, Air-Break Switches, Sectionalizers, Capacitors and Regulators.				
De-energized Work (Single Phase)	Under <u>close</u> supervision, tests for voltage, installs and removes personal protective grounds on single phase primary lines.				
	Working with a qualified line worker, participates in storm restoration activities.				

Energized Single Phase Secondary Work	First in training and then under the direction and <u>close</u> supervision of a qualified line worker, connects secondary services to transformers on single-phase distribution circuits, providing “MAD” zone clearances can be maintained.				
	Works on single phase, energized conductors up to 750 volts, first in training and then under <u>close</u> supervision in the field, providing “MAD” zone clearances can be maintained.				
	Under <u>close</u> supervision, installs, removes and re-lamps street lighting equipment.				
	Assists in the installation of single-phase URD services, i.e., cable installation / terminations / elbows / protective devices.				
Energized Single Phase Primary Work	In the second 6 months, first in training and then under <u>constant</u> supervision, performs work with rubber gloves on single phase, energized primary circuits up to 15KV.				
	Under <u>close</u> supervision of a qualified line worker, demonstrates proficiency in connecting and disconnecting single phase primary lines by means of switches or fused cutouts.				
	Performs single phase switching procedures under the direction and <u>close</u> supervision of a Qualified Tag Holder.				
Meter Work	After demonstrating a thorough understanding of all the tests and practices associated with setting and removing single phase meters, first in training then supervised in the field, and providing no unsafe conditions exist, a LWA may perform this work in an unsupervised environment at any time during this step and hereafter.				
Personal Accountability	Demonstrates a Positive Work Attitude on a Daily Basis.				

	Attendance is Satisfactory.				
	Is current with Apprenticeship Training Requirements				

Notes / Comments:

Signatures of Line Supervisor and Technical Trainer Performing Assessment:

_____ Date ___/___/___

_____ Date ___/___/___

Versant Power
LINE WORKER PROGRESSION EVALUATION

LINE WORKER APPRENTICE (+)

EMPLOYEE _____

DIVISION / DEPARTMENT ____/____

CURRENT CLASSIFICATION _____

Classification Overview: The Line Worker Apprentice (+) classification introduces the employee to more advanced aerial live line work activity. Employees are expected to show proficiency in the Line Worker Apprentice (+) requirements set forth below before being allowed to advance to the Line Worker 2nd Class rating.

	Work Description	Not Exposed	Continue to Develop	Proficient	Notes
Safety	Demonstrates a working knowledge and understanding of all safety rules and Company work procedures applicable to the Line Worker Apprentice (+) Classification.				
Safe Work Practices	Demonstrates a working knowledge of the Company's T&D Standards.				
	Completion of Switching and Tagging School (if not previously attended)				
	Demonstrates an operational understanding of the following line devices: Reclosers, Air-Break Switches, Sectionalizers, Capacitors, Regulators.				
	Demonstrates ability to read and understand System Diagram. Is familiar with Transmission and Distribution system in his division.				
	Is currently up-to-date on the following certifications and training requirements: Pole Top / Bucket Rescue; CPR / First Aid; Forklift; Environmental.				
De-energized Work (Single/Multi- Phase)	Demonstrates a working knowledge of personal protective grounding for work on single and multi-phase de-energized circuits.				
	Demonstrates the ability to safely install, remove and re-lamp street lighting equipment.				

Energized Single/Multi- Phase Secondary Work	Demonstrates the ability to safely connect secondary services up to 750 volts to pole-mounted transformers alone including energizing the transformer with the appropriate hot stick (clearance from the MAD must be maintained).				
Energized Single Phase Primary Work	Under <u>close</u> supervision demonstrates the ability to work safely with rubber gloves on single phase circuits energized up to 15KV.				
	Demonstrates the ability to install single phase URD cable and prepare elbows, terminations and protective devices.				
	Using hot line tools, demonstrates the ability to safely energize and de-energize single phase primary lines, transformers, and other related line devices.				
	Actively participates in storm restoration work.				
Energized Multi-Phase Primary Work	Performs single and multi-phase Switching Procedures under the direction and <u>close</u> supervision of a Qualified Tag Holder				
Energized Transmission Work	Introduction to energized transmission work				
Meter Work	Demonstrates understanding of the Company's <i>Requirements for Electric Service Installations</i> , can safely set single and mutli-phase self-contained meters.				
Personal Accountability	Demonstrates a positive work attitude on a daily basis				
	Attendance is satisfactory				
	Is current with Apprenticeship Training Requirements				

Notes / Comments:

Signatures of Line Supervisor and Technical Trainer Performing Assessment:

_____ **Date** ____/____/____

_____ **Date** ____/____/____

Versant Power
LINE WORKER PROGRESSION EVALUATION

LINE WORKER 2nd CLASS

EMPLOYEE _____

DIVISION / DEPARTMENT ____/____

CURRENT CLASSIFICATION _____

Classification Overview: The Line Worker 2nd Class classification introduces the employee to more advanced aerial live line work activity, to include working on energized 3-phase circuits. Employees are expected to show proficiency in the Line Worker 2nd Class requirements set forth below before being allowed to advance to the Line Worker 2nd Class (+) classification.

	Work Description	Not Exposed	Continue to Develop	Proficient	Notes
Safety	Demonstrates a working knowledge and understanding of all safety rules and Company work procedures applicable to the Line Worker 2 nd Class position.				
Safe Work Practices	Demonstrates a working knowledge and understanding of the Company's T&D Standards applicable to job duties, i.e. Construction & Electrical Service Requirements.				
	Demonstrates the ability to troubleshoot distribution problems on single-phase and multi-phase circuits.				
	Familiar with how to read a System Diagram.				
De-energized Work	Demonstrates a working knowledge of the Company's protective grounding requirements.				
Energized Single Phase Primary Work	Works on Single-Phase energized conductors with rubber gloves, under <u>close</u> supervision, on circuits up to 15KV.				
Energized Multi-Phase Primary Work	In the first six months, first in training and then under <u>constant</u> supervision of a qualified line worker, works with rubber gloves on energized multi-phase circuits up to 15KV.				

	In the second six months, first in training and then under <u>close</u> supervision of a qualified line worker, works with rubber gloves on energized multi-phase circuits up to 15KV.				
	Demonstrates familiarity with the installation and troubleshooting of single- and multi-phase URD systems.				
	Performs switching procedures under the <u>close</u> supervision of a Qualified Tag Holder.				
Energized Transmission Work	Under <u>constant</u> supervision, assists qualified line workers in performing work on transmission systems, energized and de-energized.				
Personal Accountability	Demonstrates a positive work attitude on a daily basis				
	Attendance is satisfactory				
	Is current with Apprenticeship Training Requirements				

Notes / Comments:

Signatures of Line Supervisor and Technical Trainer Performing Assessment:

_____ Date ____/____/____

_____ Date ____/____/____

Versant Power
LINE WORKER PROGRESSION EVALUATION

LINE WORKER 2nd CLASS (+)

EMPLOYEE _____

DIVISION / DEPARTMENT ____ / ____

CURRENT CLASSIFICATION _____

Classification Overview: The Line Worker 2nd Class (+) classification introduces the employee to more advanced aerial live line work activity, to include advanced trouble-shooting and working (under limited supervision) with rubber gloves on energized 3-phase conductors up to the 15KV level. Employees are expected to show proficiency in the work requirements set forth below before being allowed to advance to the Line Worker First Class rating.

	Work Description	Not Exposed	Continue to Develop	Proficient	Notes
Safety	Demonstrates a working knowledge and understanding of all applicable safety rules and Company work procedures specific to the Transmission and Distribution function.				
Safe Work Practices	Demonstrates a working knowledge and understanding of the Company's T&D Standards, including single-phase and multi-phase URD systems.				
	Can read and understand the System Diagram. Is familiar with, and has a working knowledge of, the transmission and distribution system in his area.				
	Can safely and effectively operate equipment necessary for the construction, operation and maintenance of the T&D system (Exclusive of off-road equipment, i.e., Nordwell & Terex)				
	Demonstrates a thorough knowledge and understanding of the Company's Switching and Tagging Rules and the ability to safely perform switching and tagging procedures under the <u>close</u> supervision of a Qualified Tag Holder.				

Energized Work	Demonstrates the ability to work safely with rubber gloves on circuits energized up to the 15KV level.				
	Demonstrates the ability to safely install, remove and troubleshoot single-phase and multi-phase transformer installations.				
	Demonstrates the ability to safely and effectively perform troubleshooting on single-phase and multi-phase overhead transmission and distribution circuits.				
	Demonstrates the ability to safely and effectively perform troubleshooting on single-phase and multi-phase URD systems, both primary and secondary.				
	Demonstrates the ability to install, remove, and troubleshoot all line devices to include reclosers, air-break switches, sectionalizers, voltage regulators, lightning arrestors and capacitors.				
	Demonstrates the ability to work safely with hot stick equipment on transmission circuits.				
Personal Accountability	Demonstrates a positive work attitude on a daily basis.				
	Attendance is satisfactory.				
	Is current with Apprenticeship Training Requirements.				

Notes / Comments:

Signatures of Line Supervisor and Technical Trainer Performing Assessment:

_____ Date ____/____/____

_____ Date ____/____/____

Matrix

	Ground Worker	Apprentice	Apprentice (+)	Second	Second (+)
Meter Set					
Single-Phase Meter Set	X	X	X	X	X
Three-Phase Meter Set			X	X	X
Grounds					
De-energized Secondaries and Grounded Primaries	X	X	X	X	X
Grounded Transmission	X	X	X	X	X
Install Grounds Single-Phase		X	X	X	X
Install Grounds Three-Phase			X	X	X
Secondary					
Single-Phase Secondary (close)		X			
Single-Phase Secondary (unsupervised)			X	X	X
Three-Phase Secondary (close)			X		
Three-Phase Secondary (unsupervised)				X	X
Primary					
Single-Phase Primary (constant)		2 nd 6 mos.			
Single-Phase Primary (close)			X	X	
Single-Phase Primary (limited)					X
Energize Single-Phase Transformers (unsupervised)			X	X	X
Three-Phase Primary (constant)				1 st 6 mos.	
Three-Phase Primary (close)				2 nd 6 mos.	
Three-Phase Primary (limited)					X
Energize Three-Phase Transformers (unsupervised)				X	X
Transmission					
Energized Transmission (constant)				X	
Energized Transmission (close)					X
Switching					
Single-Phase (close)		X	X	X	X
Three-Phase (close)			X	X	X
Transmission (close)				X	X

Entry Classification Guidelines for Internal Line Worker Applicants**(Exceptions to the following criteria are at management discretion)**

- 1.) Power System Technical 1st Class and above will enter at the Line Worker Apprentice classification. They can perform switching under limited supervision but can't hold a tag until they attain the rating of 1st Class Line Worker.
- 2.) All other internal transfers will start at the Ground Worker classification.

Entry Classification Guidelines for External Line Worker Applicants**(Exceptions to the following criteria are at management discretion)**

- 1.) No Line Worker training/experience - Entry classification will be Ground Worker
- 2.) Possesses certificate from an approved Line Worker training program – Starts at the Apprentice classification.
- 3.) Possesses certificate plus a minimum of one year line experience – Starts at the Apprentice Plus classification
- 4.) Possesses certificate plus has attained a rating of 1st Class Line Worker – Starts at the Apprentice Plus classification.

Apprentice Call Duty

- 1.) Personnel in the NOR must be 1st Class to take call duty
- 2.) New hires in the SOR - Call duty after 6 months of hire date
- 3.) Personnel that transfer NOR to SOR – Call duty 3 months from transfer date
- 4.) Personnel that transfer from one district in the SOR to another SOR district - Call duty immediately

Revision Page**8/25/2015 Original document**

11/6/2015 Original document stated that Line Worker Apprentice could work under constant and close supervision on three phase equipment. This was inconsistent with the Safety manual. Changed it in this revision to “*Under constant supervision, performs work with rubber gloves on single phase, energized primary circuits up to 15KV.*” – Brian Gould, Brad Flannery

6/15/2016 Added the following wording to the original document:

- 1. Cover Page: With the exception of Ground Worker, being six months, normal time spent in each classification will be twelve months. 12 months as a Line Worker 2nd Class(+) is mandatory with any exceptions being approved by Line and Safety Department managers. Attitude, safety, attention to detail, in the classroom and in the field, will be considered in addition to actual job performance in the company’s decision to advance an employee to the next step in this progression. Inadequate performance in any area may be basis for additional time spent in any level of progression. When a Line Apprentice has successfully completed a level of their progression training in the field and in the classroom, they can perform all duties within that level in an unsupervised environment, providing they meet the “Working Alone” criteria in section 5.2 of the Emera Maine Safety Manual.**
- 2. Ground Worker: Ground Workers are prohibited from working on energized conductors or conductors that could become energized at any voltage.**
- 3. Line Worker Apprentice: As a LWA, the employee will begin to gain experience around energized equipment and may in the first 6 months, first accompanied by in training and then under Close supervision in the field, work on single phase, energized conductors up to 750 volts. During the second 6 months, the LWA may, first accompanied by in training and then under Constant supervision, work on single phase, energized conductors up to 15 KV.**
- 4. LWA Line 3: Under close supervision of a qualified line worker, demonstrates proficiency in connecting and disconnecting single phase primary lines by means of switches or fused cutouts.**
- 5. LWA Line6: In the second 6 months, first in training and then under constant supervision, performs work with rubber gloves on single phase, energized primary circuits up to 15KV.**
- 6. LWA Line 9: Works on single phase, energized conductors up to 750 volts, first in training and then under close supervision in the field, providing “MAD” zone clearances can be maintained.**
- 7. LWA Line 13: After demonstrating a thorough understanding of all the tests and practices associated with setting and removing single phase meters, first in training then supervised in the field, and providing no unsafe conditions exist, a LWA may perform this work in an unsupervised environment at any time during this step and hereafter.**
- 8. 2nd Class Lines 7 and 8: In the first six months, first in training and then under constant supervision of a qualified line worker, works with rubber gloves on energized 3-phase circuits up to 15KV. In the second six months, first in training and then under close supervision of a qualified line worker, works with rubber gloves on energized 3-phase circuits up to 15KV. – Brian Gould, Brad Flannery and supported by the Line Progression Document Team**

10/11/2017 Original document reformatted

10/11/2017 Added the following wording to the document:

- 1. Line Worker Apprentice (+): Demonstrates the ability to safely connect secondary services up to 750 volts to pole-mounted transformers.**
- 2. LWA (+): Demonstrates a working knowledge of personal protective grounding for work on single and three-phase de-energized circuits.**
- 3. LWA (+): Performs single and three-phase Switching Procedures under the direction and close supervision of a qualified Line Worker.**
- 4. LWA (+): Demonstrates understanding of the Company's *Requirements for Electric Service Installations*, can safely set single and three-phase self-contained meters.**

10/11/2017 Addition of Matrix sheet

11/13/2017 Added the following wording to the document:

- 1) Personnel in the NOR must be 1st Class to take call duty**
- 2) New Hires in the SOR- Call duty after 6 months of hire date**
- 3) Personnel that transfer NOR to SOR- Call duty 3 months after transfer**
- 4) Personnel that transfer from one district in the SOR to another SOR district- Call duty immediately**

12/19/2017 Changed wording of 3-phase to multi-phase to include 2-phase installations - Brian Gould/Brad Flannery/Leadership Team

8/15/2018 Added wording to page 3 for supervision of setting poles in energized conductors - Brian Gould/Brad Flannery/Leadership Team

3/5/2019 Amended matrix to coincide with language of progression document concerning limited supervision for Second (+) primary work – Brian Gould

6/29/2020 Convert to Versant Power – Brian Gould

9/11/2020 Added Qualified Tag Holder/Line Supervisor direction to the definitions page 3.

Changed Line Worker to Tag holder in the Switching Procedures Section of Apprentice thru Second (+) - Brian Gould

Section 5	Transmission and Distribution	
5.2	Working Alone	Effective Date: 1/1/2016 Revised: 2/28/2021
5.2.1 Purpose	Employees working alone may be exposed to significantly more risk than employees working with others. Therefore, this section provides safe work practices for T&D employees when they are working alone.	
5.2.2 Responsibilities	<ol style="list-style-type: none"> 1. The Company is responsible for ensuring that only trained and qualified employees work alone on the T&D system. 2. The supervisor is responsible for ensuring that the employee is not being asked to do an unsafe task. 3. The supervisor is responsible for ensuring that the employee is comfortable completing the task at hand. 4. Employees are responsible for informing their supervisor if they are uncomfortable with performing any tasks they are given. 5. Employees are responsible for fully assessing work place conditions for potential hazards prior to starting any work and for following safe work practices while working alone. 6. Employees are responsible for asking for assistance if, in their judgment, the task can't be safely performed alone. 	
5.2.3 Requirements	<ol style="list-style-type: none"> 1. Proper Qualifications 	
5.2.4 Risk Identification	<ol style="list-style-type: none"> 1. Increased risk of personal injury caused by working alone. 2. Increased potential for equipment damage due to not having a spotter available. 3. Serious injury caused by electrical contact. 	
5.2.5 Safe Work Procedures	<ol style="list-style-type: none"> 1. Line Worker Working Alone <ol style="list-style-type: none"> a. A 1st Class line worker shall be considered alone unless accompanied by an employee trained in bucket rescue and/or pole top rescue, or is accompanied by a qualified PST worker. Refer to Attachment A. b. A line worker working alone shall not: <ol style="list-style-type: none"> i. Perform rubber glove work on energized primary lines. ii. Climb poles. iii. Set poles. iv. Install, remove or repair energized primary lines. v. Install, remove or repair de-energized lines if contact with energized primary lines is possible. vi. Install, remove or repair equipment if contact with energized primary lines is possible. vii. Operate a gas powered chain saw where contact with energized primary lines is possible. viii. Perform isolated not grounded work (ING) per SWP 5.22 ix. Perform other work of equal or greater hazard than those listed above. 	

	<ul style="list-style-type: none"> c. A line worker working alone can: <ul style="list-style-type: none"> i. Work out of an insulated aerial lift. ii. Perform work with hot-line tools outside the MAD zone. Refer to Section 5.4 Minimum Approach Distances. iii. Cut an energized line with insulated tools to protect the public. iv. Open and close primary cutout fuses. v. Replace primary cutout fuses. vi. Perform switching operations. Refer to Section 6 Switching and Tagging. vii. Use a chain saw to remove trees from de-energized lines that are red tagged, tested and grounded, provided the task can be done safely and the employee is not in the fall zone. d. A line worker working alone can perform the permitted tasks at night or in inclement weather if the task can be performed safely. e. A line worker shall request assistance if the task has been determined unsafe or beyond their ability to safely perform alone. f. A line worker working alone is required to have a bucket self-rescue device in the bucket before the boom leaves the cradle. <p>2. Power Systems Technical (PST) Worker Working Alone</p> <ul style="list-style-type: none"> a. A qualified PST worker working alone shall be permitted to: <ul style="list-style-type: none"> i. Troubleshoot initial calls from System Operations. ii. Perform basic tasks inside a substation control house. iii. Perform switching tasks. b. A PST worker working alone can perform the permitted tasks at night or in inclement weather if the task can be performed safely. c. A PST worker shall request assistance if the task has been determined unsafe or beyond their ability to perform safely alone.
<p>5.2.6 Definitions</p>	<p>MAD : Minimum Approach Distance</p> <p>Qualified: a person who, by possession of a recognized degree, certificate, or professional standing, or who by extensive knowledge, training and experience, successfully demonstrates the ability to solve problems relating to the subject matter, the work or the project.</p> <p>Isolated Not Grounded (ING): This refers to primary electrical conductors that have been disconnected from energy source(s) via open switch, breaker, disconnect, etc. but NOT grounded. ING Safe Work Practices are detailed in SWP 5.22. Key to SWP 5.22 is understanding that any primary ungrounded conductor must be considered energized and all energized work rules apply. Additionally, any work done on ING primary conductors requires a red tag zone of protection be established.</p>



FLEXIBLE WORK ROLES FOR QUALIFIED POWER SYSTEM TECHNICIANS

Definition: **Qualified Technician** = An employee of the Power System Technical Department classified as Power Technician Apprentice (Equivalent or Greater), and has been trained in Bucket Control, Bucket Self-Rescue, First Aid, CPR, Switching & Tagging, and has attained a Class “B” CDL license.

Qualified Technicians may perform the following task(s) with a (Power Technician or Line Worker that has attained a rating of 1st Class or greater, and has been trained in the following, and under the close supervision of the 1st Class worker on site):

1. Perform switching and tagging procedures without restrictions.
2. Staff major substations.
3. Damage Assessing.
4. Perform Ground Worker duties while working with a line crew.
5. Assume “second seat” on a bucket truck. Line worker is restricted from pole climbing activities, and must adhere to Section **5.2.5 1** of safety manual “Lineworker Working Alone”.
6. Repair / Tap-on service entrance conductors (<600V) on the customer premises.
7. A qualified Technician may perform the following tasks from an aerial lift device:
 - Tag appropriately, test for absence of voltage and install personal protective grounds on 3-phase and single-phase circuits.
 - With approved hot sticks, open and close line protective devices.
 - Work on secondary conductors (<600V) attached to the pole provided clearance from the Minimum Approach Distance “MAD” zone can be established / maintained. If necessary, may install rubber cover-up on secondary / neutral conductors or hard cover-up on primary conductors with an approved hot stick device.
 - With approved hot stick device, may untap transformers in order to provide working clearance from the Minimum Approach Distance “MAD” zone.
 - Remove trees, repair downed conductor on primary lines provided line is properly grounded and safe for such work to be performed.
 - Remove trees, repair downed conductor on energized secondary lines, (<600V) with an approved hot stick device / hydraulic pole saw that has been properly tested, with appropriate work clearances from primary lines.
 - Remove branches or small limbs on energized primary lines with an approved hot stick device/ hydraulic pole saw that has been properly tested, with appropriate work clearances from other energized sources or paths to ground.

Section 5	Transmission and Distribution	
5.3	Arc Flash	Effective Date: 4/1/2015 Revised: 9/1/2019
5.3.1 Purpose	This section covers the workplace practices and use of “AR” (Arc Rated) protective clothing and equipment when employees are exposed to the hazards associated with flames and electrical arc flash.	
5.3.2 Responsibilities	<p>1. Application</p> <p>a. All persons performing work that exposes them to an arc flash hazard within an arc flash boundary shall wear approved AR (Arc Rated) clothing or clothing system and use other protective equipment with an arc rating greater than or equal to the heat energy they are exposed to as described in Section 5.3.4. All persons performing work that exposes them to an open flame hazard shall wear approved FR (Flame Resistant) clothing and other protective equipment.</p> <p>i. Examples requiring AR protective clothing and equipment include:</p> <ul style="list-style-type: none"> ➤ entry into an arc flash boundary of exposed energized parts ➤ performing any function outside of normal operating conditions that constitutes interaction with energized equipment that may result in an arc flash hazard ➤ exposure to contact with energized parts ➤ the use of rubber gloves, insulated sticks, or switching activity <p>ii. The use of welders, grinders, torches, or open flames require the wearing of FR protective clothing and equipment.</p> <p>b. Employees shall report to work with base AR clothing for rating of ARC 2 – see 5.3.2 3 below. Base AR clothing (ARC 2) must be worn if you are inside the Arc Flash Boundary until an EPZ has been established OR during work requiring rubber gloves or switching activities.</p> <p>2. Proper Wearing of AR clothing when inside the Arc Flash Boundary:</p> <ul style="list-style-type: none"> a. Shirts may be worn tucked in or over pants b. Shirt Sleeves rolled down and buttoned unless tucked into rubber gloves or sleeves c. Shirt buttoned to but not including the top collar button. d. Pockets do not need to be fastened closed. e. Excluding a-d above - All zippers zipped, buttons buttoned, Velcro fastened, etc, f. AR Clothing needs to be clean, free from contaminants g. Must fit well with some looseness to provide air gap which improves performance in reducing exposure to heat. <p>3. AR clothing and undergarments worn under AR clothing</p> <p>a. Base AR clothing for standard daily wear shall be a minimum rating of</p>	

	<p>ARC 2 (Minimum 8 calorie/cm²) and consist of long pants and long sleeve shirt.</p> <ul style="list-style-type: none"> b. If worn, undergarments (if non AR) shall be light in color and 100% natural fiber, such as 100% cotton, wool or silk or AR rated in any available color and be worn underneath AR clothing. Non AR shirts cannot have labels or decals that compromise the 100% natural requirements. AR shirts cannot be modified from original manufacturer design. c. ARC 2 or greater shirts, or similar items, do not require the wearing of undergarments d. Clothing made from acetate, nylon, polyester, or polypropylene shall not be worn either alone or in blends. <p>4. Outermost layers</p> <ul style="list-style-type: none"> a. Traffic safety vests, rain suits and any other wear that makes up the outermost protective layer shall be AR. <p>5. Contractors</p> <ul style="list-style-type: none"> a. Contractors shall wear AR protective clothing and equipment as specified in this section of the Company's Safety Manual.
<p>5.3.3 Requirements</p>	<ul style="list-style-type: none"> 1. Minimum AR pants and shirts (8 Cal Shirt, 8 & 20 Cal pants) 2. 20 Cal Face Shield 3. 20 Cal Balaclava 4. Minimum 20 Cal Clothing system to meet ARC-3 5. 40 calorie suit, as specified for metal clad switchgear 6. Protective Rubber Goods 7. Insulated Stick 8. PPE including: Hard Hat, Safety Glasses, AR Hearing Protection, Rubber Gloves with Leather Protectors, Heavy-Duty Leather Gloves (min weight 12 oz/yd²), Heavy-Duty over the Ankle Work Boots 9. Undergarments as described in section 5.3.2.b & c above
<p>5.3.4 Risk Identification</p>	<p>1. General – Risk</p> <ul style="list-style-type: none"> a. AR clothing and AR equipment used as PPE: <ul style="list-style-type: none"> i. Arc flash hazards should be eliminated whenever it is practical to do so. ii. Ratings of AR protective wear are intended to minimize an arc flash burn to a 50% probability of the onset of a second degree burn. b. Required PPE by ARC Levels: <ul style="list-style-type: none"> i. The required PPE for Arc Flash Protection will fall under 1 of 4 ARC categories defined by the level of Incident Energy Exposure, (also refer to Appendix A). ii. The following table outlines those requirements:

Versant Power Arc Rating PPE levels

AR Category	Cal/Cm ² Rar	Required PPE
ARC1 (Base PPE)	0.0 - 5.0	AR8 Cal Long Sleeve Shirt and Pants. T-Shirt or other Non-AR Undergarments are not required but if worn must be light in color, 100% natural Fiber Cotton, wool, or silk and have no stickers or decals. AR undergarments shall not be altered. Hard Hat, Safety Glasses, Rubber Gloves with Leather Protectors when needed or Heavy Duty (=> 12 oz/yd ²) or AR Leather Gloves. Heavy duty over the ankle footwear. Additional outer layers (Jacket, Parka, Rainwear or Hard Hat Liners must be AR).
ARC2	5.0 - 8.0	Same as ARC1
ARC3	8.0 - 20.0	AR20 Cal Clothing System or Lab Coat, all else the same.
ARC4	20.0 - 40.0	AR40 Cal Suit Including 40 Cal Hood, all else same.
Head and face Protection		Suffix F = AR20 Cal Faceshield Suffix B = AR20 Cal Balaclava
<i>Examples</i>	ARC2 - F ARC3 - FB	ARC2 PPE required + Faceshield ARC3 PPE required + Faceshield + Balaclava

2. T&D Substations (2.4kv – 345 kv)

- a. Arc Flash Boundary:
 - i. The arc flash boundary for all substations is 6 feet from any exposed energized equipment.
- b. ARC PPE Level:
 - i. ARC-2 for all energized stick work.
 - ii. For any work requiring direct contact with rubber gloves, engineering shall be consulted to determine the specific IE (Incident Energy) at a distance of 15 inches.
- c. Exceptions:
 - i. Orrington and Eastern Ave.
Arc Flash Boundary = 9 feet.
 - ii. Grant Street 2.4 Kv Substation
Arc Flash Boundary = 14 feet.

3. T&D Overhead Lines (2.4kv – 345 kv)

- a. Arc Flash Boundary:

- i. The arc flash boundary for all T&D Lines will be equal to the applicable MAD (Minimum Approach Distance) for the nominal voltage of the Line.
- b. ARC PPE Level:
 - i. ARC-2 for all stick and rubber glove work.
- c. Exceptions:
 - i. None.

4. Metal Clad Breakers – (Arc In A Box)

- a. Arc Flash Boundary:
 - i. The arc flash boundary for all metal clads is anywhere within the metal clad unit. For open rooms (Park Street and etc.), anywhere in the room, for outdoor units 40 feet.
- b. ARC PPE Level:
 - i. ARC-4
- c. Exceptions:
 - i. Eastport T1L - Scada operate remotely, de-energize for anything beyond until engineered out.
 - ii. ARC-2 PPE level is acceptable inside metal clad unit if no switching is occurring and no equipment is exposed (doors closed) for brief inspections, meter reading.

5. Meters - (Arc In A Box)

- a. Arc Flash Boundary:
 - i. The arc flash boundary for all meters is 6 feet.
- b. ARC PPE Level:
 - i. ARC-2F
- c. Exceptions:
 - i. 480 Volt Series Connected ARC-3FB
 - ii. Transformer Rated Meters (any voltage) ARC-2

6. Padmount Transformers including secondary cabinets and pedestals - (Arc In A Box)

- a. Arc Flash Boundary:
 - i. The arc flash boundary for all Pad Mount Transformers including secondary cabinets and pedestals is 6 feet.
- b. ARC PPE Level:
 - i. ARC-2F
- c. Exceptions:
 - i. Distribution and Substation 480 Volt ARC-3FB
 - ii. AMR XFMR Secondary Cabinets Arc Flash Boundary = 13 Feet, ARC-4 or De-energize.

7. OMU Cabinets – 480 Volt

- a. Arc Flash Boundary:
 - i. The arc flash boundary for OMU cabinets is 6 feet.
- b. ARC PPE Level:
 - i. ARC-2F
- c. Exceptions:
 - i. None.

	<p>8. Underground Systems - (Arc In A Box) Manhole Underground Systems: examples: City of Bangor and Loring</p> <ul style="list-style-type: none"> a. Arc Flash Boundary: <ul style="list-style-type: none"> i. The arc flash boundary for all underground in this category is within any enclosed area with energized equipment including vaults, manholes and etc. and 6 feet when in open space (above grade switch enclosures, etc.). b. ARC PPE Level: <ul style="list-style-type: none"> i. ARC-2 c. Exceptions: <ul style="list-style-type: none"> i. Any activity involving work with exposed energized conductors or equipment or the operation or switching of equipment ARC – 3FB. <p>9. URD - Underground Residential Distribution</p> <ul style="list-style-type: none"> a. Arc Flash Boundary: <ul style="list-style-type: none"> i. The arc flash boundary for all underground in this category is within any enclosed area including vaults, manholes and etc. and 6 feet when in open space (above grade switch enclosures and etc.). b. ARC PPE Level: <ul style="list-style-type: none"> i. ARC-2 c. Exceptions: <ul style="list-style-type: none"> i. Any activity involving work with exposed energized conductor or equipment. ARC – 3FB <p>10. Distribution Panels - (Arc In A Box)</p> <ul style="list-style-type: none"> a. For the purpose of this section, electrical panel boards that are not locked out and tested as being de-energized shall be considered energized. <ul style="list-style-type: none"> i. All work in “AC” panel boards should be performed with the panel board de-energized unless the company can demonstrate that de-energizing introduces additional or increased hazards or that performing de-energized work is not feasible due to equipment design or operational limitations. b. Persons performing work in energized panel boards shall be protected as follows: <ul style="list-style-type: none"> i. Arc Flash Boundary: <ul style="list-style-type: none"> 1. The arc flash boundary for panel boards is 7 feet. ii. ARC PPE Level: <ul style="list-style-type: none"> 1. ARC-2F iii. Exceptions: <ul style="list-style-type: none"> 1. >= 480 volts ARC–3FB 2. Arc flash boundary for 480 volts panels is 10 feet.
<p>5.3.5 Safety Procedures</p>	<p>1. AR Clothing Care and Maintenance</p> <ul style="list-style-type: none"> a. Inspection: AR clothing and equipment shall be inspected prior to use. <ul style="list-style-type: none"> i. Inspection Criteria: <ul style="list-style-type: none"> 1. AR clothing and equipment shall be inspected to verify all buttons, zippers, velcro or other attachment devices

	<p>are properly attached and are functional.</p> <ol style="list-style-type: none"> 2. AR clothing shall be removed from service when the fabric is frayed on cuffs, collars, hoods, elbows and etc. is identified. <ol style="list-style-type: none"> a. The wearing of altered AR clothing, such as AR shirts with the sleeves cut off is <u>prohibited</u>. 3. AR clothing shall not contain rips or tears unless properly repaired by the clothing vendor using approved methods. <ol style="list-style-type: none"> a. Employees shall not repair AR clothing for rips, tears, missing buttons or similar defects. 4. AR equipment shall be removed from service if cracks, gouges or other signs of damage are identified. <p>b. Self-Washing Criteria:</p> <ol style="list-style-type: none"> i. Employees are to follow the guidance provided by the manufacturer for the type of AR fabric that their clothing is made from. ii. Do not: <ol style="list-style-type: none"> 1. use water over 140 degrees F. 2. launder with non-AR clothing. 3. use tallow soap, bleach, fabric softener, or hydrogen peroxide to launder AR clothing. iii. Leased clothing should be washed by the leasing vendor. <p>c. Insect Repellent use on AR protective clothing or equipment:</p> <ol style="list-style-type: none"> i. Only Rainbow 4507 or 4509 Tick & Mosquito Repellent is approved for use on AR protective clothing and equipment. <ol style="list-style-type: none"> 1. Other repellents shall require the Safety Department's approval and shall be issued as an addendum to this section once approved. ii. Insect repellents containing DEET are permitted for use on the skin only and shall NOT be used on AR protective clothing.
<p>5.3.6 Definitions</p>	<p>ARC: Versant Power Arc Rating Categories.</p> <p>ARC-1 0 – 5.0 Calories/CM²</p> <p>ARC-2 5.001-8.0 Calories/CM²</p> <p>ARC-3 8.001-20.0 Calories/CM²</p> <p>ARC-4 20.001-40.0 Calories/CM²</p> <p>Suffix – F Requires 20 Calorie Face shield</p> <p>Suffix – B Requires 20 Calorie Balaclava</p> <p>Arc Flash: a rapid, explosive discharge of electrical energy that usually results from a short circuit. Short circuits are caused by flashover of electric current through air between live parts or from live parts to ground. Dielectric of air: (1 inch = 10 Kv).</p> <p>Arc Flash Boundary: if an arc flash occurred, this boundary is where an employee would be exposed to a curable second degree burn (IE of 1.2 calories/cm²). Note:</p>

The Arc Flash Boundary that will be used for T&D Lines will be equivalent to the applicable MAD (Minimum Approach Distance) as calculated by Engineering for the nominal voltage of the specific Line. At the MAD for T&D Lines, the IE will be no greater than 2 calories/cm².

Arc Flash Hazard: the danger of excessive heat exposure and serious burn injury due to arcing faults in electrical power systems. Note: An arc flash hazard may exist when energized electrical conductors or circuit parts are exposed or when they are within equipment in a guarded or enclosed condition, provided a person is interacting with the equipment in such a manner that could cause an electric arc. Under normal operating conditions, enclosed energized equipment that has been properly installed and maintained is not likely to pose an arc flash hazard.

Arc Flash Hazard Assessment: a study investigating a worker's potential exposure to arc-flash energy, conducted for the purpose of injury prevention and the determination of safe work practices and the appropriate levels of PPE.

Arc Rating (AR): the value attributed to materials that describe their performance to exposure to an electric arc discharge. The arc rating is expressed in cal/cm² and is derived from the determined value of the arc thermal performance value (ATPV) or break open threshold (EBT) in the event the material exhibits a break open response at a value below the ATPV value.

Arc Thermal Performance Value (ATPV): the incident energy on a material or multilayer system of material that results in a 50% probability that sufficient heat transfer through the material is predicted to cause the onset of a second degree skin burn injury. **Used in conjunction with break open threshold (EBT) to derive Arc Rating (AR) Cal/Cm² of material.**

Energy Break Open Threshold (EBT): the highest incident energy exposure value on a fabric where the garments do not exhibit break-open which is the formation of holes in the fabric that would allow heat or flames to pass through.

Calorie: the amount of heat it takes to raise one gram of water one degree centigrade at one atmosphere of pressure. If you hold a lighter under your skin for one second, you will experience 1 calorie of heat.

Incident Energy: the total amount of heat energy (per unit area) impressed (Incident) on a surface, a certain distance from the source. Measured in Calories/Square Centimeter. Cal/CM². Level varies inversely with the square of the distance between the employee and the source of the Arc (double distance = quarter energy, visa versa)

Exposed: capable of being inadvertently touched or approached nearer than a safe distance by a person.

Electrical Panel Boards the electrical AC panels located at the Company's facilities and in substation control houses or any other junction box or enclosure that we own that houses one.

Flame Resistant: the characteristic of a fabric to resist ignition and to self-extinguish if ignited

Minimum Approach Distance: the closest distance a qualified employee is permitted to approach either an energized or grounded object (the grounded object applies to live line work), as applicable for the work method being used.

Minimum Approach Distances (MADs)

Nominal Voltage (kV)-

Phase - Phase	Distance (ph - gr exposure)		Distance (ph - ph exposure)	
	ft	inches	ft	inches
	0.050 - 0.300	Avoid contact		Avoid contact
0.301 - 0.750	1.09	14	1.09	14
0.751 - 5.0	2.07	25	2.07	25
5.1 - 15.0	2.14	26	2.24	27
15.1 - 36.0	2.53	31	2.92	36
36.1 - 46.0	2.76	34	3.22	39
46.1 - 72.5	3.29	40	3.94	48

Nominal Voltage (kV)-

Phase - Phase	Distance (ph - gr exposure)		Distance (ph - ph exposure*)	
	ft	inches	ft	inches
	72.5 - 121.0	3.71	45	4.66
121.1 - 145.0	4.27	52	5.38	65
145.1 - 169.0	4.79	58	6.36	77
169.1 - 242.0	6.59	80	10.1	122
242.1 - 362.0	11.19	135	18.11	218
362.1 - 420.0	13.94	168	22.34	269
420.1 - 550.0	16.63	200	27.03	325
550.1 - 800.0	22.57	271	37.34	449

**-Provided no insulated tool spans the gap and no large conductive object is in gap*

ARC Flash Requirements PPE Requirements by ARC Level

Versant Power Arc Rating PPE levels		
AR Category	Cal/Cm ² Range	Required PPE
ARC1 (Base PPE)	0.0 - 5.0	AR8 Cal Long Sleeve Shirt and Pants. T-Shirt or other Non AR Undergarments are not required but if worn must be light in color, 100% natural Fiber Cotton, wool, or silk and have no stickers or decals. AR undergarments shall not be altered. Hard Hat, Safety Glasses, Rubber Gloves with Leather Protectors when needed or Heavy Duty (=> 12 oz/yd ²) or AR Leather Gloves. Heavy duty over the ankle footwear. Additional outer layers (Jacket, Parka, Rainwear or Hard Hat Liners must be AR).
ARC2	5.0 - 8.0	Same as ARC1
ARC3	8.0 - 20.0	AR20 Cal Clothing System or Lab Coat, all else the same.
ARC4	20.0 - 40.0	AR40 Cal Suit Including 40 Cal Hood, all else same.
Head and face Protection		Suffix F = AR20 Cal Faceshield Suffix B = AR20 Cal Balaclava
<i>Examples</i>	ARC2 - F ARC3 - FB	ARC2 PPE required + Faceshield ARC3 PPE required + Faceshield + Balaclava

Minimum Approach Distances (MADs)

Nominal Voltage (kV) Phase - Phase	Distance (ph - gr exposure)		Distance (ph - ph exposure)	
	ft	inches	ft	inches
0.050 - 0.300	Avoid contact		Avoid contact	
0.301 - 0.750	1.09	14	1.09	14
0.751 - 5.0	2.07	25	2.07	25
5.1 - 15.0	2.14	26	2.24	27
15.1 - 36.0	2.53	31	2.92	36
36.1 - 46.0	2.76	34	3.22	39
46.1 - 72.5	3.29	40	3.94	48
72.5 - 121.0	3.71	45	4.66	56
121.1 - 145.0	4.27	52	5.38	65
145.1 - 169.0	4.79	58	6.36	77
169.1 - 242.0	6.59	80	10.1	122
242.1 - 362.0	11.19	135	18.11	218
362.1 - 420.0	13.94	168	22.34	269
420.1 - 550.0	16.63	200	27.03	325
550.1 - 800.0	22.57	271	37.34	449

**- Provided no insulated tool spans the gap and no large conductive object is in gap*

ASTM D120 Class Specifications for Insulating Rubber Gloves

Class	Proof Test Voltage	Max Use Voltage	Label Color
Class 00	2,500 AC/10,000 DC	500 AC/750 DC	Beige
Class 0	5,000 AC/20,000 DC	1,000 AC/1,500 DC	Red
Class 1	10,000 AC/40,000 DC	7,500 AC/11,250 DC	White
Class 2	20,000 AC/50,000 DC	17,000 AC/25,500 DC	Yellow
Class 3	30,000 AC/60,000 DC	26,500 AC/39,750 DC	Green
Class 4	40,000 AC/70,000 DC	36,000 AC/ 54,000 DC	Orange

ARC Flash Requirements

PPE Requirements by System Category

AF System Category	PPE Level	Boundar	Exceptions/Notes
T&D Substations (2.4 kV - 345 kV)	ARC-2	6 feet	ARC-2 for stick work, consult engineering for Incident Energy levels for Glove work at 15 inches. Grant Street Boundary = 14 feet. Orrington and * Eastern Ave = 9 feet
T&D Lines (2.4 kV - 345 kV)	ARC-2	See Note	The arc flash boundary for all T&D Lines will be equal to the applicable MAD (Minimum Approach Distance) for the nominal voltage of the Line.
Metal Clad Switchgear	ARC-4	See Note	The arc flash boundary for all Metal Clads is anywhere within the metal clad unit. For open rooms (Park Street, etc.), anywhere in the room, for outdoor units 40 feet. Eastport T1L – Scada operate remotely, de-energize for anything beyond until engineered out. If no switching or exposed live parts then ARC-2 is sufficient for brief inspections or meter readings
Padmount XFRM'S 120/240/208 Volt	ARC-2F	6 Feet	None
Padmount XFMR'S 480 Volt	ARC-3FB	6 Feet	AMR Padmount XFMR'S (Secondary Cabinet) Arc Flash Boundary = 13 Feet, ARC-4 or De-energize
OMU Cabinets 480 Volt	ARC-2F	6 Feet	None
Meters 120/240/208 Volt	ARC-2F	6 Feet	Transformer rated meters of any voltage - ARC-2 PPE
Meters 480 Volt	ARC-3FB	6 Feet	480 Volt XFMR Rated = ARC-2 PPE
Panels 120/240/208 Volt	ARC-2F	7 Feet	None
Panels 480 Volt	ARC-3FB	10 Feet	None
Primary Underground (City of Bangor, Loring)	ARC-2	see note	The arc flash boundary for all Underground in this category is within any enclosed area with energized equipment including vaults, manholes, etc. and 6 feet when in open space (above grade switch enclosures, etc.) Any activity involving work with exposed energized conductors or equipment or the operation or switching of equipment requires level ARC – 3FB PPE
URD Underground	ARC-2	see note	Same as above Underground note

Section 5	Transmission and Distribution																																															
Section 5.4	Minimum Approach Distances		Effective Date: 1/1/2016 Revised: 1/1/2017																																													
5.4.1 Purpose	Minimum Approach Distances provide employees with information to help them determine the appropriate protective devices to employ while working on or near energized T&D equipment. This section provides information on the Minimum Approach Distances (MAD)																																															
5.4.2 Responsibilities	<ol style="list-style-type: none"> 1. The Company is responsible for developing and maintaining the MAD charts. 2. Employees are responsible for following the MAD charts. 																																															
5.4.3 Requirements	<ol style="list-style-type: none"> 1. MAD Charts 																																															
5.4.4 Risk Identification	<ol style="list-style-type: none"> 1. Serious injury or death caused by electrical contact. 																																															
5.4.5 Safe Work Practices	<ol style="list-style-type: none"> 1. The MAD charts are meant to provide employees with information regarding safe working distance from energized parts and equipment. It is primarily intended to prevent accidental contact. 2. Only qualified personnel using appropriate PPE and work methods may go beyond any point where it would be possible to reach into the MAD zone. 3. Minimum Approach Distances for qualified employees: <table border="1" style="margin-left: auto; margin-right: auto;"> <thead> <tr> <th rowspan="3">Nominal Voltage (kV)- Phase - Phase</th> <th colspan="2">Distance (ph - gr exposure)</th> <th colspan="2">Distance (ph - ph exposure)</th> </tr> <tr> <th>ft</th> <th>inches</th> <th>ft</th> <th>inches</th> </tr> </thead> <tbody> <tr> <td>0.050 - 0.300</td> <td colspan="2">Avoid contact</td> <td colspan="2">Avoid contact</td> </tr> <tr> <td>0.301 - 0.750</td> <td>1.09</td> <td>14</td> <td>1.09</td> <td>14</td> </tr> <tr> <td>0.751 - 5.0</td> <td>2.07</td> <td>25</td> <td>2.07</td> <td>25</td> </tr> <tr> <td>5.1 - 15.0</td> <td>2.14</td> <td>26</td> <td>2.24</td> <td>27</td> </tr> <tr> <td>15.1 - 36.0</td> <td>2.53</td> <td>31</td> <td>2.92</td> <td>36</td> </tr> <tr> <td>36.1 - 46.0</td> <td>2.76</td> <td>34</td> <td>3.22</td> <td>39</td> </tr> <tr> <td>46.1 - 72.5</td> <td>3.29</td> <td>40</td> <td>3.94</td> <td>48</td> </tr> </tbody> </table> 				Nominal Voltage (kV)- Phase - Phase	Distance (ph - gr exposure)		Distance (ph - ph exposure)		ft	inches	ft	inches	0.050 - 0.300	Avoid contact		Avoid contact		0.301 - 0.750	1.09	14	1.09	14	0.751 - 5.0	2.07	25	2.07	25	5.1 - 15.0	2.14	26	2.24	27	15.1 - 36.0	2.53	31	2.92	36	36.1 - 46.0	2.76	34	3.22	39	46.1 - 72.5	3.29	40	3.94	48
Nominal Voltage (kV)- Phase - Phase	Distance (ph - gr exposure)		Distance (ph - ph exposure)																																													
	ft	inches	ft	inches																																												
	0.050 - 0.300	Avoid contact		Avoid contact																																												
0.301 - 0.750	1.09	14	1.09	14																																												
0.751 - 5.0	2.07	25	2.07	25																																												
5.1 - 15.0	2.14	26	2.24	27																																												
15.1 - 36.0	2.53	31	2.92	36																																												
36.1 - 46.0	2.76	34	3.22	39																																												
46.1 - 72.5	3.29	40	3.94	48																																												

Nominal Voltage (kV)-

Phase - Phase

Distance (ph - gr exposure) Distance (ph - ph exposure*)
ft inches ft inches

72.5 - 121.0	3.71	45	4.66	56
121.1 - 145.0	4.27	52	5.38	65
145.1 - 169.0	4.79	58	6.36	77
169.1 - 242.0	6.59	80	10.1	122
242.1 - 362.0	11.19	135	18.11	218
362.1 - 420.0	13.94	168	22.34	269
420.1 - 550.0	16.63	200	27.03	325
550.1 - 800.0	22.57	271	37.34	449

**-Provided no insulated tool spans the gap and no large conductive object is in gap*

4. Minimum Approach Distances for cranes and uninsulated aerial lifts for qualified employees:
- Distances below are for any part of the crane, uninsulated aerial lift or load.
 - When working in the vicinity of energized conductors with a crane or uninsulated aerial lift, a spotter is required to ensure there is no encroachment in to the MAD zone.
 - Digger-derricks operated by qualified employees are exempt from this requirement per OSHA 29 CFR 1926 subpart V.
 - For the rare circumstance where the MAD zone must be entered with an uninsulated aerial lift, the deviation protocol listed in the Introduction section of this manual shall be followed.

Required Clearance for Operation Near High-Voltage Power Lines Phase to Ground	
0- 50 kV	10'
51-200 kV	15'
201-350 kV	20'
351-500 kV	25'
501-750 kV	35'
751-1000 kV	45'

5.4.6 Definitions

Qualified: a person who, by possession of a recognized degree, certificate, or professional standing, or who by extensive knowledge, training and experience, successfully demonstrates the ability to solve problems relating to the subject matter, the work or the project.

Section 5	Transmission and Distribution	
Section 5.5	Protective Grounding	Effective Date: 1/1/2016 Revised: 2/28/21
5.5.1 Purpose	The basic principle of equal potential grounding is to apply bonding and protective grounds so that all parts of an employee's body (and any surface with which the body makes contact) will be maintained at essentially the same potential should the line or apparatus inadvertently become energized. This section provides information and safe work practices regarding protective grounding. <i>If a primary line is not grounded it must be considered energized and all energized work rules and practices will apply.</i>	
5.5.2 Responsibilities	<ol style="list-style-type: none"> 1. The Company is responsible for training employees in protective grounding techniques. 2. The Company is responsible for providing employees the proper grounding equipment. 3. The supervisor is responsible for ensuring that only qualified employees perform grounding tasks. 4. The employee is responsible for following the safe work practices. 	
5.5.3 Requirements	<ol style="list-style-type: none"> 1. Grounding Equipment <ol style="list-style-type: none"> a. NOR overhead use size 1/0 grounds until replacement 2/0 grounds become available. Note that 1/0 overhead grounds are being replaced with 2/0 in NOR trucks to facilitate working in SOR. b. SOR overhead use size 2/0 grounds except use 4/0 grounds for Graham 46kV bus, Orrington 13.8kV bus, & Keene Rd 345 Tertiary 12.5kV bus c. For NOR & SOR underground grounding sizing requirements see section 5.5.5. 7d 2. For Terminal Grounding the acceptable master trip grounding point is the ground grid at the substation or switching ground grid (if available) 3. For other than terminal grounding the only approved grounding attachment points in order of preference are: <ol style="list-style-type: none"> a. System neutral (when available) b. Existing ground rod or driven ground rod c. Anchor rod (except ledge anchor) 4. PPE 5. Hot line tools 	
5.5.4 Risk Identification	<ol style="list-style-type: none"> 1. Serious injury or death caused by electrical contact. 	
5.5.5 Safe Work	<ol style="list-style-type: none"> 1. Equipotential Zone (EPZ) Grounding Life Saving Rules <ol style="list-style-type: none"> a. Guy wires cannot be used as a grounding point. 	

Practices

- b. All conductors and clamp heads must be wire brushed prior to attaching grounds.
- c. Cluster bars must be used on poles when required.
- d. When all conductors are broken & separated, the first connection to establish an EPZ between the two potentials requires a bond to be installed using an insulated stick and rubber gloves.
- e. Rubber gloves must be used when handling a conductor on the ground.

2. General

- a. Switching and tagging shall be completed in accordance with **Section 6 Switching and Tagging** prior to placing personal protective grounds.
- b. A visible opening shall be established between a conductor or equipment to be worked and any source. The conductor or equipment shall be isolated, tagged, tested and then immediately grounded.
- c. Each phase shall be checked with the voltage tester to ensure they are not energized prior to applying protective grounds.
- d. Refer to **Section 5.5 Attachment B** for grounding diagrams.
- e. Employees shall only use the protective grounds manufactured or approved by the Safety Test Lab.
- f. Protective grounds shall be inspected before use & tested annually per **Section 5.5 Attachment C**.
- g. Grounding connections shall be wire brushed before being made. Clamp jaws of the grounding cable must also be wire brushed.
- h. Ground clamps shall not be installed over armor rod.
- i. Pole down grounds shall not be used as a point of grounding.
- j. Guy wires shall not be used as a point of grounding.
- k. Grounding connections shall be properly tightened.
- l. The ground potential end of grounding conductors may be applied and removed by hand. Ground potential connections shall always be applied first and removed last.
- m. The energized end of grounding conductors shall be applied and removed only with hot-line tools.
- n. Rubber gloves shall be worn while placing personal protective grounds with hot-line tools.
- o. In general, connections to conductors and equipment for protective grounding purposes should be made as the worker encounters them. The first connection should be made to one of the three approved attachment points: existing neutral, existing ground rod or driven ground rod, or anchor rod (non-ledge type). Any cluster bars employed shall be connected to the protective grounding system. Grounds should be removed in reverse order of installation.

- p. Excluding Terminal Grounding, grounding shall be installed as close as possible to the work site, but far enough away so that contact with the employee is avoided. Employees should maintain a 15 foot distance from the installed grounding electrode.
- q. Ground conductors shall be as short as possible to complete the work. In no case shall ground conductors be coiled.
- r. Protective grounds shall be properly stored.

3. Equal Potential Grounding - Single Point

- a. Single point grounding shall not be used for the maintenance or repair of broken conductors or buss.
- b. Work involving single point grounding shall extend no more than one mile from the grounding location.
- c. Cluster bars shall be installed at a location close to but below the location of the worker's feet, even while working from a bucket.
- d. If working from a bucket where an employee can't touch a pole or crossarm, a cluster bar is not required.
- e. On multi-pole structures, a cluster bar connected to the grounded circuit shall be installed below the work area on each pole on which employees will be working.
- f. When working from a box girder these steps shall be followed:
 - i. Inspect the tower down ground to ensure integrity and connection to ground grid.
 - ii. Ground connections shall be made to the down ground at a point below the work area.
 - iii. Connections shall then be made to the first phase and then the remaining ungrounded phases in sequence.

4. Equal Potential Grounding - Bracket Grounding

- a. Bracket grounding will be required any time repairs must be made to down or broken conductors or when conductors or buss are to be cut, spliced, or opened up in any manner.
- b. On overhead lines, a bracket ground shall be installed on the nearest pole to either side of the work area. In no case shall the distance between grounds exceed one mile.
- c. If working from a bucket where an employee cannot touch a pole or crossarm, a cluster bar is not required.
- d. On multi-pole structures, a cluster bar connected to the grounded phase shall be installed below the work area on each pole on which employees will be working.
- e. Employees handling conductors on the ground shall wear rubber gloves. Since the lines have been grounded by the bracket method, rubber gloves will be considered secondary protection. The rubber gloves will serve as insulation from the difference in potential between the worker on the ground and the conductor.

5. Equal Potential Grounding – Terminal Grounding

- a. Master/tripping grounds used for 3 wire transmission systems

that do not have a neutral available are established at a terminal location (typically a substation or switch grounding grid).

- b. ONLY the conductors, static wires, poles, apparatus, etc. that are in the worker's zone (within reach) need to be bonded into the EPZ at the work site.

6. Static Wire

- a. On overhead transmission lines, the static wire (where available) shall be tied into the EPZ.
- b. On wood structures, ground connections shall be made directly upon the static wire and not on pole grounds.
- c. When more than one static wire is present on a structure at least two cluster bars shall be used.
- d. On metal structures grounding lugs may be used in place of the static wire.

7. Testing for Voltage

- a. The voltage tester shall be used in accordance with the manufacturer's recommendations.
- b. The voltage tester shall be attached to the appropriate length hot-line tool.
- c. Prior to testing for voltage, employees shall ensure the voltage tester is operable: preferably at the voltage class to be tested.
- d. If the voltage tester is not operable, return and obtain a replacement.

8. Truck, Crane and Man Lift Grounding

- a. Refer to **Section 5.4 Minimum Approach Distances** for equipment MAD zone clearances.
- b. All digger-derrick trucks are to be grounded when the uninsulated portion of the boom or the load is within the MAD zone.
- c. A man basket shall be electrically bonded to grounded lines before work commences.
- d. When grounding vehicles and equipment, one of the following methods shall be used:
 - i. Connect a grounding conductor from the truck to the system neutral on the pole.
 - ii. Connect a grounding conductor from the truck to a ground rod at the pole if one exists (be sure ground rod is connected to the system neutral).
 - iii. If a ground rod is not present, place a ground rod and connect a grounding conductor from the truck to the ground rod.
 - iv. Connect a grounding conductor from the truck to an existing anchor rod.
 - v. Connect a grounding conductor to a substation ground grid.
- e. Equipment requiring a grounding conductor shall be so equipped. Either one of two following methods is acceptable:

	<ul style="list-style-type: none"> i. A reel of grounding wire installed on the truck and electrically bonded to the frame. All of the conductor shall be completely spooled off the reel. ii. A grounding lug with a clean tab installed on the truck and electrically bonded to the frame. Use an external conductor to accomplish grounding. <ul style="list-style-type: none"> f. Trailers & Equipment inside a substation fence shall be connected to the substation ground grid. g. Equipment located outside the substation fence and handling loads within the fence shall be connected to the substation ground grid. h. Longer equipment may require more than one connection. <p>9. URD Grounding</p> <ul style="list-style-type: none"> a. Prior to entering any underground structure more than five feet deep, a Confined Space Entry Permit shall be completed. Refer to Section 2.12 Confined Space Entry Policy for more information. b. Refer to Section 5.3 Arc Flash for information on arc flash PPE. c. Refer to Section 5.9.5 Safe Work Practices for Rubber Glove Use when working with padmounts, metering, and URD enclosures. d. Grounding URD equipment requirements: <ul style="list-style-type: none"> i. For all URD locations throughout Versant Power’s service territory, 1/0 grounds are adequate for proper grounding <u>except</u>: <ul style="list-style-type: none"> 1. All Hogan Rd circuits require 2/0 grounds. 2/0 grounding kits are located at Graham Station. e. All field employees shall participate in One-Line/EPZ/Approaching and Testing Equipment/Grounding URD Equipment Training offered through the Training Department and practice these methods when approaching, testing, and grounding URD equipment. f. Refer to Section 5.5 Attachment B pages 18 thru 31 for details on URD Grounding
<p>5.5.6 Definitions</p>	<p>Armor Rod: Stranded preformed wire rods that are wrapped on existing conductors & designed to protect cable against bending, compression, abrasion, and flash-over. They are also used to repair damaged aluminum-based conductors and restore the conductors' mechanical strength and conductivity.</p> <p>Bracket Grounding: bracket grounding refers to the process of installing a set of equal potential grounds on both sides of a work site. This process is used when working on broken conductors.</p> <p>Cluster Bar: a bracket allowing the connection of more than one personal protective ground.</p> <p>Equal Potential Grounding: an electrical connection maintaining various exposed conductive parts at substantially the same voltage potential.</p>

	<p>Single Point Grounding: refers to the process of installing one set of equal potential grounds at the immediate work site only.</p> <p>Static Wire: a grounded wire at the very top of the pole intended to protect lower conductors from lightning.</p> <p>Terminal Ground: master/tripping grounds located at the terminal location, this would normally be at a substation ground grid or switch ground grid. The purpose of this ground is to allow the protective devices to operate as designed and as quickly as possible. The grounding of the line is not considered personal protection for the worker.</p> <p>Voltage Tester: a piece of equipment used to detect the presence of voltage in a conductor.</p>
--	---

Grounding Sketches

Figure 1- Single Phase with Neutral

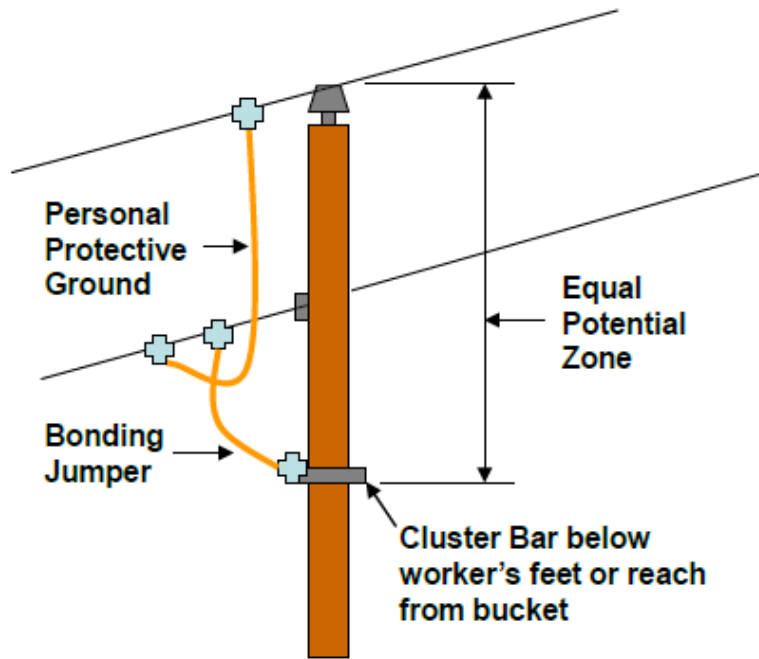

Note: Brush conductors and ground clamp jaws clean before installing grounds

Legend

- Salisbury Ground Clamp
- Equal Potential Cluster Bar
- Substation Buss C-Head Ground Clamp
- Orange Grounds/Zone Identification Flag
- Road Cone

Note: Brush conductors and ground clamp jaws clean before installing grounds

Exhibit 3 - Three Phase With Neutral T-Configuration

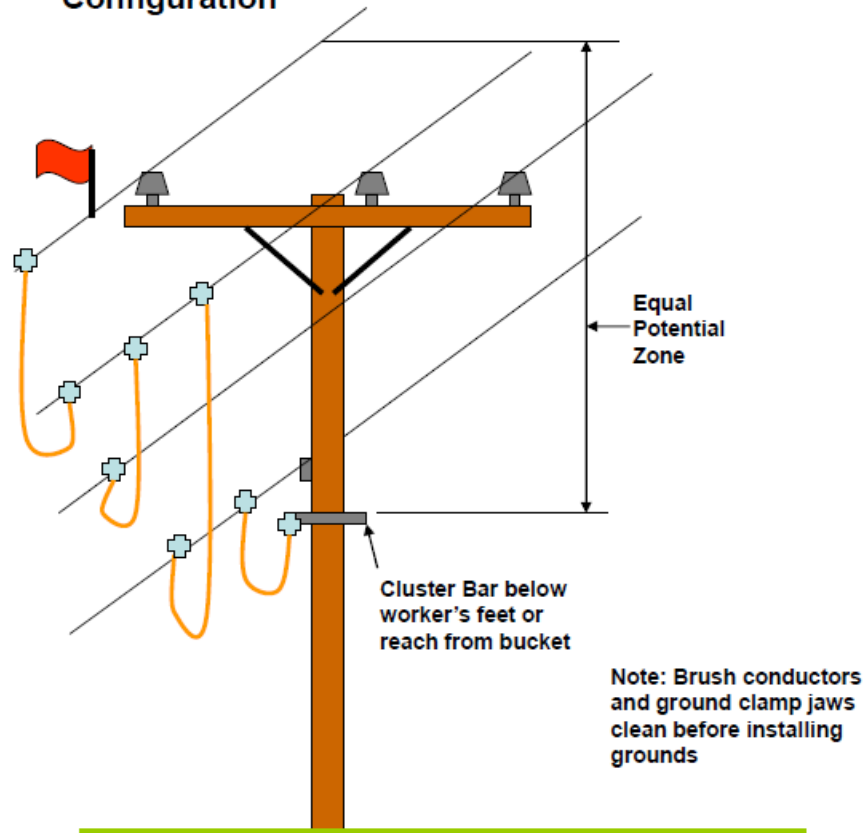

Exhibit 4 – All Conductors Broken T-Configuration

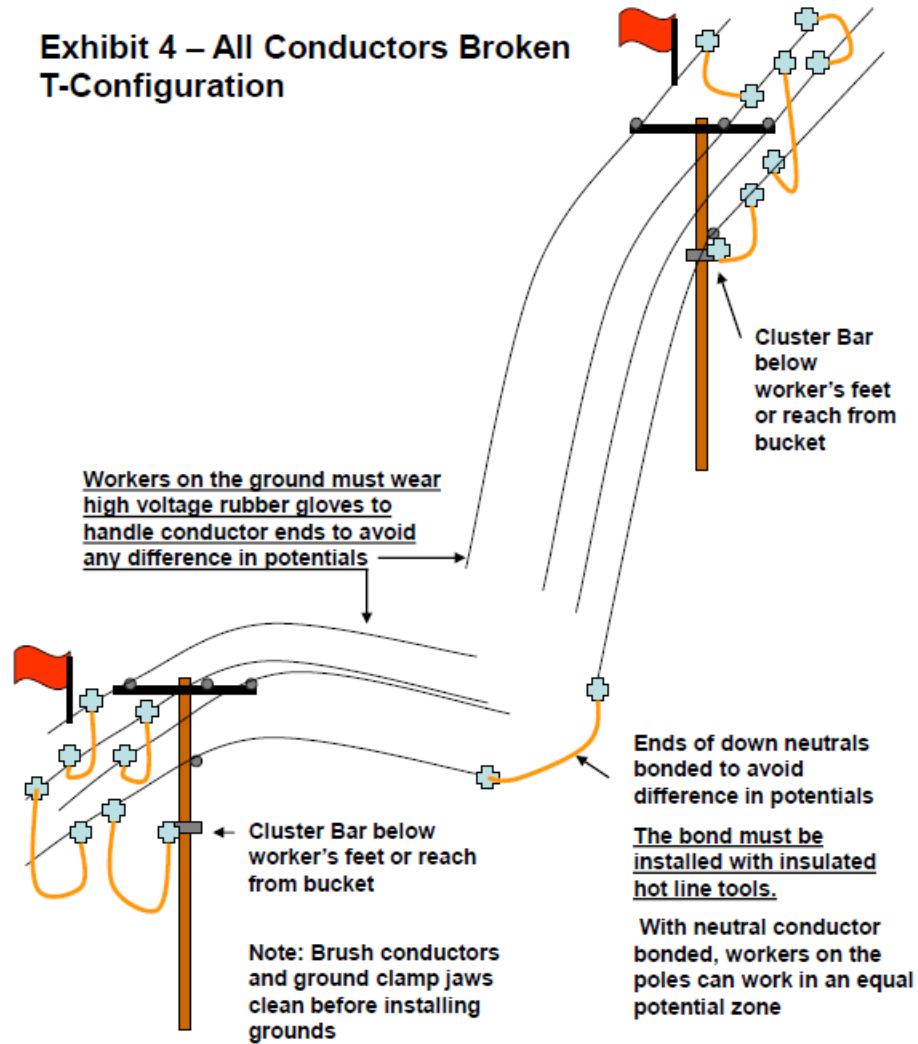
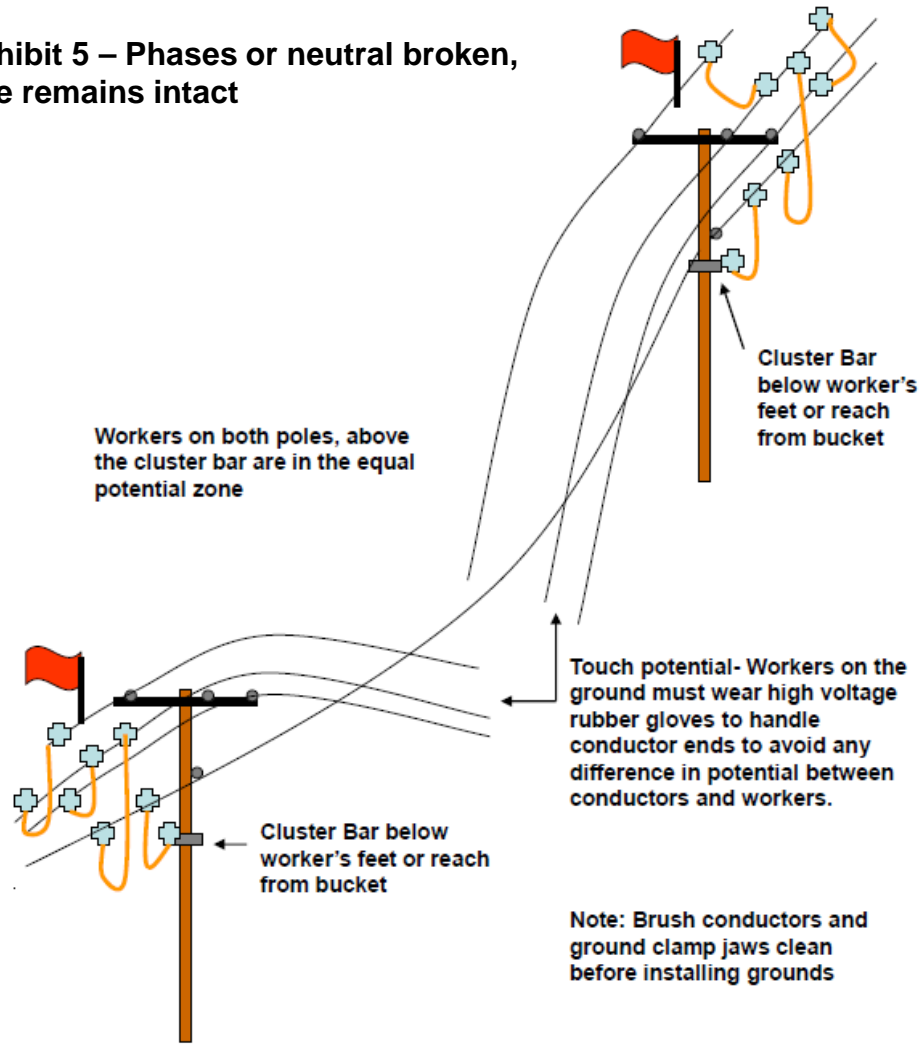

Exhibit 5 – Phases or neutral broken, one remains intact



H-Frame Construction with neutral

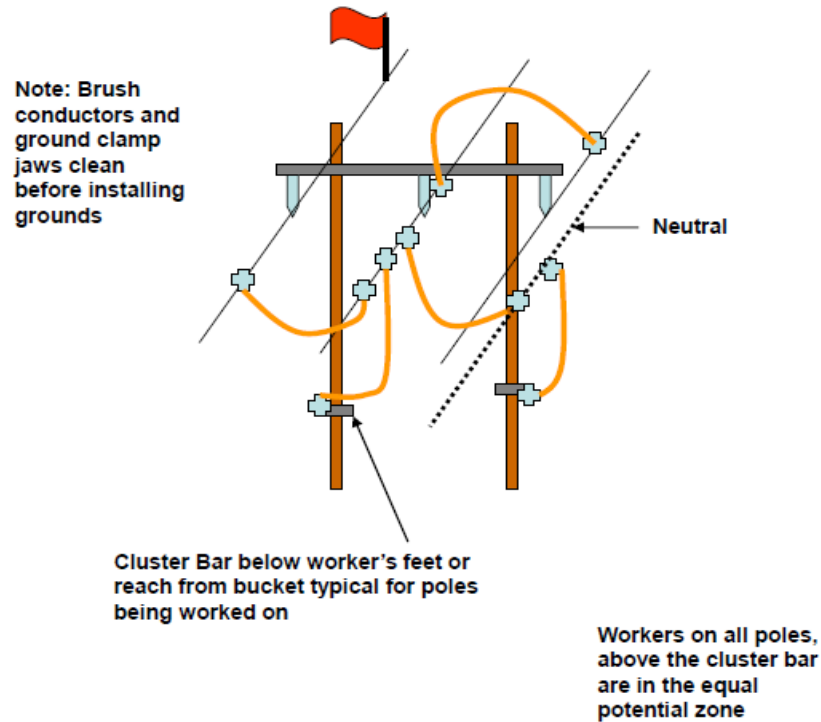
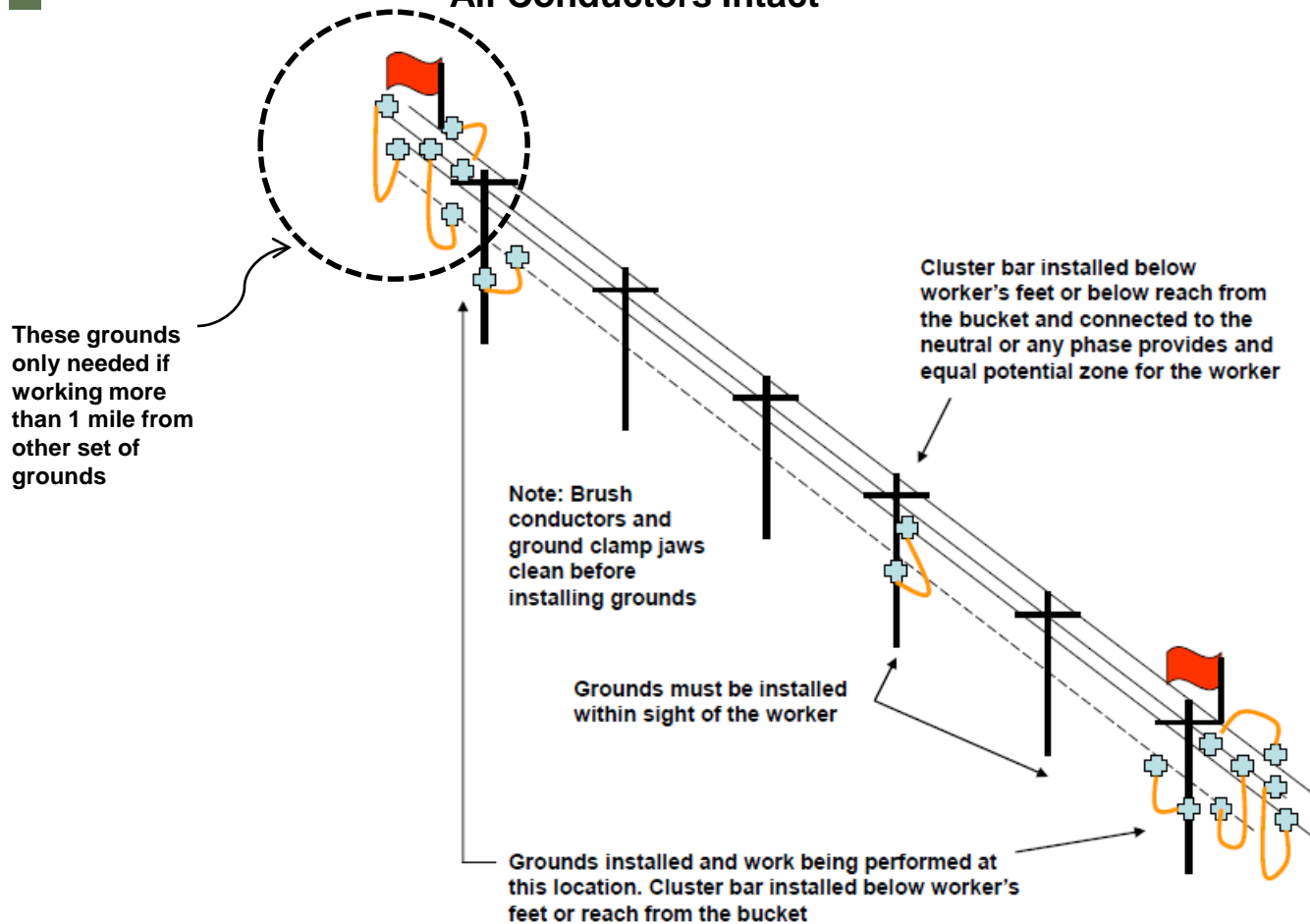
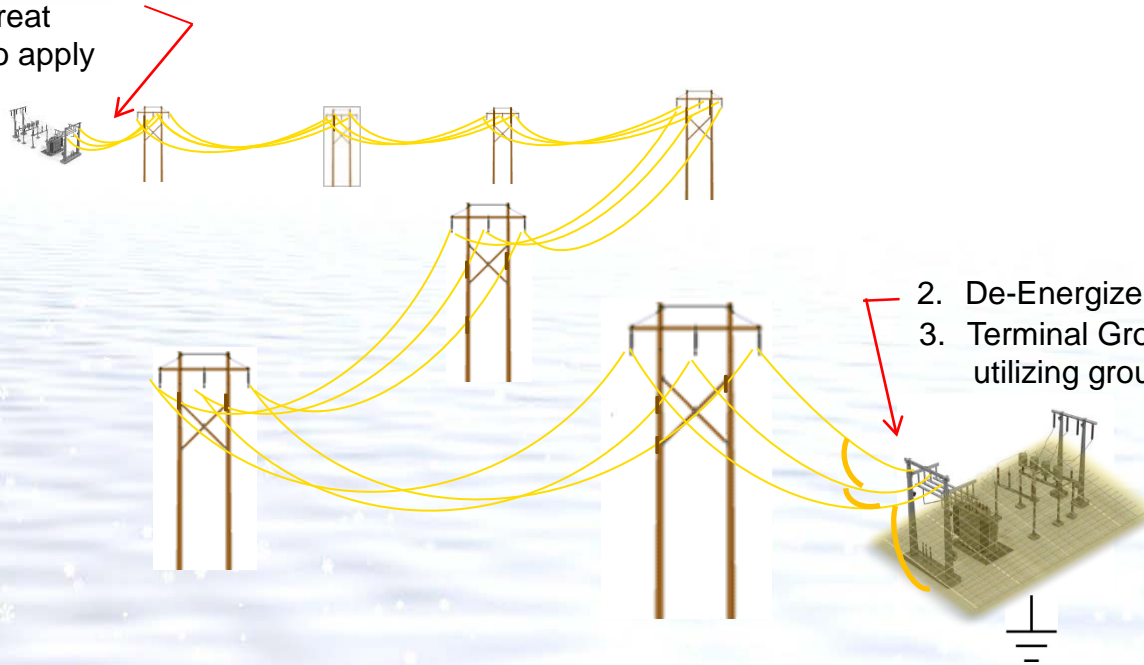

Exhibit 9 – Working Multiple Structures – All Conductors Intact



3-Wire Transmission with No Neutral

1. De-Energize, Isolate & Red Tag
4. It may be necessary if great distances are involved to apply grounds on both ends.



2. De-Energize, Isolate and Red Tag
3. Terminal Grounds Installed utilizing ground grid

Terminal Ground Definition: Master/tripping grounds at terminal location. The purpose of this ground is to allow the protective devices to operate as designed and as quickly as possible. The grounding of the line is not personal protection for the worker.

3-Wire Transmission with No Neutral Work Site EPZ

1. Cluster bar is installed below worker's feet, either in a bucket or off hooks.
2. Line is tested for the absence of voltage and connections are brushed with rubber gloves and a hot stick.
3. Pole and nearest phase are bonded into an EPZ with rubber gloves and hot stick – Personal Shunt.
4. Other two phases are brought into the EPZ using the same method if they are going to be in the worker's zone.
5. Static wires will be included if they are going to be in the workers zone and bonded in the same fashion.
6. ONLY the conductors, static wires, poles ,apparatus, etc. that are in the worker's zone need to be bonded because of the grounding at the terminal.

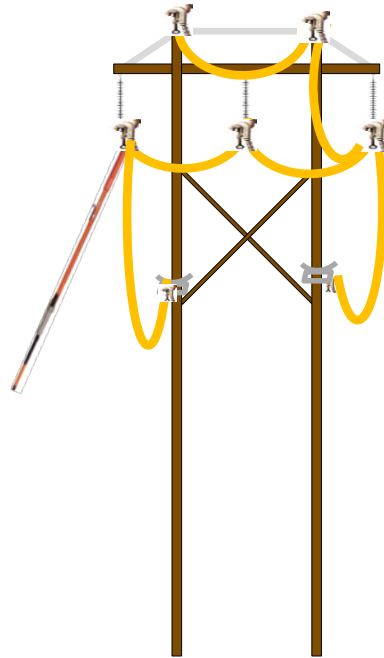

This connection is made with rubber gloves and a hot stick.

The cluster bar and connected ground lead may be installed with leather gloves.

7. If the other pole needs to be included in the EPZ, it must be bonded into the zone as well.

Terminal Grounds
onto ground grid
(Not Personal
Protection)

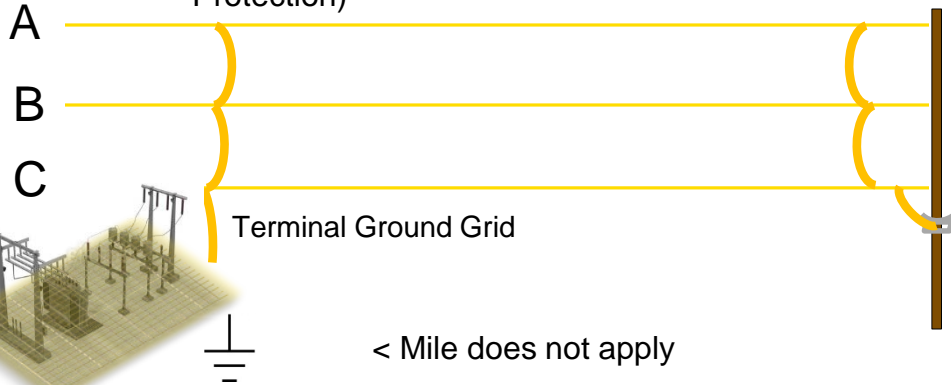

3 Wire
Transmission
w/o Neutral

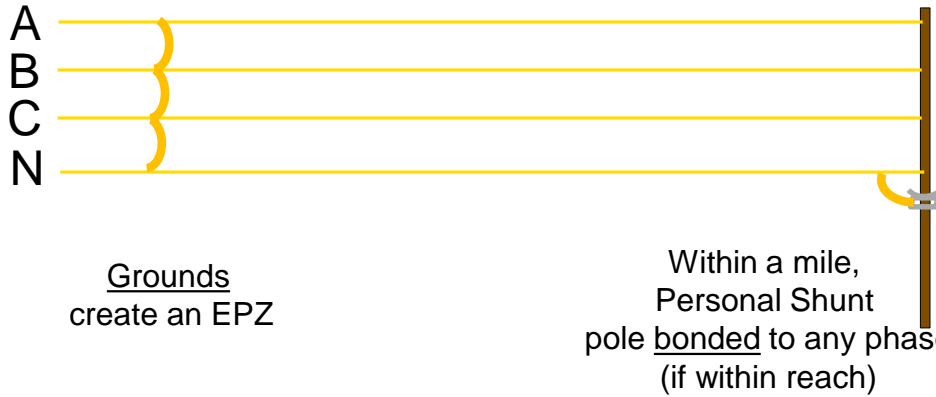

WYE
Distribution
System

When applying grounds, where can rubber gloves be used and where must a hot stick be used? De-energized, isolated and red tagged. Conductors, clamps and bar are brushed.

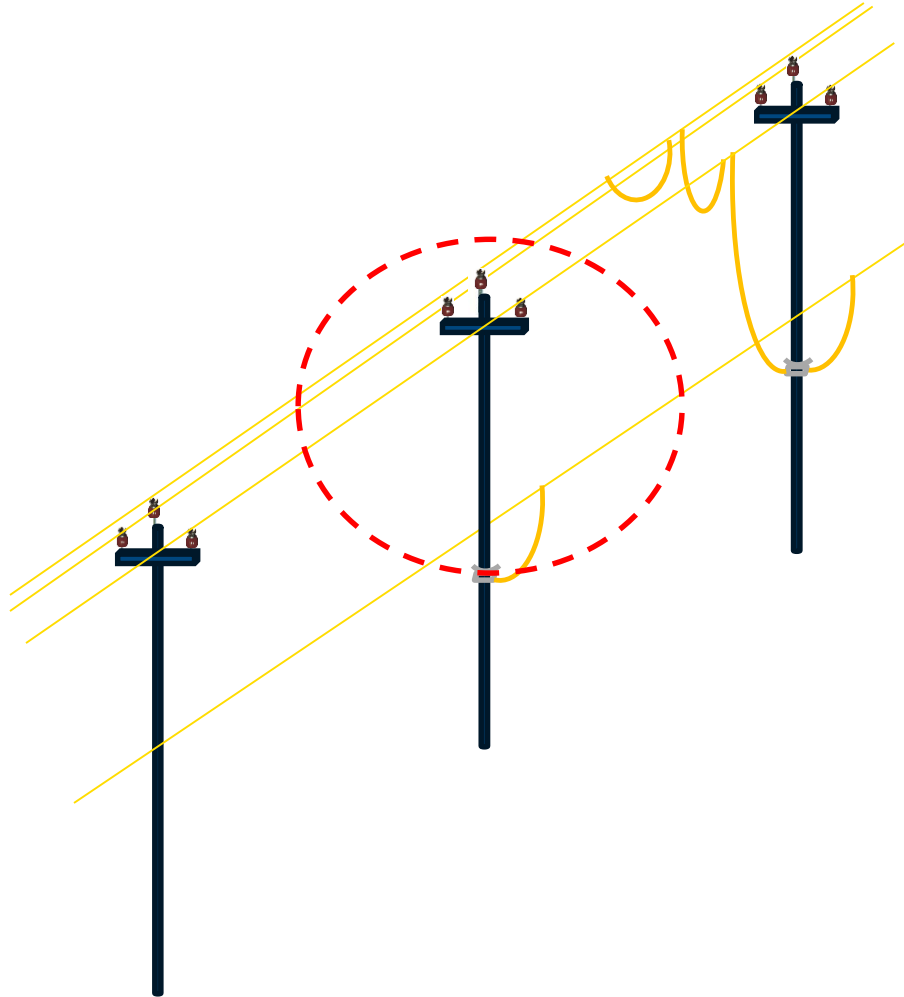

1. “Ground” installation – Cluster bar is installed below worker’s feet using rubber gloves. If this is 40” or more below the neutral, leather gloves may be worn.
2. The ground may be installed to cluster bar and to neutral with rubber gloves.
3. The cluster bar end of the ground may be installed with rubber gloves, but the connection to the nearest phase must be done with a hot stick to mitigate arc flash potential.
4. Subsequent ground sets are installed in same manner.
5. Creating an EPZ within a mile of ground set, worker may install cluster bar as above.
6. Connection to the bar may be made with rubber gloves, but bonding into the EPZ is done with a hot stick.
7. Once the EPZ is established, work may be done with leather gloves.

Small tree on an energized line with little/no line deflection.



1. Tree may be removed with insulated pruning saw and rubber gloves from bucket.
2. If not encroaching into the “MAD” zone, no tags are required.

Contract Tree Crew

1. Tree crews may also remove tree in same scenario.
2. They must not encroach into the “MAD” zone.
3. They are not required to wear rubber gloves.

Large tree on an energized line with line deflection.

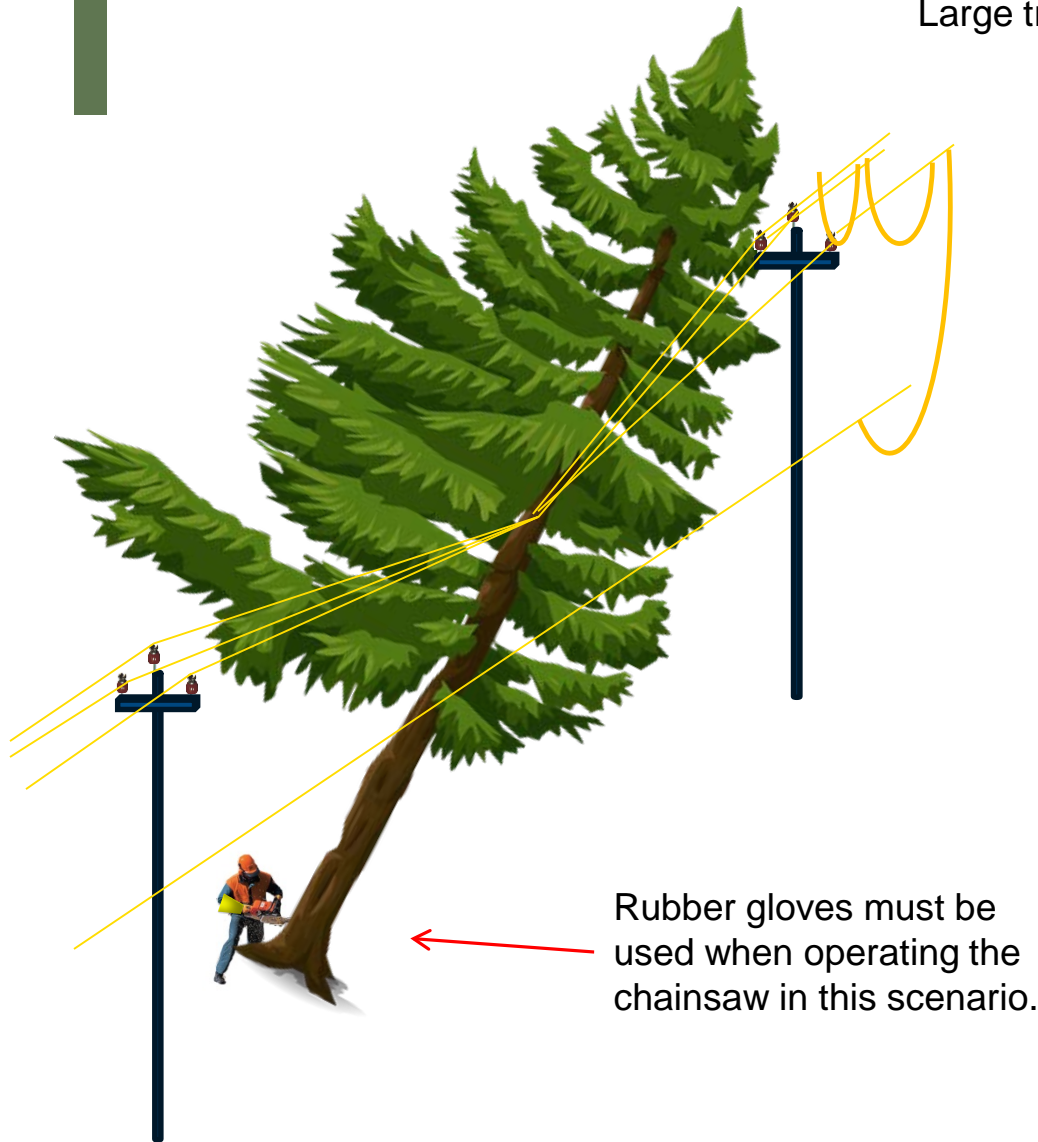

1. De-energize.
2. If tree can be removed with insulating pruning saw and rubber gloves, maintaining “MAD”, no grounds required.
3. If chainsaw is needed from bucket, line must be isolated, red tagged and grounds installed.
4. Once grounds are installed, leather gloves may be used from the bucket.
5. Do not get between conductors and tree to avoid difference in potential.

Contract Tree Crew

1. Tree crews may also remove tree in same scenario.
2. They must not encroach into the “MAD” zone.
3. They are not required to wear rubber gloves as they are never allowed into the “MAD”.

Notes

1. Ground crew must obtain red tag protection and have grounds installed.

Mobile Sub Grounding

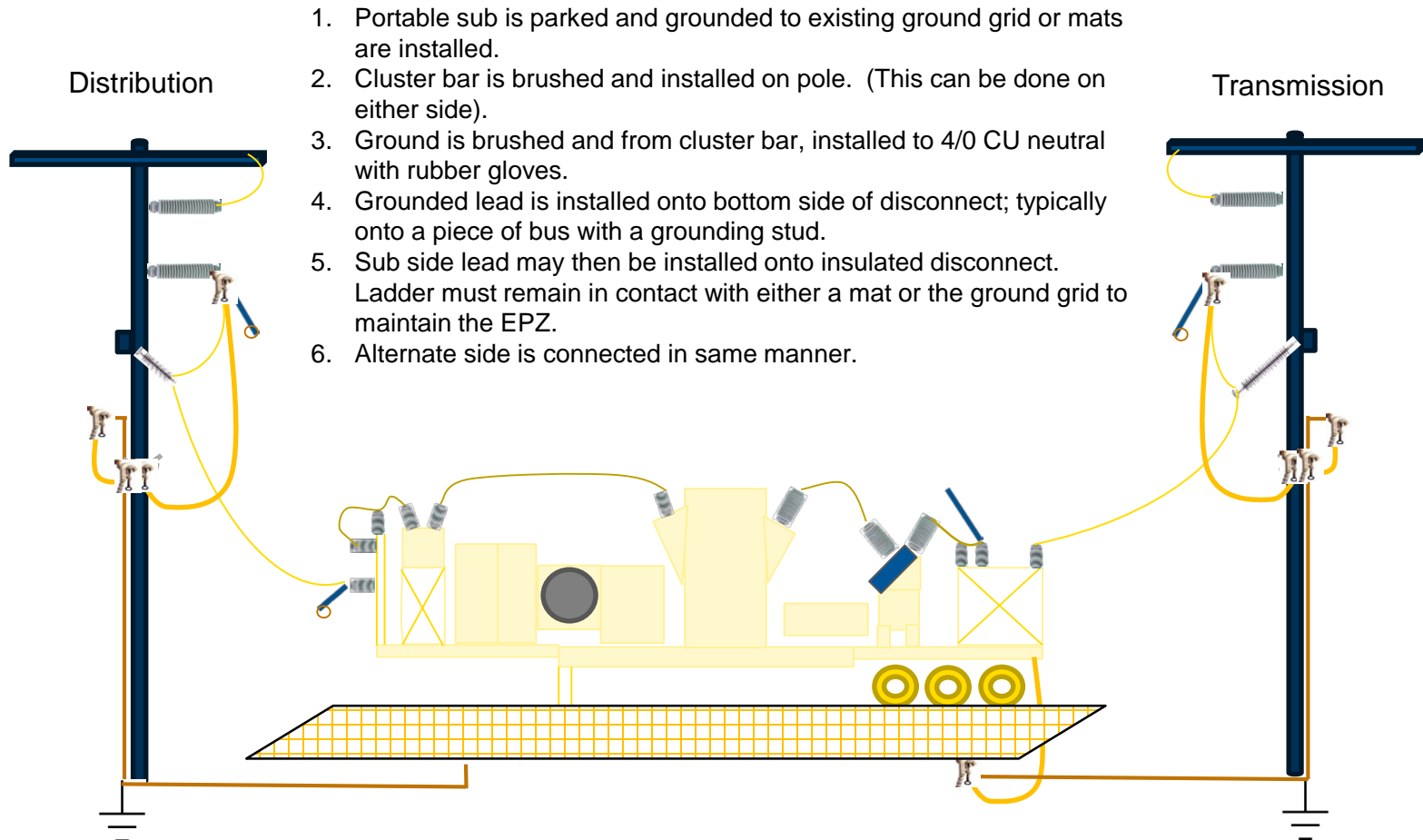

1. Portable sub is parked and grounded to existing ground grid or mats are installed.
2. Cluster bar is brushed and installed on pole. (This can be done on either side).
3. Ground is brushed and from cluster bar, installed to 4/0 CU neutral with rubber gloves.
4. Grounded lead is installed onto bottom side of disconnect; typically onto a piece of bus with a grounding stud.
5. Sub side lead may then be installed onto insulated disconnect. Ladder must remain in contact with either a mat or the ground grid to maintain the EPZ.
6. Alternate side is connected in same manner.

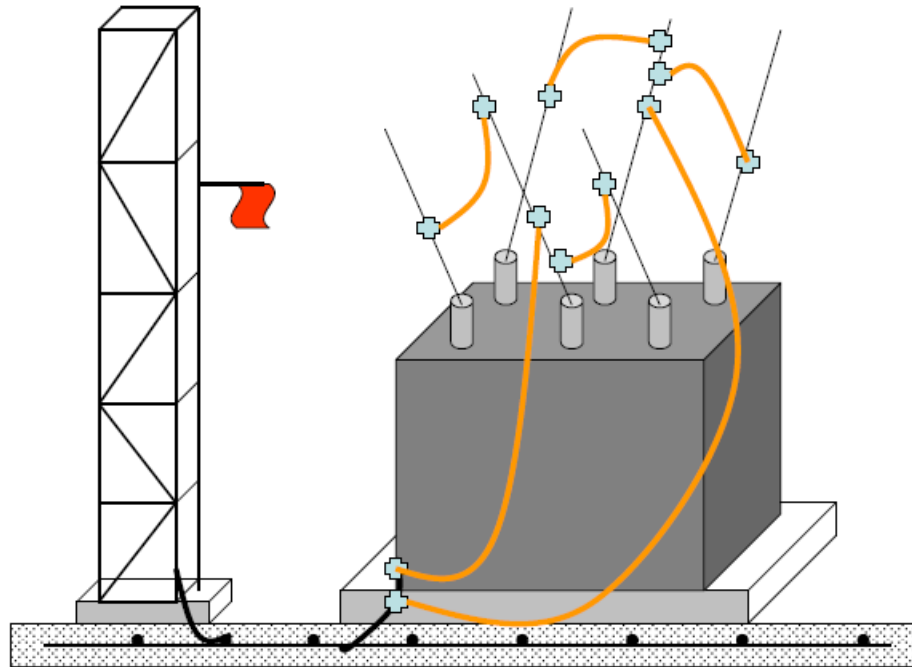
Exhibit 10 - Substation Grounding T- Configuration

Inspect the integrity of the equipment grounds before installing and personal protective grounds. Equipment grounds must be brushed clean to remove any contamination prior to installing grounds

Exhibit 11 - Substation Buss Grounding Configuration

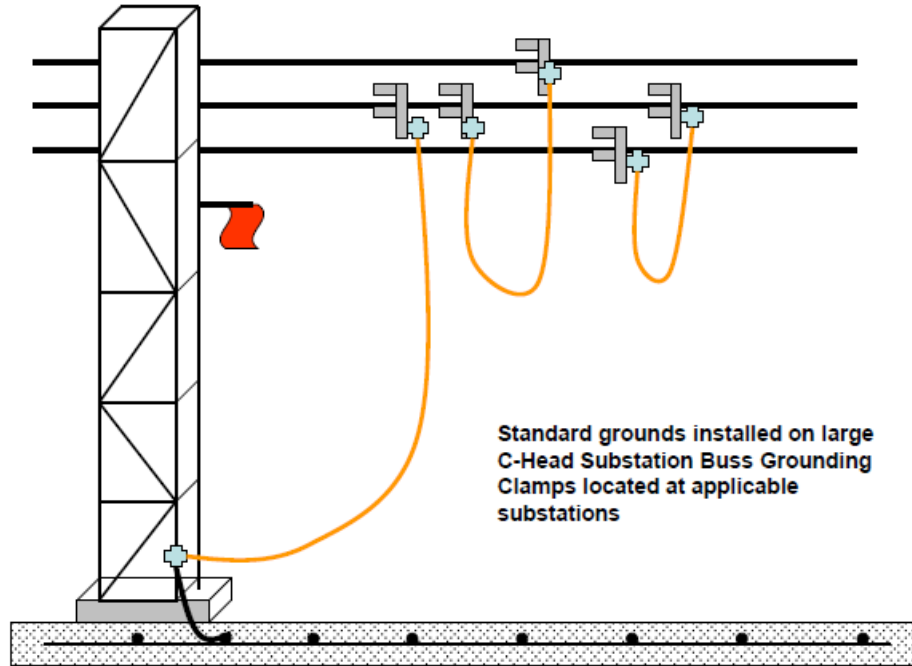

Inspect the integrity of the equipment grounds before installing and personal protective grounds. Equipment grounds must be brushed clean to remove any contamination prior to installing grounds

Exhibit 12 – Wire Trailer Grounding Set up

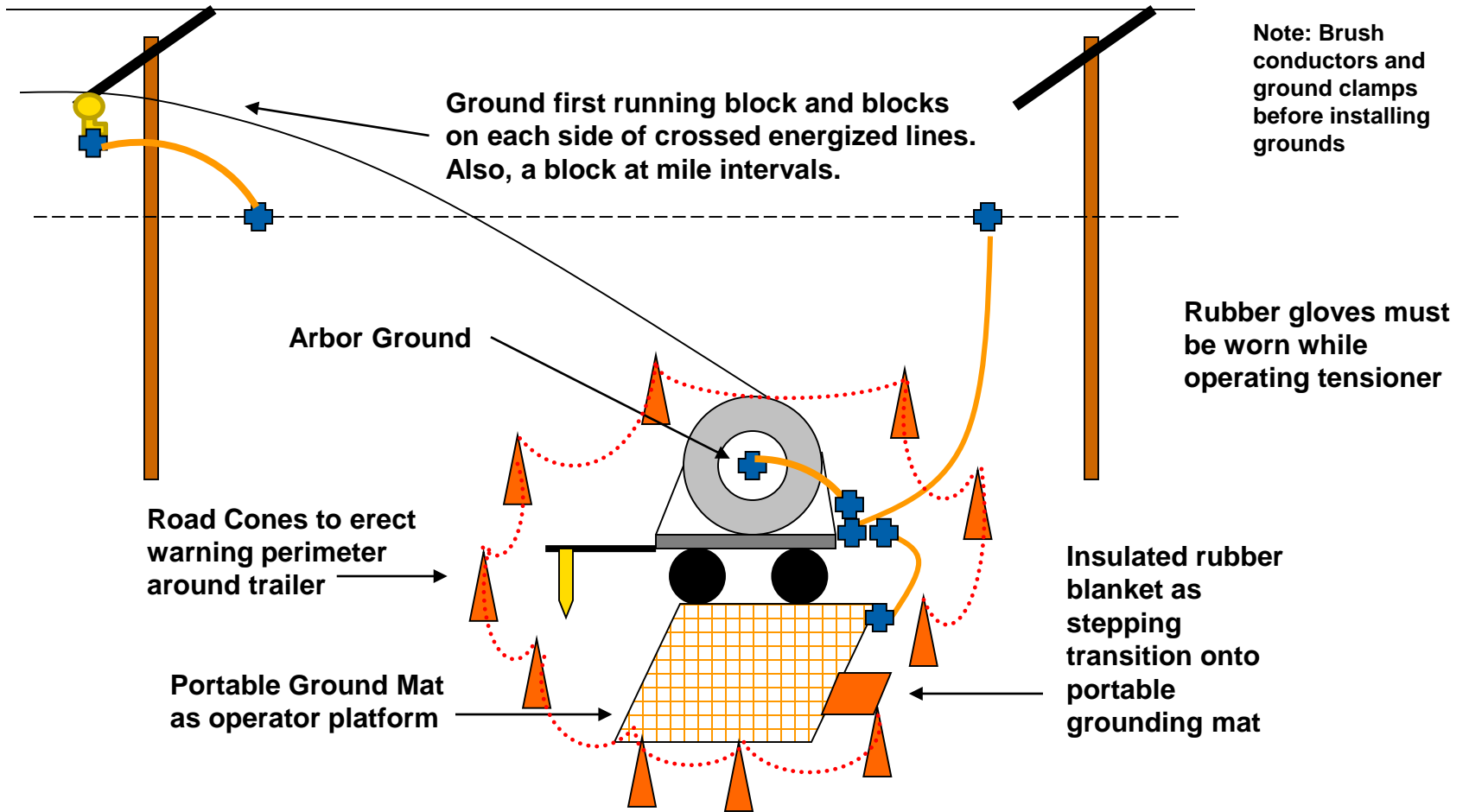

Pad Mount Transformer Grounding

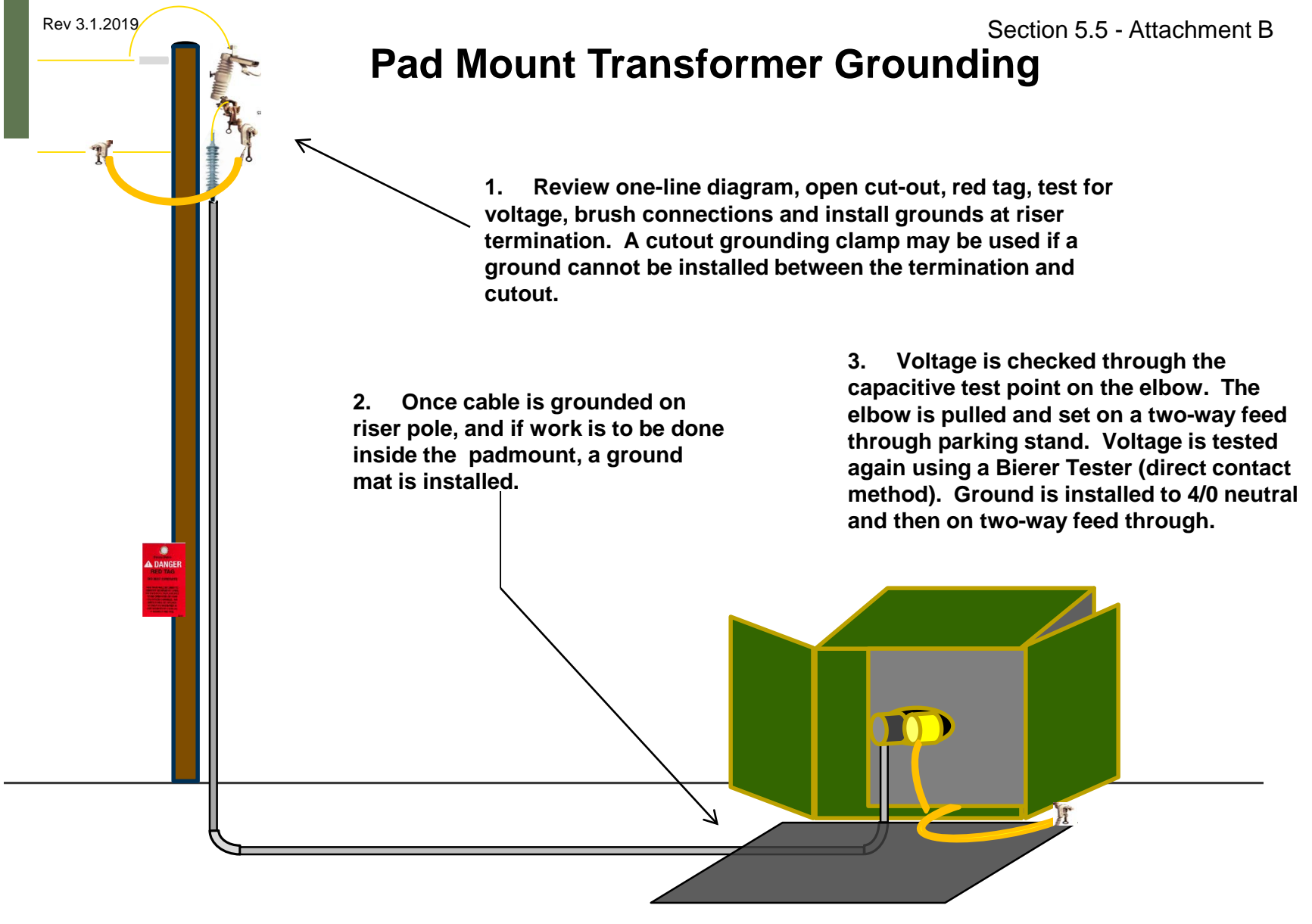

1. Review one-line diagram, open cut-out, red tag, test for voltage, brush connections and install grounds at riser termination. A cutout grounding clamp may be used if a ground cannot be installed between the termination and cutout.

2. Once cable is grounded on riser pole, and if work is to be done inside the padmount, a ground mat is installed.

3. Voltage is checked through the capacitive test point on the elbow. The elbow is pulled and set on a two-way feed through parking stand. Voltage is tested again using a Bierer Tester (direct contact method). Ground is installed to 4/0 neutral and then on two-way feed through.

Contractor Work on Secondary Versant Power (VP) Pad Mount Customer Owned Secondary Equipment VP Will Do No Work

1. **Safety Equipment Needed:** Properly Rated Rubber Gloves, Voltage Testers (Primary and Secondary), Correct PPE for ARC flash requirements (Reference Versant Power Section 5.3 AF Cheat Sheet)
2. Open Cut-Out(s) on pole, red tag, test, brush connections and install ground.
3. Wear rubber gloves and appropriate FR PPE (Clothes, Head and Face Protection) to open door of padmount transformer to verify equipment grounding.
4. Verify no visible Primary back feed on transformer.
5. EPZ mat is installed.
6. Until the absence of secondary voltage is proven, persons without appropriate FR PPE must be clear of the ARC Boundary (Reference Safety Manual Section 5.5.3 AF Cheat Sheet). Reference One-Line Diagram to verify Feed(s) match what you are seeing.
7. If there is a way to back feed through the primary, you will need to find the source cutouts to open and de-energize and follow the same steps for a RT.
8. Wear rubber gloves and appropriate FR PPE to test secondary voltage is not present. You can do this at secondary paddles in the padmount transformer.
9. Make sure to pull meter and blank off or open meter breaker and install a lock with a Low Voltage Lock Out Tag to make sure you are protected from any customer back feed.
10. Versant Power **must** stay on site while the equipment is Red Tagged.
11. Pad mount transformers that are locked with a Versant Power pad lock can have cutouts pulled, high side tap removed and white tag installed. Crew shall verify that no voltage is present on the secondary side. (Reference Safety Manual Section 6.8.5.2 exception d)

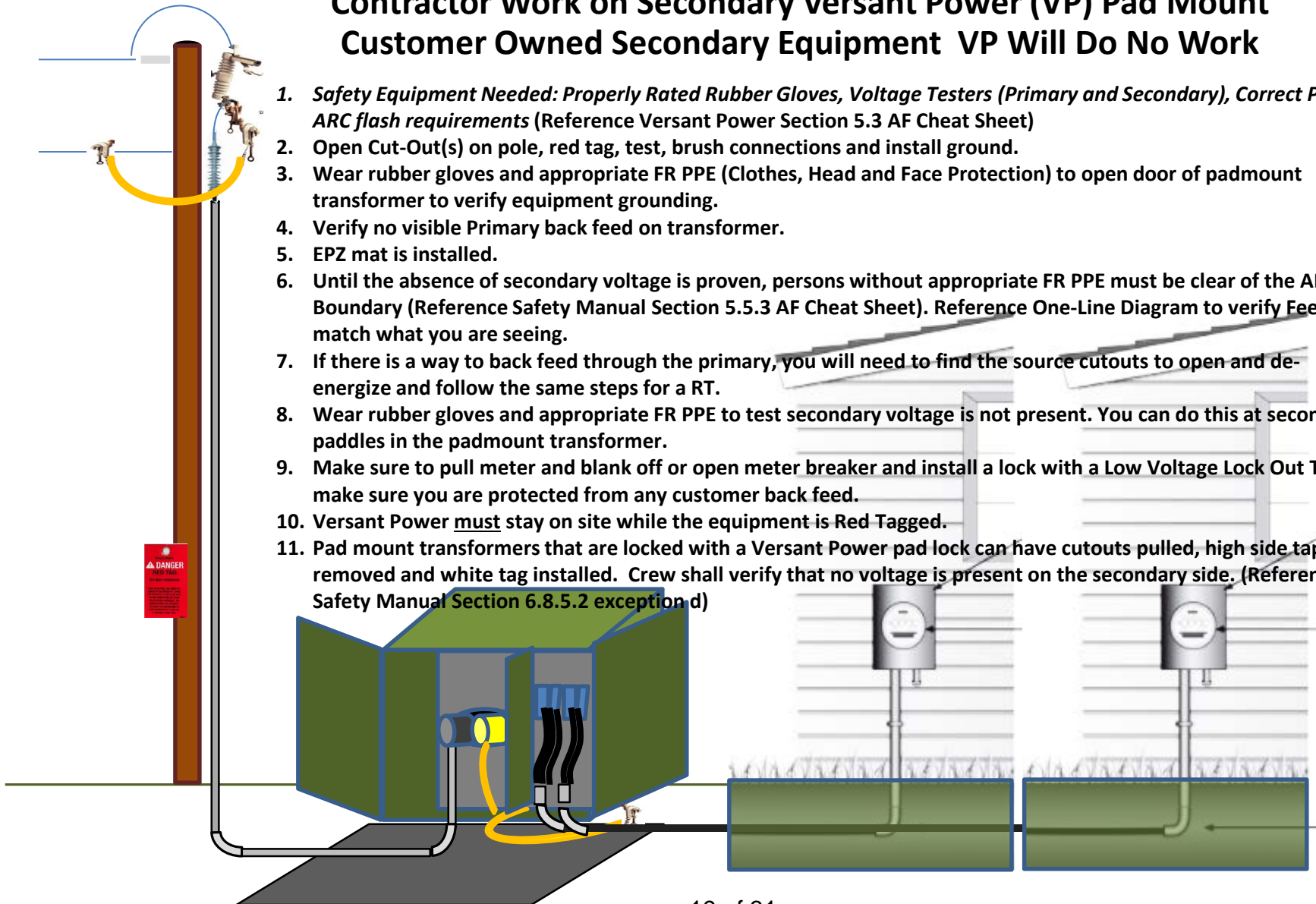

Contractor Work on Private Installation Customer Owned Pad Mount Customer Owned Line and Equipment Versant Power Will Do No Work

1. **Safety Equipment Needed: Properly Rated Rubber Gloves, Voltage Testers (Primary and Secondary), Correct PPE for ARC flash requirements (Reference Versant Power Section 5.3 AF Cheat Sheet).**
2. **Open cutout(s) on pole, Test, Brush Connections, Ground, Un-tap cutouts and White tag**
3. **Note: If customer hires Versant Power to perform work, all rules pertaining to EPZ mat must be followed and a red tag would be required.**

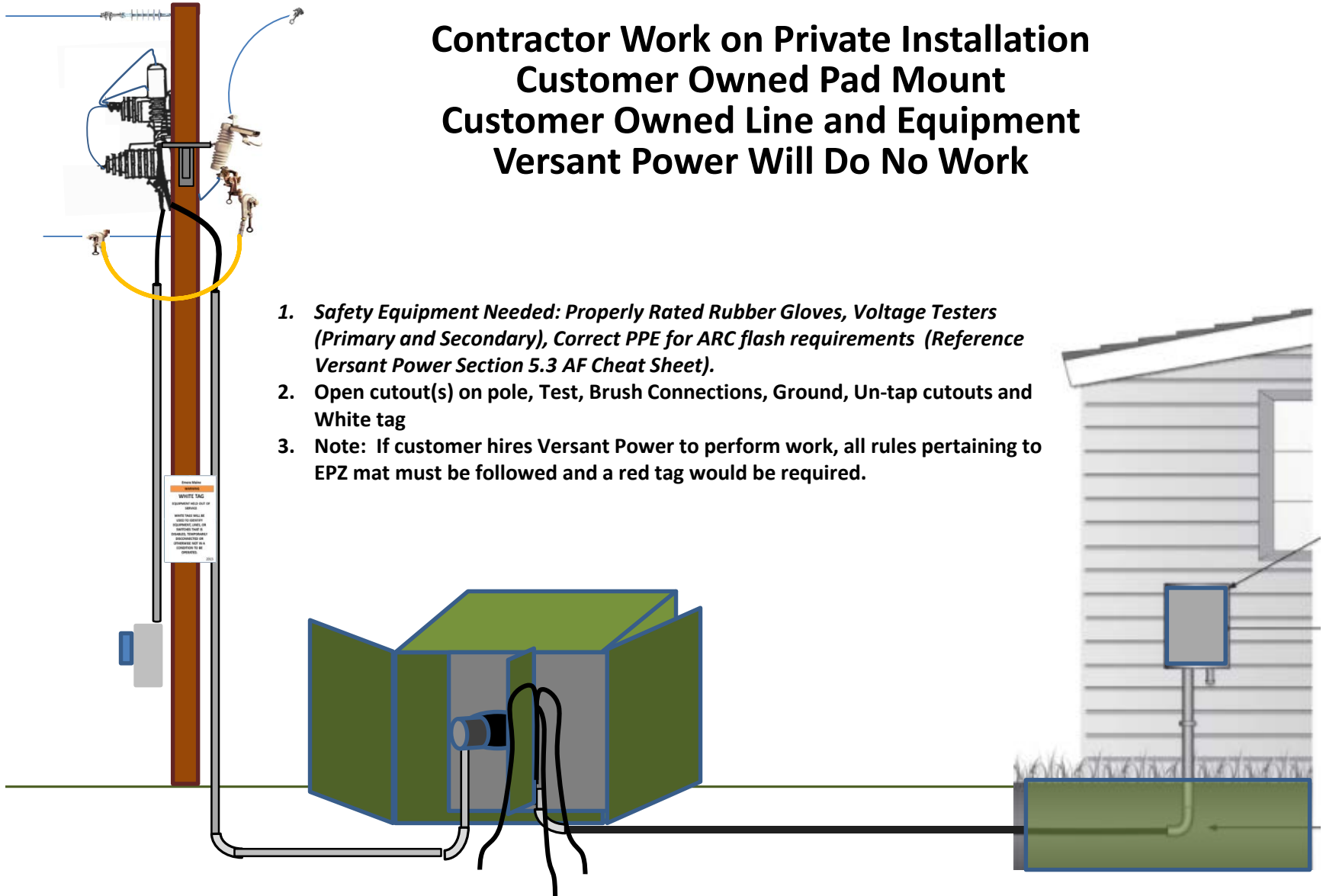

Versant Power Work on Secondary Side of Pad Mount

1. **Safety Equipment Needed: Properly Rated Rubber Gloves, Voltage Testers (Primary and Secondary), Grounds, Bonding EPZ Mat, Correct PPE for ARC flash requirements (Reference Versant Power Section 5.3 AF Cheat Sheet)**
2. **Open cutout(s) on pole, and Red tag, test, brush connections and ground.**
3. **Wear rubber gloves and appropriate FR PPE (Clothes, Head and Face Protection) to open door of padmount transformer and verify no visible Primary back feed on transformer and the transformer enclosure is grounded. Persons without appropriate FR PPE must be clear of the ARC Boundary. (Reference Safety Manual Section 5-5.3 AF Cheat Sheet)**
4. **Reference One-Line Diagram to verify Feed(s) match what you are seeing.**
5. **If there is a way to back feed you will need to find the source cutouts to open for de-energizing. Follow the same steps for a Red tag to isolate the underground feed from the source. Open, Red Tag, test, brush connections, and ground at the source.**
6. **Wear rubber gloves and appropriate FR PPE to test secondary voltage is not present. You can do this at the meter or secondary paddles in the padmount transformer.**
7. **Make sure to pull meter and blank off or open meter breaker and install a lock with a Low Voltage Lock Out Tag to make sure you are protected from any customer back feed.**
8. **If working at the padmount transformer, install an EPZ bonding mat to the grounding system to stand on while working. After installing your EPZ work area, your leather gloves are acceptable at this point. (You will need to use rubber gloves until you establish an EPZ work zone)**

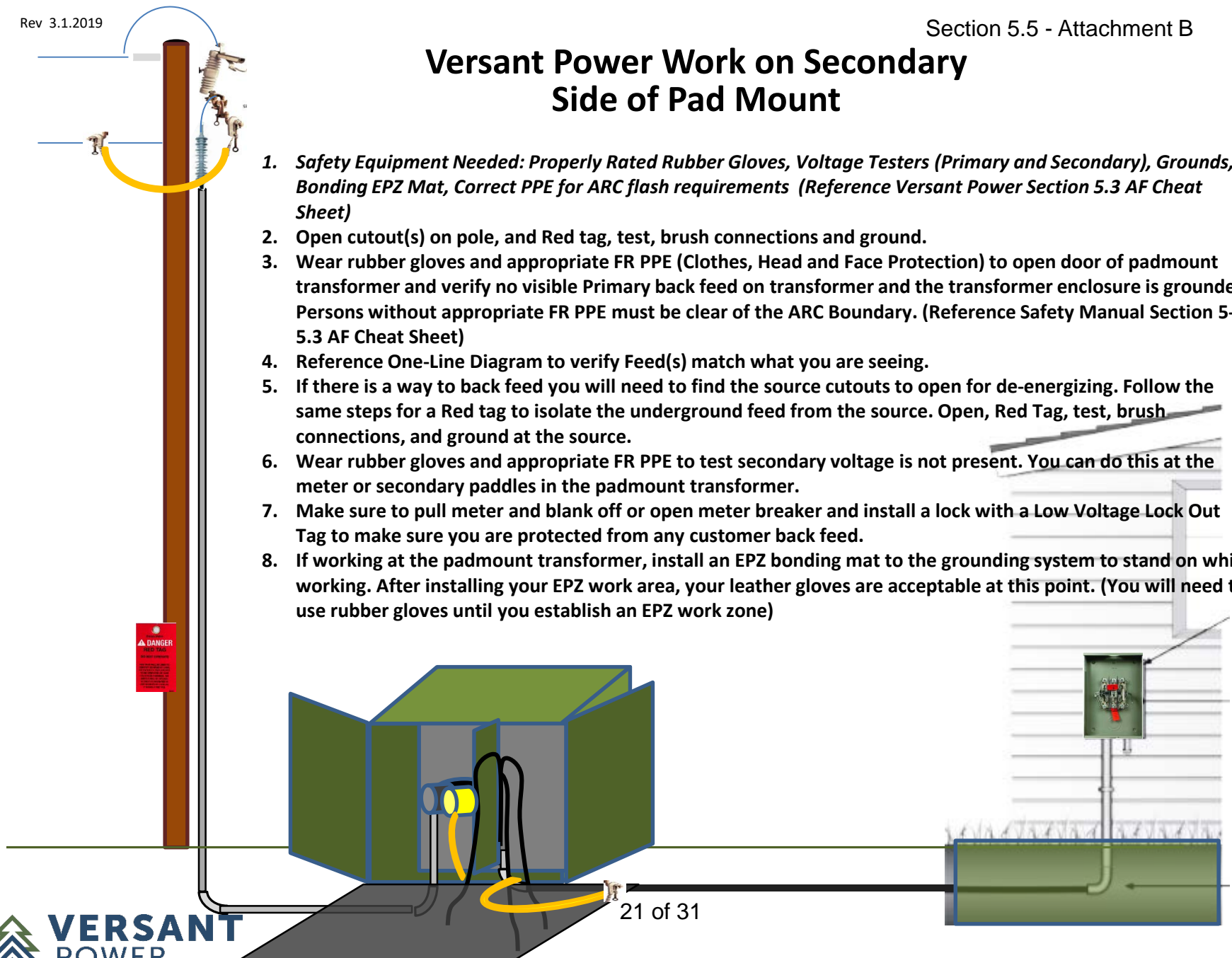

Versant Power Work on New URD and Pad Mount Transformer Install

1. *Safety Equipment Needed: PPE for normal work with no energy source*
2. Has NO ability to be connected to a source you can use leather gloves
3. Megger all new cables BEFORE energizing
4. Connect All secondary connections before making up source end. Versant Power will make all connections to the secondary side of the padmount.
5. When you ground the source of the padmount transformer, you will need to install the EPZ bonding mat to work in the padmount transformer.
6. Once cut out is installed onto a bracket, a red tag and grounds are installed. (Un-tap leads)

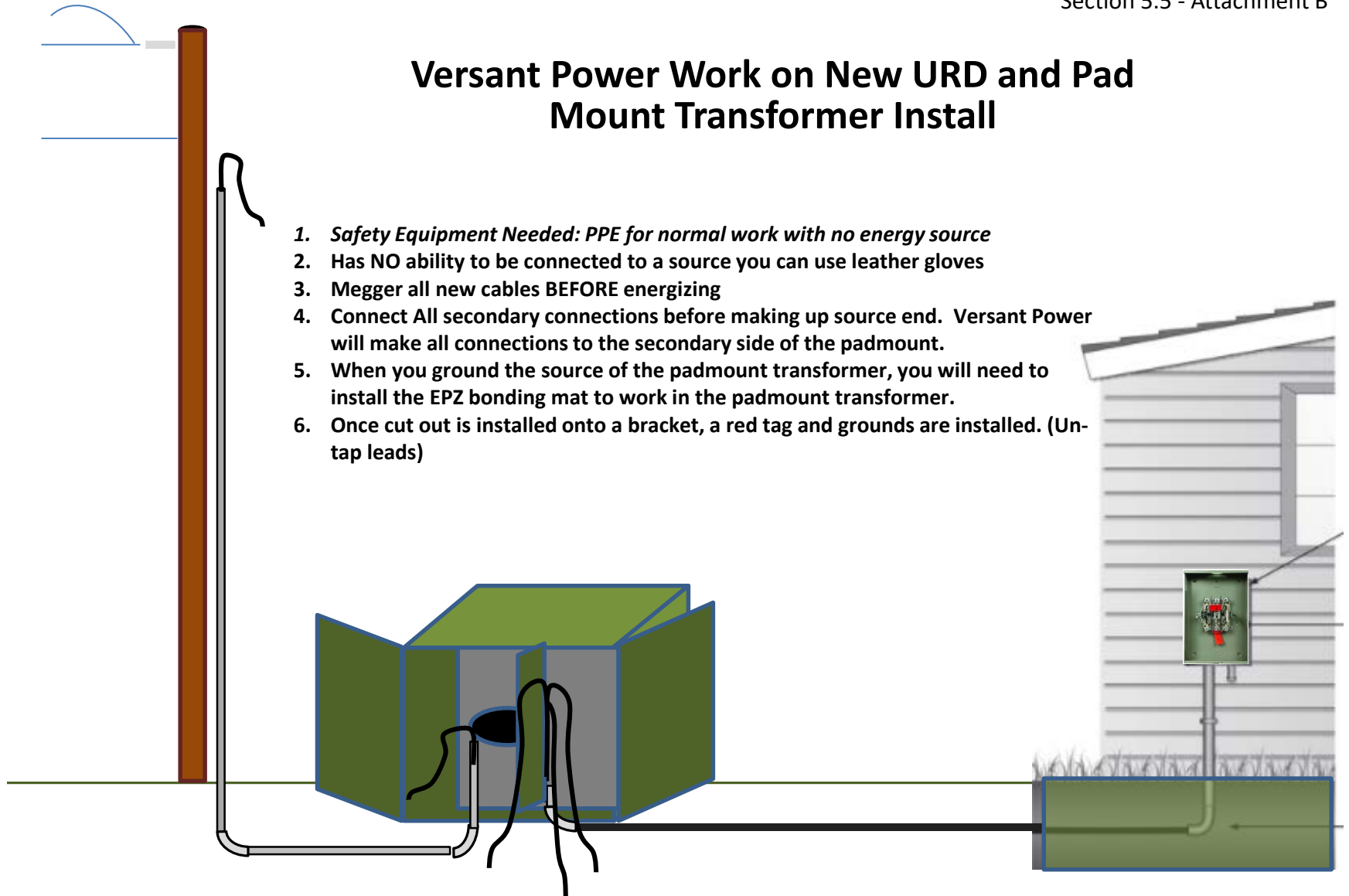

Versant Power to Replace Pad Mount Transformer

1. **Safety Equipment Needed: Properly Rated Rubber Gloves, Voltage Testers (Primary and Secondary), Correct PPE for ARC flash requirements (Reference Versant Power Section 5.3 AF Cheat Sheet), Grounds, Parking Stand(s), Slap Stick Elbow Puller, Shot Gun Stick**
2. Open cutout(s) on pole, red tag, test, brush connections and ground.
3. Wear rubber gloves and appropriate FR PPE (Clothes, Head and Face Protection) to open the door of the padmount transformer and verify no visible back feed on the transformer and the transformer enclosure is grounded. Persons without appropriate FR PPE must be clear of the ARC Boundary. (Reference Safety Manual Section 5-5.3 AF Cheat Sheet)
4. Reference One-Line Diagram to verify Feed(s) match what you are seeing.
5. When working at the padmount transformer you will need to install an EPZ bonding mat to the grounding system. Your work area needs to be at an equal potential.
6. Pull one elbow and install on a (2) way parking stand.
7. Verify Bierer tester is operating properly and set to proper voltage setting. Test voltage by inserting Bierer tester into the second spot on the (2) way parking stand that the elbow is on. Zero volts found move to the next step.
8. After attaching a ground to the padmount ground, install the other end of the ground into the (2) way parking stand just tested at Zero volts.
9. Follow the same steps for testing and grounding other phases if present.
10. With all feeds grounded and the work area EPZ'd you can use leather gloves
11. After removing the padmount neutral you will need to remove the EPZ bonding mat and reinstall it after the new pad-mount's neutral is bonded.

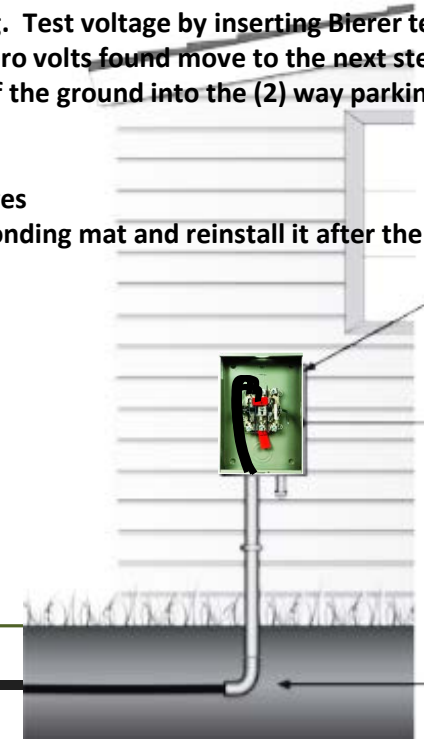
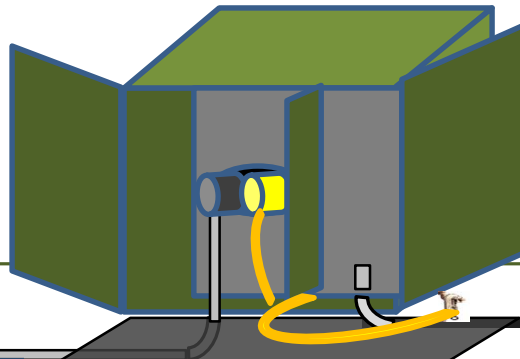
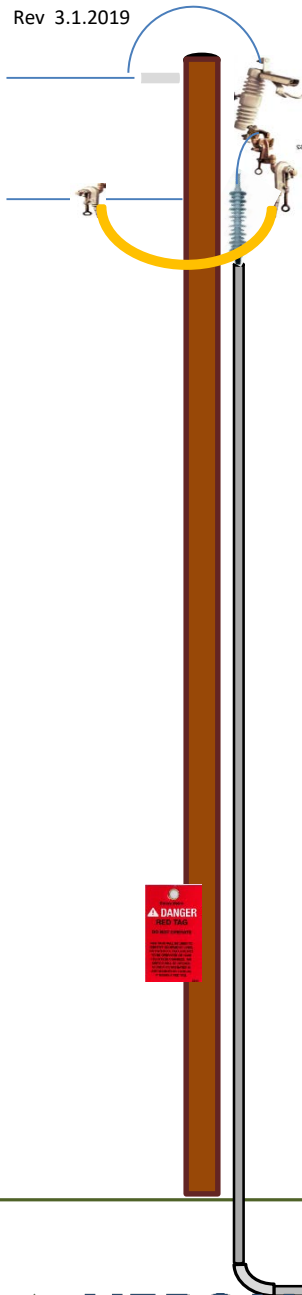

Troubleshooting URD Cables and Pad Mount

1. **Safety Equipment needed:** Grounds for Pole and Padmount, Rubber Gloves, Voltage Tester (Primary), Bonding Blanket, Correct Cal Rated Clothes, Head and Face Protection, (Reference Safety Manual Section 5-5.3 AF Cheat Sheet), (2) Position parking stand, Elbow removing slap- stick, Shot gun stick
2. Open cutout(s) on pole and red tag.
3. Check the area for excavation damage.
4. Wear rubber gloves and appropriate FR PPE (Clothes, Head and Face Protection) to open the door of the padmount transformer and verify no visible back feed on the transformer and the transformer enclosure is grounded. Persons without appropriate FR PPE must be clear of the ARC Boundary. (Reference Safety Manual Section 5-5.3 AF Cheat Sheet).
5. Reference One-Line Diagram to verify Feed(s) match what you are seeing.
6. Pull elbow(s) and install on a 2 way parking stand.
7. Direct contact test with Bierer Tester to confirm no voltage.
8. Brush connections on neutral and ground cable through two-way.
9. Remove ground, install test probe, and ensure integrity of cable by meggar. (Rule of thumb 1 meg per kV.)
10. If primary cable proves to be uncompromised, remove secondary cables and test the padmount transformer.

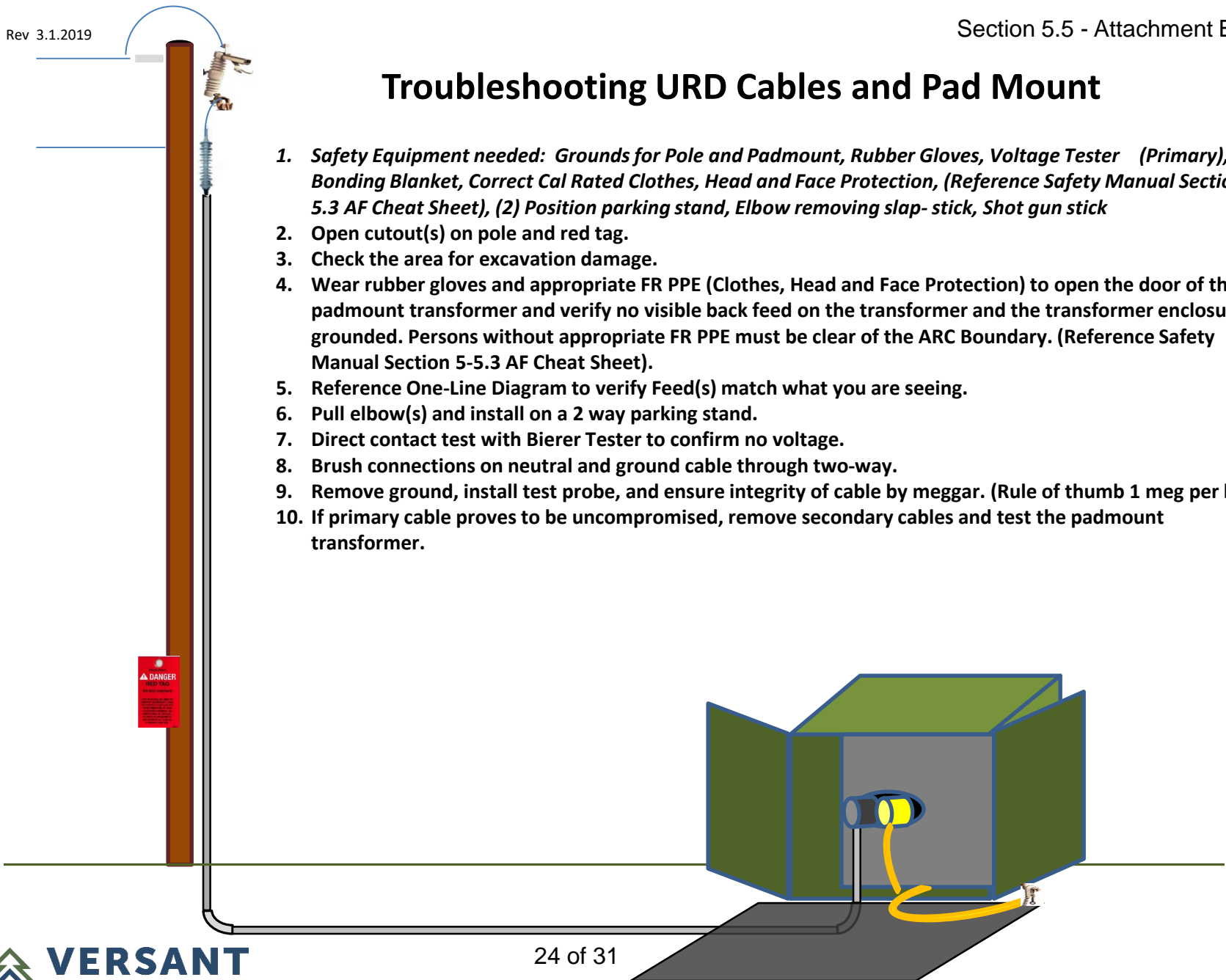

Pad Well Grounding

Review one-line diagram, red tag, test for voltage, brush connections and install grounds at riser termination. A cutout grounding clamp may be used if a ground cannot be installed between the termination and cutout.

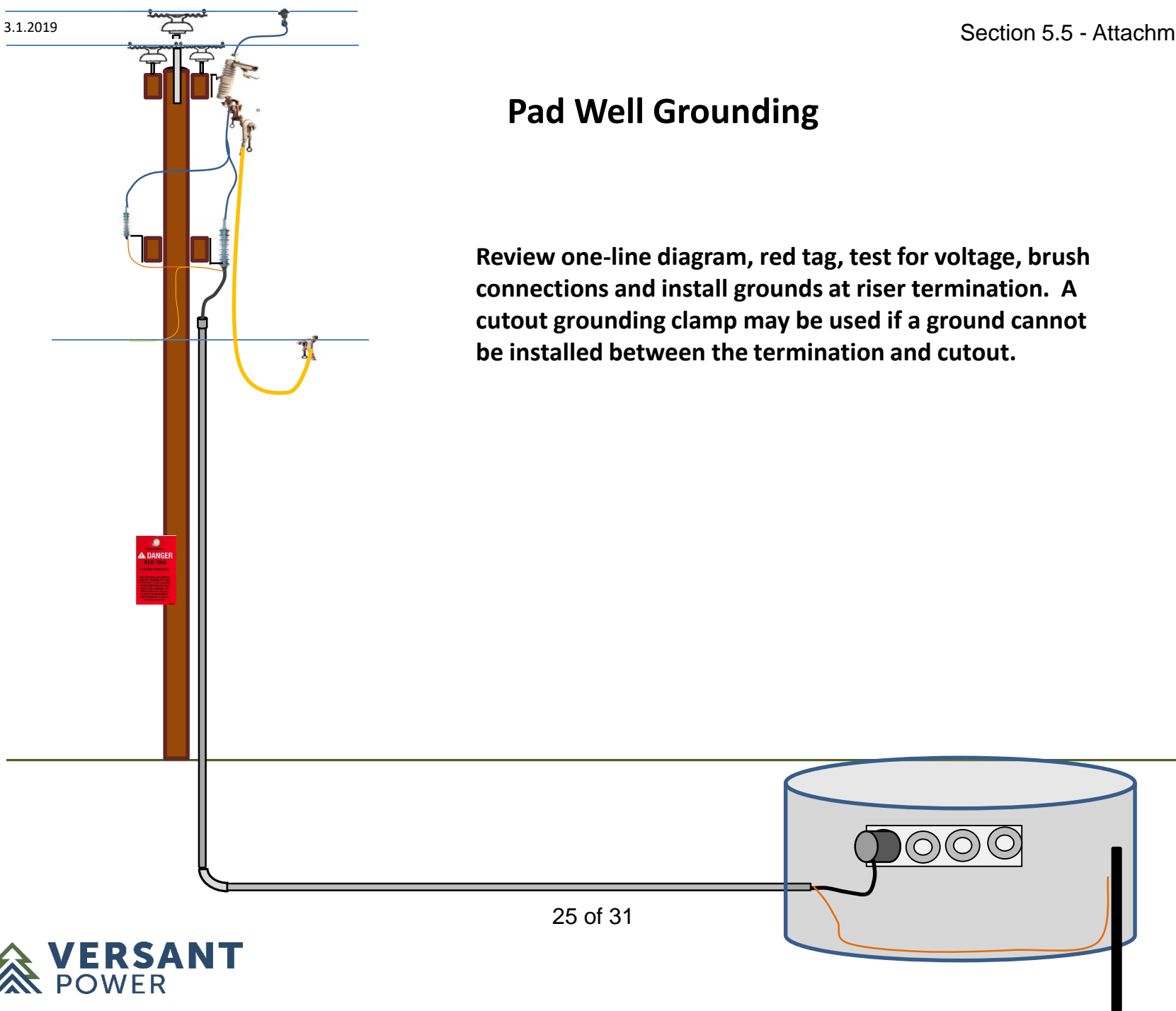

Pad Well Grounding

1. If possible, install an EPZ mat.

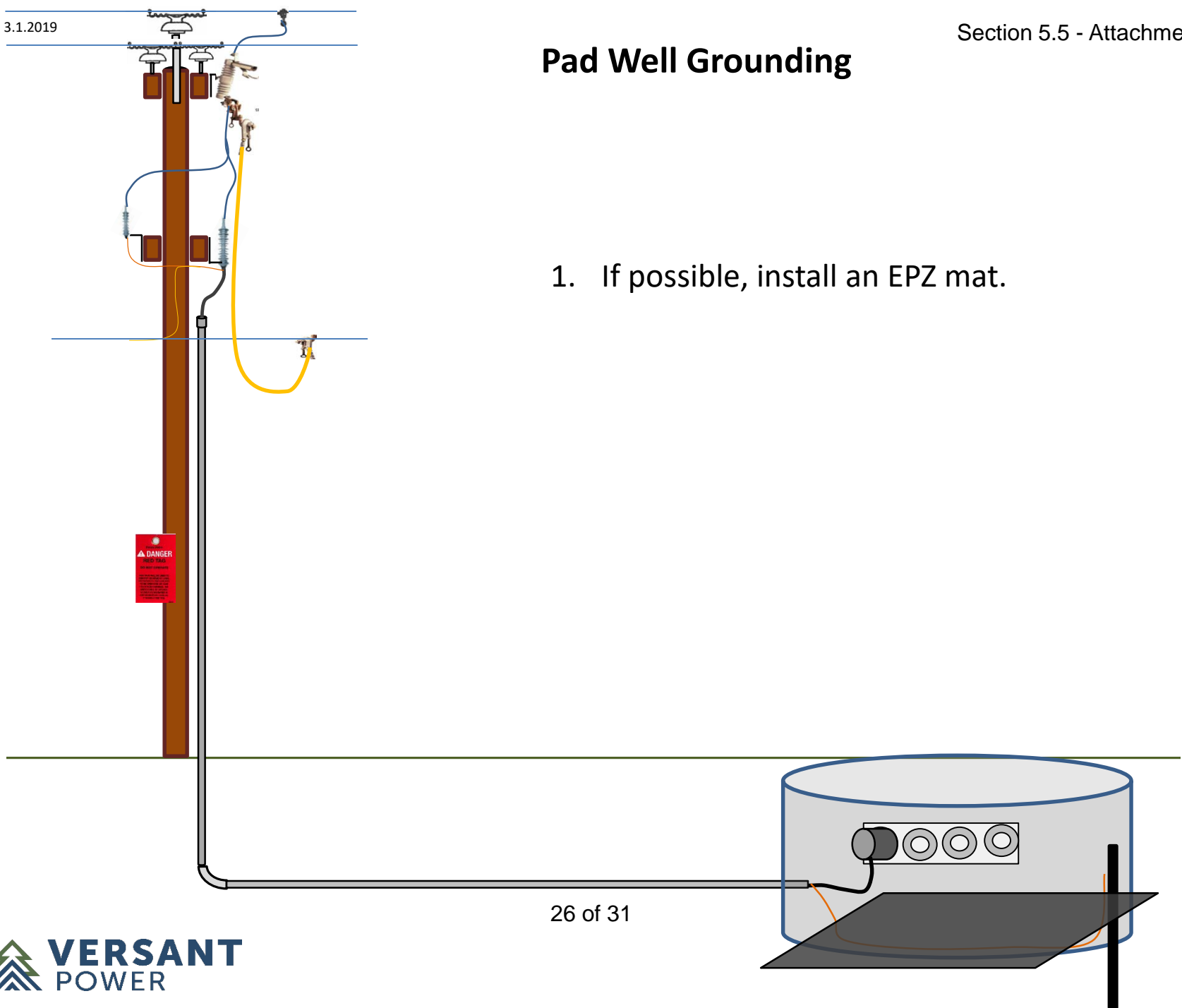

Pad Well Grounding

1. If possible, install an EPZ mat.
2. In a new installation, isolate end of cable to install termination

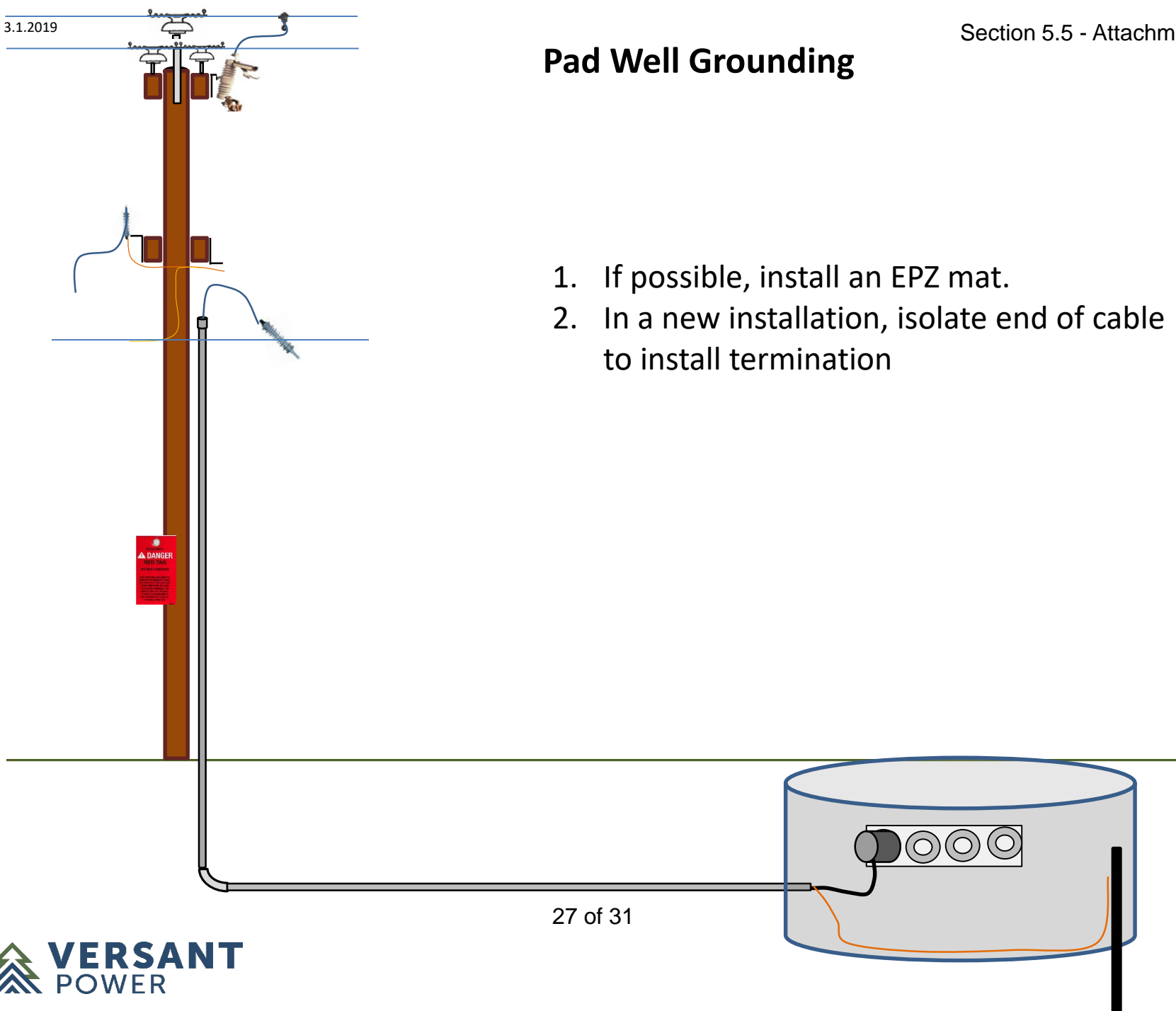

Pad Well Grounding

1. If possible, install an EPZ mat.
2. In a new installation, isolate end of cable to install termination
3. Cover bottom of disconnect and ground to avoid inadvertent closure

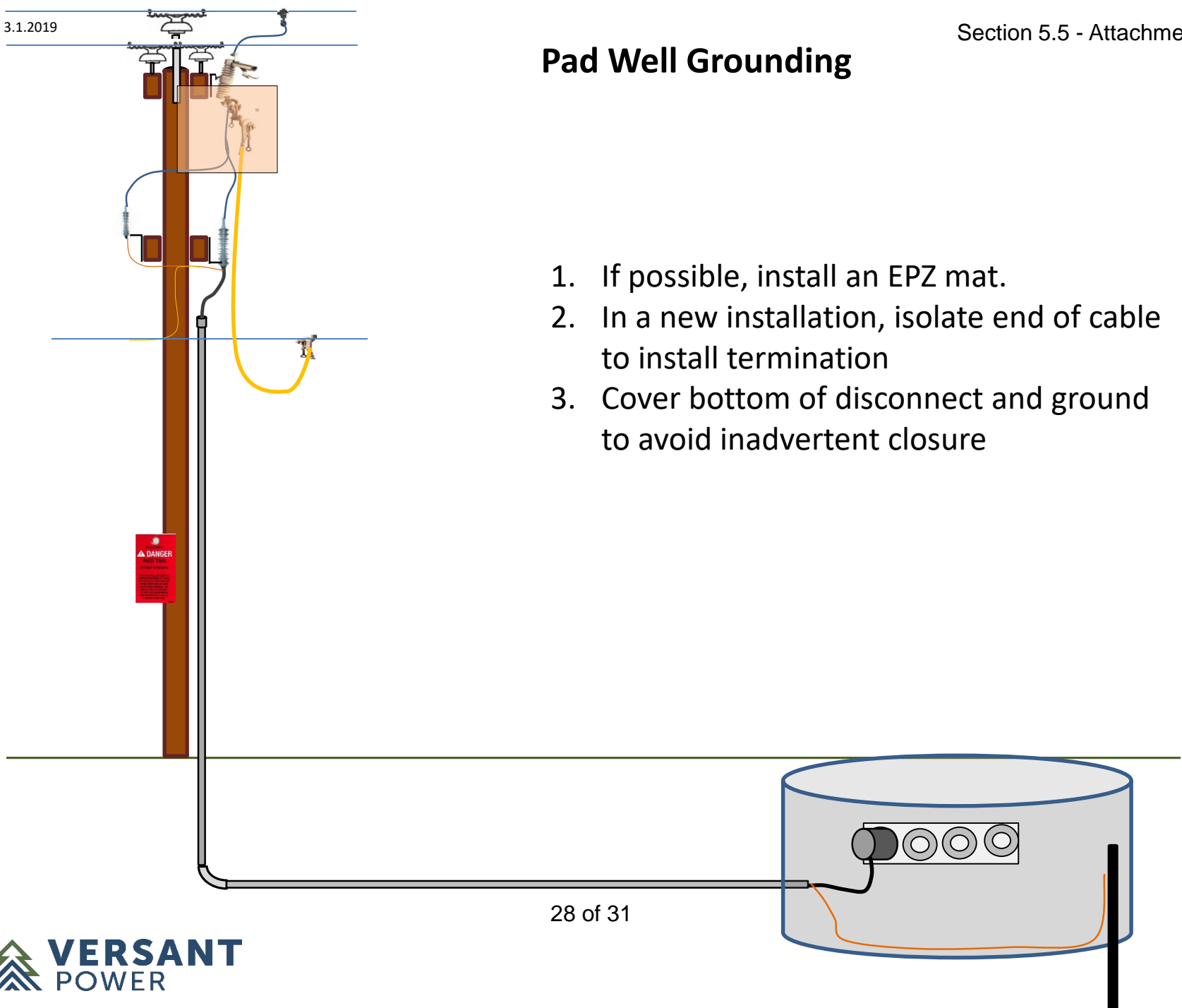

Pad Well Grounding

1. If possible, install an EPZ mat.
2. In a new installation, isolate end of cable to install termination
3. Cover bottom of disconnect and ground to avoid inadvertent closure
4. Double isolation

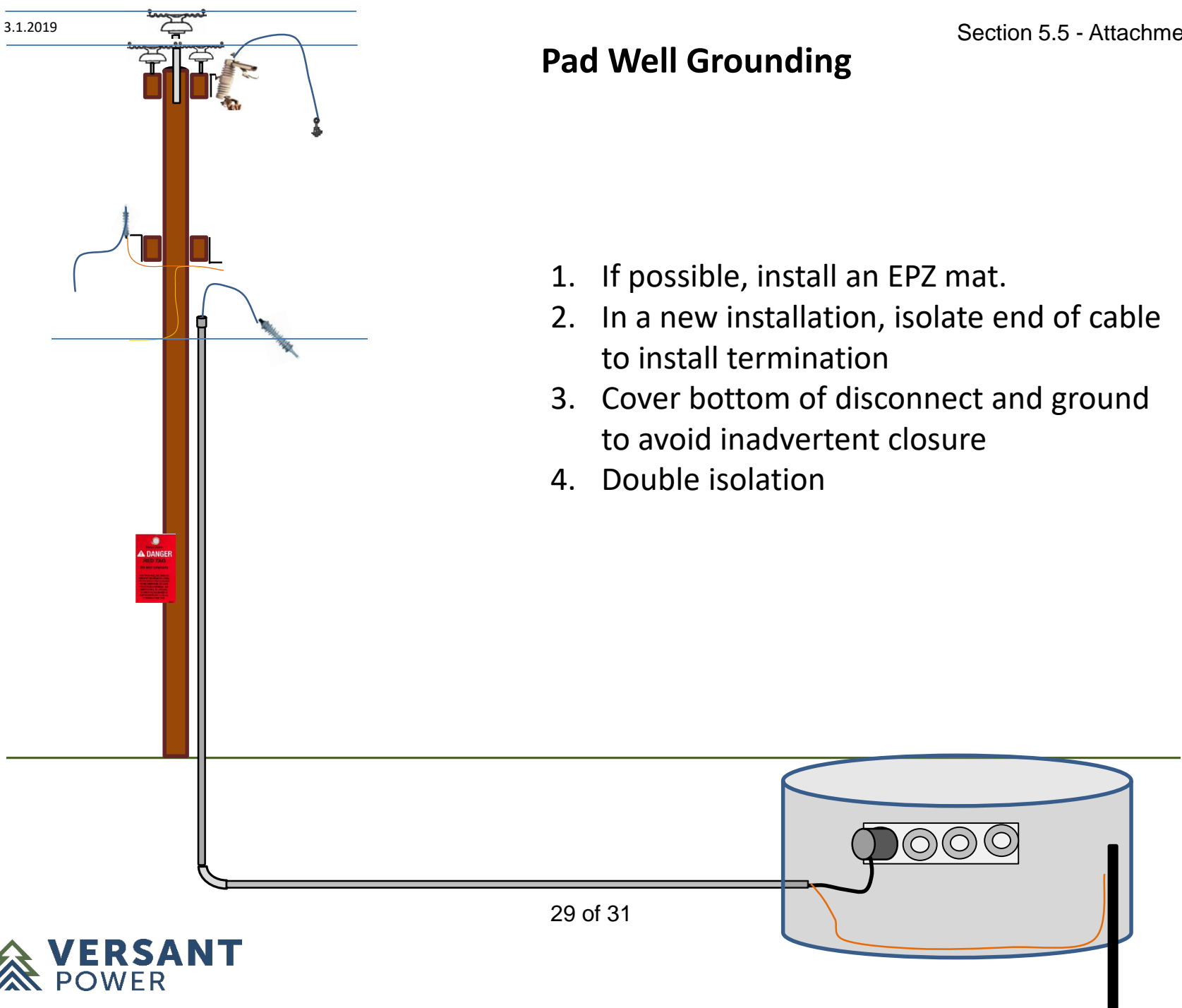

Pad Well Grounding

In the event of troubleshooting a cable failure, remember that both ends of the suspect cable will need to be tested and grounded.

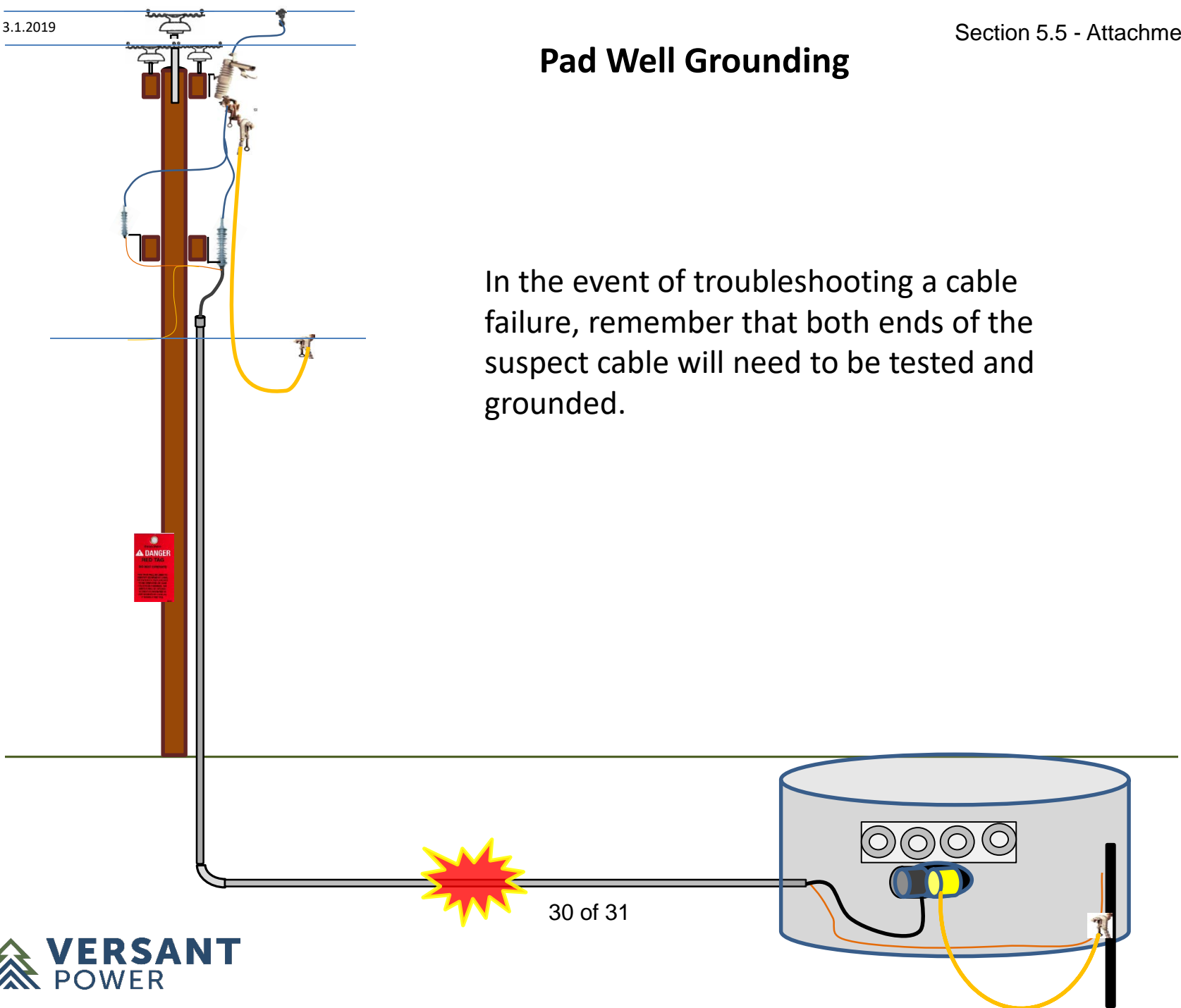

Pad Well Grounding

Direct buried cable will need to have an EPZ mat installed, if possible, at defect for repair.

Joining concentric neutrals should be bonded with a ground; as splicing overhead, separated lines.

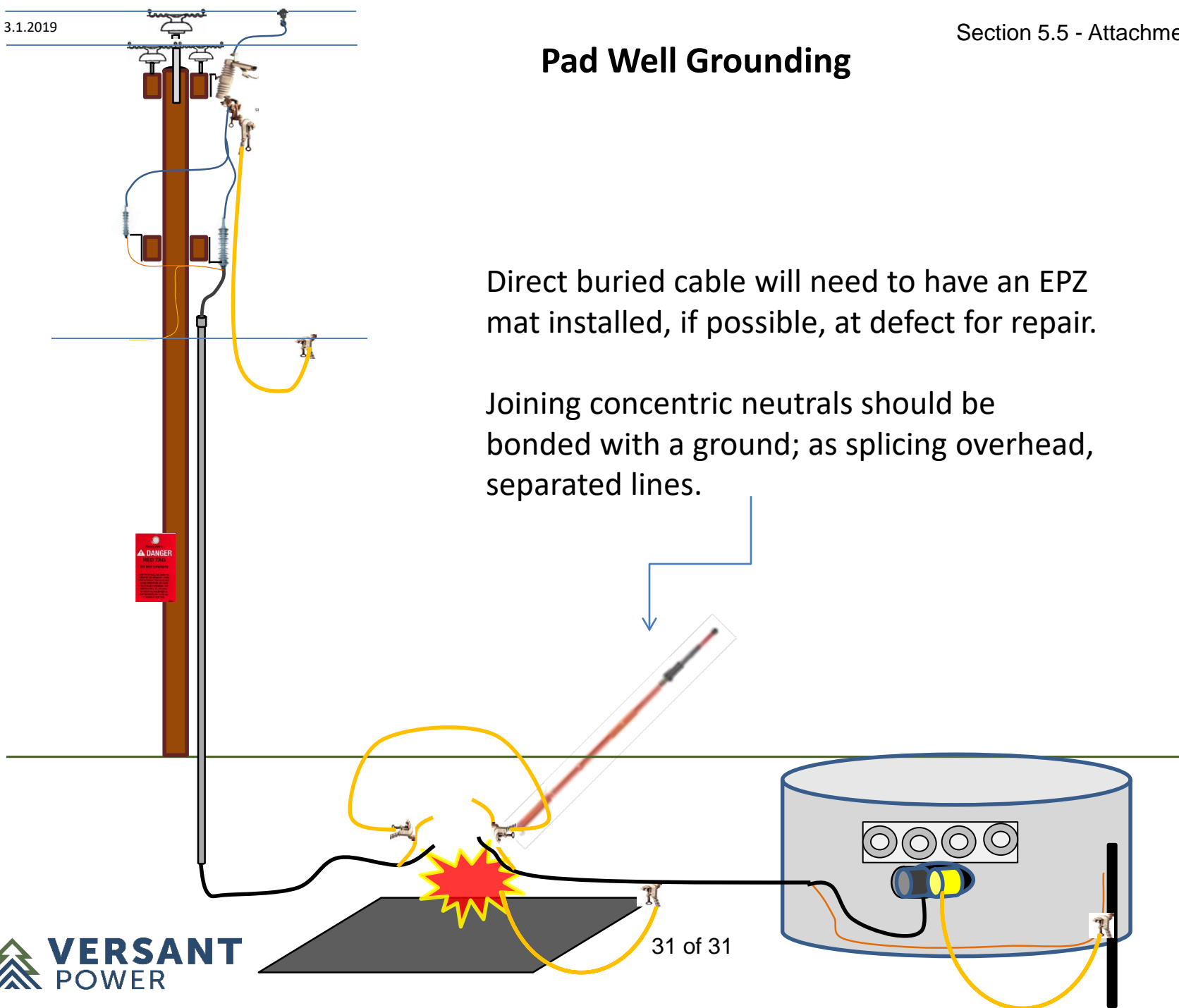

Grounds Testing Policy & Process

Annual Grounds Testing Checklist

Per division all grounds have been tested and marked in the following:

- All Trucks_____
- Facility_____
- Storm Restoration Kits_____
- Wire Trailers_____
- Failed grounds that have been disassembled, cleaned, reassembled and still will not pass but can be salvaged, are returned to the safety lab to be replaced_____.
- Grounds that will not pass and cannot be salvaged are discarded properly in your division_____.
- Checklist completed and sent to the Safety Department_____.
- Facility Name_____.
- Print Name and Date_____.

Section 5	Transmission and Distribution	
5.6	Protective Rubber Goods and Hot-Line Tools	Effective Date: 1/1/2016 Revised: 1/1/2017
5.6.1 Purpose	The purpose of this section is to describe the proper use, care and safety requirements for protective rubber goods and hot-line tools.	
5.6.2 Responsibilities	<ol style="list-style-type: none"> 1. The Company is responsible for providing and maintaining protective equipment. 2. The employee is responsible for using appropriate protective equipment for personal protection. 3. The employee is responsible for the proper care and maintenance of all protective equipment assigned to them. 	
5.6.3 Requirements	<ol style="list-style-type: none"> 1. Rubber Protective Equipment 2. Hot-Line Tools 	
5.6.4 Risk Identification	<ol style="list-style-type: none"> 1. Using defective rubber protective equipment. 2. Serious injury or death caused by electrical contact. 	
5.6.5 Safe Work Practices	<ol style="list-style-type: none"> 1. General <ol style="list-style-type: none"> a. All protective equipment shall be visually inspected prior to use. b. Faulty protective equipment shall not be used and shall be returned to the Safety Test Lab for maintenance or disposal. c. Employees are responsible for properly cleaning, maintaining and storing protective equipment per the manufacturer's instructions. d. Whenever possible, protective equipment should not be stored wet. e. Protective equipment shall not be stored in direct sunlight. f. Petroleum based substances shall be wiped from protective equipment as soon as possible. 2. Rubber Gloves and Sleeves <ol style="list-style-type: none"> a. Rubber gloves shall never be used without approved leather protectors. b. Rubber gloves shall be stored cuff down in the proper storage bag and placed in the truck when not in use. c. Daily rubber glove inspection: <ol style="list-style-type: none"> i. Air-inflated and visually inspected prior to starting daily work. ii. Visually inspected prior to starting each new job. iii. Air-inflated prior to starting each new job if damage is suspected. iv. Check for cuts, tears, nicks and embedded foreign matter. v. Inspect leather protectors for condition and foreign 	

matter.

- d. Rubber gloves shall not be turned inside out at any time.
- e. Damaged, defective, or questionable rubber gloves shall not be used and shall be returned to the Safety Test Lab.
- f. Rubber sleeves shall not be considered a substitute for other protective equipment and must not be relied upon for protection from energized conductors.
- g. Rubber sleeves shall only be considered as additional protection against accidental contact with energized conductors.

3. Cover-up

- a. Before use, inspect cover-up on outside and inside surfaces for cuts, scratches, corona cutting, holes, tears and punctures, aging, rope or wire burns and texture changes such as swelling, softening, hardening, becoming sticky or inelastic.
- b. If mechanical damage extends one quarter of the wall thickness or if there are signs of chemical deterioration the item shall be removed from service.
- c. If cover-up is found to be dirty it shall be cleaned with an approved cleaner prior to use.

4. Insulated (Hot-Line) Tools

- a. Hot-line tools shall be stored in proper compartments at all times.
- b. Before use, hot-line tools shall be wiped clean with an approved cloth and visually inspected for damage or defect.
- c. If any defect is found during inspection, the tool shall not be used. The tool shall be removed from service and sent for repair and testing.
- d. Whenever contaminated, the tool shall be cleaned with an approved product.
- e. Hot-line tools should not be placed on the bare ground.
- f. Clamp jaws should be closed during storage.
- g. Moving parts shall only be lubricated with an approved lubricant.
- h. Hot sticks shall have end caps securely in place to prevent contamination and moisture from damaging the tool.

5. Testing and Maintenance

- a. Rubber gloves shall be tested monthly, regardless of their use.
- b. Rubber sleeves shall be tested every two months.
- c. Cover-up shall be cleaned and tested annually during the vehicles preventative maintenance inspection.
- d. Testing of 34.5 kV and 46 kV hard cover is not required.
- e. Hot-line tools shall be thoroughly inspected, tested and cleaned annually by the Safety Test Lab.
- f. Any hot-line tool failing testing shall be removed from service, thoroughly cleaned and retested.
- g. Repairs to severely damaged hot-line tools shall not be attempted.

	<ul style="list-style-type: none"> h. If protective equipment cannot be repaired, it shall be destroyed. i. Hot-line tools shall be marked with the most recent test date. j. Elastomeric material shall be cleaned with approved cleaning agents and used according to manufacturer's instructions. k. Polyethylene material shall be cleaned as follows: <ul style="list-style-type: none"> i. With an approved cleaner and a non-abrasive cloth when mild contamination is present. ii. With an approved cleaner and an abrasive cloth when heavy contamination is present.
<p>5.6.6 Definitions</p>	<p>Cover-up: cover up includes rubber blankets, line hoses and hard cover.</p> <p>Elastomeric: any material, such as natural or synthetic rubber, that is able to resume its original shape when a deforming force is removed (soft rubber).</p> <p>Hot- Line Tools: an insulated tool fabricated of fiberglass reinforced plastic (FRP), hollow or foam filled that will withstand 100,000 volts per foot of length for five minutes. (This includes shotgun sticks, extendo sticks, tie sticks, switch sticks, cut-out sticks, etc.</p> <p>Polyethylene: a polyether compound with many industrial applications (hard plastic).</p>

Section 5	Transmission and Distribution	
Section 5.7	Working On or Around Energized Equipment	Effective Date: 1/1/2016 Revised: 2/28/21
5.7.1 Purpose	Working on energized equipment is a high risk operation that is routinely performed by employees. This section provides safe work practices for working on energized T&D equipment. <i>If a primary line is not grounded it must be considered energized and all energized work rules and practices will apply.</i>	
5.7.2 Responsibilities	<ol style="list-style-type: none"> 1. The Company is responsible for establishing the safe work practices for working safely on energized equipment. 2. The Company is responsible for providing training to employees who work on the T&D system. 3. The Company is responsible for providing the proper equipment to employees working on the T&D system. 4. Employees are responsible for understanding the hazards of working on the T&D system. 5. The employee is responsible for following the safe work practices while working on the T&D system. 	
5.7.3 Requirements	<ol style="list-style-type: none"> 1. PPE 2. Hot-line tools 3. Proper qualifications 4. Protective Cover-up 	
5.7.4 Risk Identification	<ol style="list-style-type: none"> 1. Electrical contact or arc flash burns resulting in injury or death. 2. Electrical contact due to inadequate use of protective cover. 3. Electrical contact due to incorrect use of PPE or tools. 4. Electrical contact due to high winds when operating aloft 5. Unqualified employees performing work. 6. Falling from heights. 	
5.7.5 Safe Work Practices	<ol style="list-style-type: none"> 1. Rubber Glove Life Saving Rules <ol style="list-style-type: none"> a. Properly rated rubber gloves shall be used when working on energized conductors.(Exceptions as noted in section 5.7.5) 2. Protective Cover Up Life Saving Rules <ol style="list-style-type: none"> a. If working within the mad zone, the energized conductor(s) must be covered. When working on energized conductors, anything at a different potential within reaching distance of the worker - neutral, grounded conductors, guy wires, messenger cables, potential grounds, and pole, etc. shall have approved protective cover-up devices installed. 	

3. General

- a. Work on energized conductors and equipment shall be performed only by qualified employees.
- b. A tailboard briefing and Risk Assessment shall be completed prior to any work being performed on any energized conductor or equipment. Refer to **Section 2.2 Tailboard Briefing and Risk Assessment**.
- c. All conductors and equipment shall be treated as energized unless all of the conditions below have been met:
 - i. There is a visible opening between any primary energizing source and the conductors and equipment.
 - ii. Proper tagging has been applied. Refer to **Section 6 Switching and Tagging**
 - iii. It has been tested to verify the absence of voltage.
 - iv. It has been properly grounded in accordance with **Section 5.5 Protective Grounding**.
 - v. Refer to **Section 5.9 URD Installations** for more information on URD and network systems.
 - vi. The Deviation Protocol located in the Introduction section of this manual shall be used if electrical configurations do not allow this procedure to be completed.
- d. **Isolated Not Grounded (ING)**
 - i. **Any primary ungrounded conductor must be considered energized and all energized work practices and rules will apply. See SWP 5.22 for ING Safe Work Practices**
 - ii. **To perform work on isolated, primary ungrounded lines, a red tag zone of protection needs to be established, with visual openings at the source and all ties to other circuits confirmed open, locked if possible and red tagged. The line should be tested for the absence of voltage before work commences.**
- e. Before commencing work on any conductors or equipment an employee shall be familiar with:
 - i. its function and operation
 - ii. its normal operating voltage
 - iii. whether it will be energized or de-energized
- f. Employees shall not wear jewelry of any kind while working on electrical equipment of any voltage (energized or de-energized). Exceptions to this safe work practice are as follows:
 - i. Electrically or thermally nonconductive jewelry, approved on a case-by-case basis by the Safety Department.
 - ii. Company approved medical bracelets.
- g. When working on energized conductors, choose a safe position from which to work. Do not change position without first

checking for possible hazards.

- h. Employees shall always place themselves in a position to avoid coming into contact with energized conductors in the event of a slip or fall.
- i. Do not lean over or work up through unprotected conductors.
- j. Use caution not to startle an employee while they are working on or near energized conductors or equipment.
- k. Only approved, non-conductive tools shall be used unless the employee is insulated from the energized part.
- l. Tools shall not be handled by or passed between employees who are at different voltage potentials unless both employees are wearing properly rated rubber gloves.
- m. Weather-proof or tree-resistant material on a conductor shall not be considered electrical protection.
- n. The spans on each side of the pole on which work is to be done shall be checked for safe clearance of trees, buildings, etc. before untying and changing the position of any conductors.
- o. Employees shall notify System Operations prior to patrolling a transmission line and then immediately upon finishing the patrol.

4. Use of Rubber Gloves

- a. Rubber gloves shall never be used without approved leather protectors. When rubber gloves are used they must be rated for the voltage being worked on or around. See table at end of section 5.7.5 2
- b. A minimum of Class 2 rubber gloves shall be worn while working on conductors and equipment energized above 1000V.
- c. Daily rubber glove inspection:
 - i. Air-inflated and visually inspected prior to starting daily work.
 - ii. Visually inspected prior to starting each new job.
 - iii. Air-inflated prior to starting each new job if damage is suspected.
- d. Rubber gloves shall be worn at all times while an employee is working within reach of the MAD zone.
- e. Ground to Ground Rule: When intending to work on energized conductors and equipment with hands or hot-line tools, rubber gloves shall be worn from the time the aerial lift leaves the cradle until the aerial lift returns to the cradle.
- f. When clearances permit, the following exceptions may be made to the Ground to Ground Rule:
 - i. Leather gloves may be worn when climbing a pole until the worker is at the space tag or 40 inches below the neutral. Above that point, rubber gloves shall be worn.
 - 1. Employees shall carry rubber gloves on their person at all times when climbing a pole.
 - ii. Changing out bulbs and photo cells on area or street lights. This requires cut resistant gloves.

- iii. Making adjustments or repairs to regulators or capacitor control equipment or secondary wiring associated with primary metering equipment.
- iv. Testing with insulated test leads or operating insulated test switches and equipment operating at a nominal voltage of 480 volts or below.
- v. When making terminations on energized poles, provided these steps are followed:
 1. All energized equipment shall be properly covered.
 2. The conductor is measured and then brought to a position where the worker cannot reach any energized primary conductors before gloves are removed.
- vi. When changing taps in transformers, after all exposed energized wires are properly covered and the transformer is completely disconnected from both the primary and secondary circuits.
- vii. When working energized lines 34.5 kV and above with insulated sticks if there are no distribution lines underneath.
- g. Rubber gloves shall be worn when operating air break switches, cutouts and disconnects from the ground. They also need to be worn when operating metal clad disconnects/ground switches. However, leather work gloves may be used in place of rubber gloves when a worker is using an extendo-stick from the ground, provided the stick is extended and has a tag indicating the stick has been electrically tested within the past 12 months.
- h. Rubber gloves do not need to be worn when coupling or decoupling a motor operator from a switch.
- i. Rubber gloves shall be worn while placing personal protective grounds with hot-line tools.
- j. Only employees qualified and trained in 19.9/34.5 kV rubber gloving may perform this work.
- k. 19.9/34.5 kV rubber gloving is limited to the process of skinning covered conductors.
- l. Rubber glove work on the neutral of an energized primary circuit shall be permitted from a pole or bucket up to 19.9/34.5 kV. Use appropriate class gloves per table below.
- m. At a minimum, low voltage rubber gloves shall be used on equipment energized at 1000 volts or less.
- n. Rubber gloves shall be worn while installing or removing socket watt-hour meters with glass or plastic covers.
- o. Rubber glove work on any energized overhead primary conductor or equipment shall not be done from a ladder or from any grounded structure or platform.
- p. Energized underground primary cable can be handled with rubber gloves providing the concentric neutral is intact and there

is no risk of entering the MAD zone of any exposed energized conductors.

ASTM D120 Class Specifications for Insulating Rubber

Class	Proof Test Voltage	Max Use Voltage	Label Color
Class 00	2,500 AC/10,000 DC	500 AC/750 DC	Beige
Class 0	5,000 AC/20,000 DC	1,000 AC/1,500 DC	Red
Class 1	10,000 AC/40,000 DC	7,500 AC/11,250 DC	White
Class 2	20,000 AC/50,000 DC	17,000 AC/25,500 DC	Yellow
Class 3	30,000 AC/60,000 DC	26,500 AC/39,750 DC	Green
Class 4	40,000 AC/70,000 DC	36,000 AC/ 54,000 DC	Orange

5. Use of Rubber Sleeves

- a. Rubber sleeves shall only be considered additional protection against unintended contact.
- b. Intentional contact between energized equipment and rubber sleeves shall be not be permitted.
- c. Rubber sleeves shall be worn on the exterior of all clothing and on the inside of the rubber glove cuffs.
- d. Rubber sleeves shall be worn when the following tasks are performed on energized primary voltage conductors:
 - i. splicing conductor
 - ii. dead-ending conductor
 - iii. connecting or disconnecting taps or tails that are not secured.
 - iv. installing or removing preformed grips or armor rods
 - v. working in the MAD zone of any three-phase junction pole
- e. Rubber sleeves may also be worn in other situations as required by the employee-in-charge. Sleeves should be worn when there is a risk of the upper arms or shoulders contacting energized parts that are in the area of the line or equipment being worked.

6. Use of Hot-Line Tools

- a. Only Company approved and tested hot-line tools shall be used.
- b. Only hot-line tools of the proper voltage and mechanical strength rating shall be used.
- c. Hot-line tools of the proper length shall be used to maintain a position beyond the ability to reach into the MAD. For MAD distances see **Section 5.4 Minimum Approach Distances**.
- d. Hot line tools should not contact any part of the body except the hands while in use.
- e. Conductors should be visually inspected for damage prior to using hot-line tools.
- f. Work on an energized primary conductor from a pole shall be done with hot line tools.
- g. Ropes used on energized conductors shall be insulated with link

sticks.

7. Work on Energized Conductors and Equipment

a. General

- i. Rubber glove work on energized conductors and equipment shall not be done in inclement weather (snow, rain) unless required under emergency conditions and can be performed safely.
- ii. Neutral conductors underneath an energized circuit shall be considered energized and should be covered with rubber protective devices before beginning work.
- iii. Ground conductors on poles should be adequately covered before work is started.
- iv. When conductors and equipment are to be energized, connect the neutral first.
- v. When conductors and equipment are to be de-energized, disconnect the neutral last, if necessary.
- vi. Ground conductors should be examined to see that the connections are not corroded and that the grounds are effective.
- vii. Jumpers, used as a tool on energized conductors or equipment, must be approved, rated for the voltage, & tested by the safety lab (annually)
- viii. A jumper shall be installed if it is necessary to cut the ground or neutral conductor when working on energized conductors or equipment.
- ix. When temporarily disconnecting taps/tails for non-tagging purposes, tape may be used to secure taps & tails.

b. Lighting Arrestors

- i. When installing lightning arrestors, always connect the neutral terminal first.
- ii. When removing lightning arrestors, disconnect the neutral terminal last.
- iii. Lightning arrestors shall be energized (connected) with hot-line tools.

c. Capacitors

- i. All tanks and metal hangers for capacitor banks shall be effectively grounded.
- ii. Before working on capacitors they shall be disconnected from energized sources for at least five minutes, then short circuited across each terminal with a piece of wire attached to a hot-line stick.
- iii. Short circuiting may produce a spark or flash. Keep away, guard your face and wear eye protection.
- iv. Capacitors shall be disconnected from the energized source, short circuited and grounded to be considered de-energized.
- v. Any line to which capacitors are connected shall be

- grounded before being considered de-energized.
- vi. Each capacitor unit shall be grounded between all insulated terminals and the tank before handling.
- d. Distribution Transformers
 - i. All transformers shall be connected in accordance with the applicable construction standards.
 - ii. A transformer shall be completely disconnected before replacement or internal repair is attempted.
 - iii. The transformer tank ground shall be the first connection made and the last connection removed.
 - iv. The secondary voltage shall be checked before connection to a customer is completed.
 - v. When working on banked transformers, the primary leads shall be disconnected to prevent back feed.

8. Use of Protective Cover-Up

- a. Protective cover-up shall only be considered as additional protection against accidental contact.
- b. Protective cover-up shall be inspected before each use for possible damage and defects.
- c. Protective cover-up shall be installed where an employee could accidentally come in contact with any **ungrounded primary conductor or any** energized conductor or equipment.
- d. Protective cover-up shall be installed with rubber gloves, or hot sticks if applicable.
- e. Protective cover-up shall be used at the voltages for which they are rated.
- f. Protective cover-up should be applied with the lineman's eye level at or below the conductors, and the conductors nearest shall be covered first. When removed, the reverse order shall be observed.
- g. Employees shall be aware of their position at all times to avoid accidental contact with protective cover-up.
- h. Intentional contact between employees and protective cover-up shall not be permitted.
- i. If working within the mad zone, the energized conductor(s) must be covered. When working on energized conductors, anything at a different potential within reaching distance of the worker - neutral, grounded conductors, guy wires, messenger cables, potential grounds, and pole, etc. shall have approved protective cover-up devices installed.
- j. Reaching distance shall be considered the greatest distance the employee can reach with arms and fingers fully extended, plus the additional length of any conductive material or equipment being handled.
- k. If protective cover-up could move or become dislodged it shall be fastened to prevent it from slipping out of place.

	<p>9. Opening/Closing Circuits</p> <ul style="list-style-type: none"> a. When opening or closing circuits, single phasing of three-phase customers shall be avoided. b. Under normal operating conditions, opening and closing of circuits should be completed by the recloser or nearest disconnect switch. c. Distribution non-loadbreak cutout fuses rated 15 amps or less are not required to use a loadbreak tool for voltages less than 15 kV. Other non-loadbreak fuses or disconnects shall be opened with an approved loadbreak device or de-energized before opening. d. Hot taps shall not be used to pick up or disconnect load. e. Jumpers shall not be used to pick up or disconnect load. f. A hot-line stick shall be used when opening or closing a cutout. g. When de-energizing cutouts for an extended period of time, the cutout doors shall be removed and hung on the pole. h. Manual switches and disconnects shall be opened or closed by a continuous motion. i. When expulsion type fuses are being installed, employees shall wear eye protection and stand clear of the exhaust path. Hearing protection should also be used. j. Lines up to 10 spans in length with no load and clear line of sight that have been patrolled, may be energized/de-energized with a hot stick and hot line clamp, or with a mechanical jumper. Lines that do not meet these criteria require a BREAK-SAFE® Tool or a cutout to energize/de-energize.
<p>5.7.6 Definitions</p>	<p>Armor Rod: Stranded preformed wire rods that are wrapped on existing conductors & designed to protect cable against bending, compression, abrasion, and flash-over. They are also used to repair damaged aluminum-based conductors and restore the conductors' mechanical strength and conductivity.</p> <p>Cover-up: cover up includes rubber blankets, line hoses and hard cover.</p> <p>Employee-in-charge: the employee who has been designated foreman or the lead worker assigned responsibility for the specific job.</p> <p>Energized:</p> <ul style="list-style-type: none"> 1. Electrical: Connected to a source of potential, or electrically charged so as to have a potential different from that of earth ground. 2. Pneumatic & Hydraulic: Under pressure different from that of atmosphere. 3. Mechanical & Potential: Not at rest, retaining a charge. <p>Hot- Line Tools: an insulated tool fabricated of fiberglass reinforced plastic (FRP), hollow or foam filled that will withstand 100,000 volts per foot of length for five minutes. (This includes shotgun sticks, extendo sticks, tie sticks, switch sticks, cut-out sticks, etc.</p>

Isolated Not Grounded (ING): This refers to primary electrical conductors that have been disconnected from energy source(s) via open switch, breaker, disconnect, etc. but NOT grounded. ING Safe Work Practices are detailed in SWP 5.22. Key to SWP 5.22 is understanding that any primary ungrounded conductor must be considered energized and all energized work rules apply. Additionally, any work done on ING primary conductors requires a red tag zone of protection be established.

Junction Pole: any pole that has a primary line breaking off from the main line, whether single or three phase.

Section 5	Transmission and Distribution	
Section 5.8	Poles and Pole Handling	Effective Date: 1/1/2016 Revised: 9/1/2019
5.8.1 Purpose	Electric utility pole operations pose significant hazards to workers when climbing, handling, transporting and setting. Therefore, this section provides safe work practices when conducting these operations.	
5.8.2 Responsibilities	<ol style="list-style-type: none"> 1. The Company is responsible for providing the proper training and equipment. 2. Employees shall report promptly to their supervisor any unsafe poles, structures and installations. 3. Employees shall report any damage or defects noted in a pole yard. 	
5.8.3 Requirements	<ol style="list-style-type: none"> 1. Digger-derricks 2. Fall Protection 3. PPE 4. Pole Handling Tools 5. Cover-up 	
5.8.4 Risk Identification	<ol style="list-style-type: none"> 1. Serious injury caused by electrical contact. 2. Public safety around work zones. 3. Improper lifting and setting techniques resulting in equipment and property damage or personal injury. 4. Improperly used or defective fall protection causing the employee to fall from a pole. 5. Personal injury or equipment damage caused by unsecured poles in the pole yard. 	
5.8.5 Safe Work Practices	<ol style="list-style-type: none"> 1. General <ol style="list-style-type: none"> a. When handling treated poles, employees shall wear proper PPE to avoid skin and eye contact with the preservative. b. Employees shall not stand between the pole and the loading or transporting equipment when loading a pole. c. After removing a pole from the pole pile, employees shall ensure that all remaining poles are secure on the pile and are not likely to roll off. d. All pole butts within road limits shall be removed from the ground and properly disposed of. The hole shall be properly filled and tamped. e. Pole butts outside of road limits should be removed or cut off at ground level. f. When loading, unloading, or handling poles make sure ropes, tackle, chains and slings are in good condition and are of adequate size and strength. 	

- g. Employees handling poles shall work at the ends whenever possible.
- h. When cutting/removing/wrecking out transmission poles refer to SWP 7.01 which covers potential fumigant hazards.
- i. When handling/storing/installing composite utility poles refer to SWP 5.15 for guidance.

2. Pole Setting

- a. No excavation shall be conducted until a Dig Safe ticket has been submitted and approved, all relevant utilities have been notified and their facilities located.
- b. Poles shall be supported by digger derrick or by other means when trenching disturbs soil adjacent to the pole.
- c. Insulated pole guards and/or insulating cover-up are required if the pole being handled may come into contact with any energized lines or parts or the pole or digger are in the mad zone. Refer to SWP 5.04 Setting Poles in Energized Conductors.
- d. Before setting poles through or within the MAD zone of lines energized at 19.9/34.5 kV or higher voltages, Yellow Tag clearance shall be obtained. Refer to **Section 6.6 Yellow Tag**.
- e. Rubber gloves shall be worn at all times by employees while handling poles when they might come in contact with energized conductors.
- f. Insulated pole tongs or cant dogs shall be used with rubber gloves when handling poles set through within the MAD zone of energized conductors above 15 kV. If gloves rated for the available voltage are used, insulated pole tongs or cant dogs are not needed.
- g. The butt of the pole should remain in contact with the ground during setting operations.
- h. When piking poles, hold the pike pole to the side of the body and not in front.
- i. Following the setting, replacement or removal of poles, disturbed soil shall be properly tamped to a level not less than the adjacent ground.
- j. Open pole holes shall never be left unguarded. Any open pole hole left unguarded shall be covered completely or filled in.
- k. A qualified line worker shall be able to set a pole near energized lines with appropriate supervision from a 1st Class Line Worker as described in **Section 5.1 Attachment A**.

3. Pole Climbing

- a. Employees are not permitted to climb poles alone. Refer to **Section 5.2 Working Alone** for additional information.
- b. Employees required to climb poles shall be formally trained and certified for pole top rescue annually.
- c. Employees shall wear approved fall protection in accordance with the manufacturer's instructions when climbing or working from a pole or structure. Refer to **Section 2.10 Fall Protection**.

	<ul style="list-style-type: none"> d. Employees shall wear long sleeved shirts and long cuffed gloves when climbing poles. e. Long-cuffed leather gloves shall be worn when climbing an energized pole until the worker is at the space tag or 40 inches below the neutral. Above that point, rubber gloves shall be worn. f. Employees shall not wear loose clothing while climbing poles. g. Employees shall be aware of signs, staples, nails or other debris that could puncture gloves while climbing. h. Employees shall remove rigid signs or other non-Company approved attachments from poles prior to climbing. i. Employees shall carry rubber gloves on their person at all times when climbing an energized pole. j. Poles shall be tested before climbing is attempted. Testing of poles should include: <ul style="list-style-type: none"> i. physical condition ii. depth and condition of setting iii. integrity at ground level iv. strains that may exist or may be added as a result of the work to be done v. the condition of all fixtures and attachments k. Employees shall not climb poles that are determined to be unsafe. l. Before climbing, poles may be secured by: <ul style="list-style-type: none"> i. lashing the pole to a truck derrick ii. lashing the pole to a new and sound pole iii. using temporary guys m. Employees shall stay a safe distance from the top of the pole, to avoid belting over the pole. n. Employees shall only strap fall protection to the pole. Fall protection shall not be attached to insulator pins, crossarm braces, brackets, and similar pole attachments.
<p>5.8.6 Definitions</p>	<p>Cant Dogs: a logging tool consisting of a handle with a moveable hook used for turning poles.</p> <p>Cover-up: cover up includes rubber blankets, line hoses and hard cover.</p> <p>Composite Utility Pole: a manufactured pole typically constructed of fiberglass or other plastic resin materials. Also known as FRP poles (Fiber Reinforced Polymer). These poles have different handling and framing requirements than wood poles.</p> <p>Dig Safe: a clearing house that notifies participating utility companies of planned digging activities.</p> <p>Digger-Derrick: a specialized type of equipment equipped with augers to drill holes and with a hydraulic boom to lift, designed to install utility poles.</p>

	<p>Piking: process of using a piking tool.</p> <p>Pole Tongs: a tool used to grab and guide poles.</p> <p>Space Tag: a tag affixed to a pole that marks the beginning of the electrical pole space.</p>
--	--

Section 5	Transmission and Distribution	
5.9	URD Installations	Effective Date: 1/1/2016 Revised: 1/1/2017
5.9.1 Purpose	Underground power lines are not visible and therefore pose a different set of hazards than overhead lines. This section provides information and safe work practices when working with underground power lines.	
5.9.2 Responsibilities	<ol style="list-style-type: none"> 1. The Company is responsible for providing employee training on constructing and maintaining underground power lines. 2. The Company is responsible for developing a process for identifying and labeling underground systems. 3. Employees are responsible for following the safe work practices. 	
5.9.3 Requirements	<ol style="list-style-type: none"> 1. PPE (including FR and AR clothing) 2. Appropriate Tools 3. One line diagrams, if available 	
5.9.4 Risk Identification	<ol style="list-style-type: none"> 1. Serious injury caused by electrical contact. 2. Public safety around work zones. 3. Moving traffic around work zones. 4. Damaging underground utilities with heavy machinery. 5. Trench cave-in resulting in personal injury or death. 	
5.9.5 Safe Work Practices	<ol style="list-style-type: none"> 1. General <ol style="list-style-type: none"> a. Pumps used for de-watering enclosures containing energized cables or apparatus should be equipped with non-conductive hoses. b. Cables shall be secured in a safe manner to prevent accidental tripping or injury. c. If possible, the cable to be worked on shall be grounded on both ends and at the work location. d. When making terminations on radial underground cables fed from energized poles or manholes, the following shall be completed prior to starting work: <ol style="list-style-type: none"> i. Visible opening shall be verified at the source. ii. Appropriate tagging shall be applied to the cable. iii. Cable shall be tested for the absence of voltage. iv. The load side of the cutout, if installed, shall be grounded. v. When the above conditions have been met, the cable can be terminated without being grounded once employee and equipment are clear from the MAD zone. vi. For other installations where this procedure cannot be followed, refer to the deviation protocol located in the Introduction section of this manual. 	

- e. Be aware that a capacitance charge can remain in a URD cable after it has been disconnected from the circuit and a static-type arc can occur when grounds are applied.
- f. When multiple cables are located in a work area, electrical tests shall be used to identify the cable to be worked.
- g. All cables and equipment shall be labeled in accordance with the Company's Construction Standard 2215.
- h. Do not remove or alter labels without proper approvals.
- i. Prior to entering any underground structure more than five feet deep a Confined Space Entry Permit shall be completed. Refer to **Section 2.12 Confined Space Entry Policy** for more information.
- j. Gas insulated equipment (sulphur hexafluoride) shall not be operated unless the equipment gas pressure is within recommended limits.
- k. Refer to **Section 5.3 Arc Flash** for information on arc flash PPE.
- l. Refer to **Section 2.14 Excavation and Trenching** for information on excavation and trenching.

2. Opening/Closing

- a. Company switching and tagging procedures shall be followed when performing work on underground systems. Refer to **Section 6 Switching and Tagging**.
- b. Load break elbows should not be used to energize or de-energize a load.
- c. Underground primary circuits should be energized or de-energized with a fused cutout or properly rated switchgear.
- d. When underground cable or equipment has faulted, the section of line which appears to be in trouble shall be patrolled for any obvious dig-ins or above-ground hazards before the circuit is re-energized.
- e. If the first re-energization attempt is not successful, further troubleshooting shall be done before another attempt is made.

3. Rubber Glove Use

- a. Rubber gloves shall be worn before any underground compartment or enclosure (including a service pedestal) is opened. Rubber gloves may be removed once the enclosure is opened and verified to be grounded.
- b. Rubber gloves shall be worn at all times when working with primary underground cables unless the cable is de-energized, tagged, tested and grounded. For installations where this procedure cannot be followed refer to the deviation protocol located in the Introduction section of this manual.
- c. Rubber gloves can be removed for the following exceptions
 - i. Fault locator battery change
 - ii. Infrared inspections
 - iii. Installing new URD cable that has not been connected to a source.

	<ul style="list-style-type: none"> iv. Other tasks of similar nature d. Rubber gloves shall be worn when using hand tools to excavate or expose energized primary cables. e. Rubber gloves shall be worn when energized cables, including underground primary cable with concentric neutrals, are moved, handled or covered-up. f. Rubber gloves shall be used while making energized secondary connections. <p>4. Work on Energized Equipment</p> <ul style="list-style-type: none"> a. Before a transformer enclosure is opened, all unauthorized persons shall leave and remain clear of the arc boundary. Refer to <u>Section 5.3 Arc Flash</u> for more information. b. When energized pad-mounted transformers are unlocked and opened, they shall be attended by a qualified employee. They shall be kept closed and locked at all other times. c. When work is performed on cables or equipment carrying less than 600 volts, employees shall be aware of exposed energized parts such as secondary bushings and connecting blocks. d. Before moving energized cables, carefully inspect them for defects. e. Only one energized secondary or service conductor shall be worked on at time and protective equipment should be used to insulate or isolate it from all others.
<p>5.9.6 Definitions</p>	<p>Load Break Connections: An underground electrical connection that can be removed while energized.</p> <p>URD: Underground Residential Distribution</p>

Section 5	Transmission and Distribution	
5.10	Meter Operations	Effective Date: 1/1/2016 Revised: 1/1/2017
5.10.1 Purpose	Meter operations work poses many risks due to unforeseen hazards. This section provides information on proper care when working on or around meters.	
5.10.2 Responsibilities	<ol style="list-style-type: none"> 1. The Company is responsible for ensuring only qualified employees work on meters and associated equipment. 2. The employee is responsible for the proper care and maintenance of all protective equipment assigned to them. 3. The employee is responsible for using all appropriate protective equipment for meter operations. 	
5.10.3 Requirements	<ol style="list-style-type: none"> 1. PPE 2. Meter test equipment 	
5.10.4 Risk Identification	<ol style="list-style-type: none"> 1. Serious injury caused by electrical contact. 2. Serious injury cause by an arc flash. 3. Dangerous or aggressive people or animals causing personal injury. 	
5.10.5 Safe Work Practices	<ol style="list-style-type: none"> 1. General <ol style="list-style-type: none"> a. If a meter enclosure is found to be unsafe, report it as a hazardous condition and notify the appropriate supervisor. If there is an immediate safety concern, notify Central Dispatch and then de-energize. b. New meter installations that do not meet company standards shall not be worked on. c. All overhead line work in conjunction with meter work shall be performed by a qualified line worker under the direct supervision of a qualified meter tester and installer. d. Install the correct meter taking into consideration the class/form of the meter. e. Report theft or tampering with meters by completing a Field Employee Observation Report. http://intra.versantpower.com//resources/forms/FieldEmployeeObservationChecklist.cfm f. Refer to Section 2.11 Ladders and Scaffolding for information regarding ladder safety. g. Refer to Section 2.8 Personal Protective Equipment for information on wearing hard hats. h. Refer to Section 5.3 Arc Flash for required arc rated PPE, including face shields and balaclava. i. Approved safety glasses shall be worn under the following conditions: 	

- i. installing or removing meters
- ii. testing meters in shop or field
- iii. disassembling, re-assembling and cleaning meters
- j. Insulated tools shall be used when working on energized meter enclosures and equipment.
- k. Only company supplied voltmeters shall be used.
- l. When voltage is in question, voltmeters shall be set on the highest scale to prevent personal injury or equipment damage.
- m. Before entering, always make your presence known to the occupants of the premises.
- n. Exercise care when entering basements or electrical rooms. Look for defective stairs, nails, tripping hazards, drain holes, low beams, low over-head projections and other hazards.
- o. Employees shall use reasonable care and foresight to avoid confrontation.
- p. Do not enter any unoccupied premises unless specific arrangements have been made.
- q. Be aware of animals, insect nests and overgrown vegetation.
- r. Equipment shall be de-energized when handling fuses or open-blade switches.

2. Testing Meters

- a. Only standard potential leads provided with proper fuse protection shall be used when making up meter test connections.
- b. Meter testers shall be careful to connect only one jumper at a time.
- c. Before connecting test leads, jumpers or test devices, meter testers shall ensure that the free end is clear.
- d. When connecting test loads or other test equipment, make sure that all connections have been made to the equipment before the source is connected.
- e. Test instrument connections shall not be opened or shifted while the test load is connected.
- f. Refer to **Section 5.10 Attachment A** for meter testing and equipment procedures.

3. Self-Contained Meters

- a. Eye protection, low voltage rubber gloves and FR/AR clothes shall be worn when installing or removing meters.
- b. At a minimum, low voltage rubber gloves shall be worn at or below 600 volts when setting, removing or testing for voltage, short circuits or grounds in single or polyphase self-contained meters.
- c. Visually check that the meter socket is in serviceable condition and is safe to work on.
- d. Prior to meter installation, the meter socket shall be tested for source, back-feed and ground on all self-contained installations. If improper voltage is found, do not proceed until the problem is

corrected.

- e. Checks shall be performed on transformer rated installations of secondary voltage to ensure the conductors are not cross phased or grounded on either the line or load side of the current transformers. On installations with padmounted transformers or other primary voltage sources the cross phase and ground checks shall be performed on the secondary conductors prior to energizing.
- f. Do not use manual bypass devices to make or break load. Use a load breaking device if load cannot be shed. Note: Class 320 (400 amp) meters are particularly hazardous due to the higher capacity level.
- g. Maintain proper footing and stand to one side while installing or removing meters.
- h. Make initial contact with load terminals first then contact line terminals before seating fully in jaws.
- i. All energized meter sockets without a meter shall be covered with a blank cover and locked when left unattended.
- j. The meter installer is responsible for recognizing potential hazards. Hazards of particular concern are:
 - i. Meter enclosures that have broken line side lugs.
 - ii. 277/480 volt meters have increased arc-fault capability.
 - iii. Meters with broken glass shall be removed by using the meter pullers if the meter cannot be de-energized.
 - iv. Broken meters should be placed in an appropriate transport container.
 - v. Cut proof gloves shall be used when handling *glass.

4. Transformer Rated Meters

- a. Follow meter standards for metering applications, unless a deviation is approved by the PST Department and Engineering Department.
- b. Before work is done on any metering equipment or switch gear, a voltage check shall be made.
- c. Checks shall be performed on transformer rated installations of secondary voltage to ensure the conductors are not cross phased or grounded on either the line or load side of the current transformers. On installations with padmounted transformers or other primary voltage sources the cross phase and ground checks shall be performed on the secondary conductors prior to energizing.
- d. New primary metering installations shall be worked on one end at a time with the meter end completed first, unless all the primary circuits at the work location have been de-energized, tagged and properly grounded.
- e. Before opening or changing the secondary connection of current

	<p>transformers, the secondary circuit of the transformer shall be short-circuited or de-energized.</p> <ul style="list-style-type: none"> f. The secondary winding of a current transformer shall never be opened while the primary is energized, as dangerously high voltage can be induced in the secondary winding. g. If the primary of the current transformer cannot be de-energized before working on the current transformer secondary circuit, bridge the circuit to the source side of the work area to avoid an open circuit. h. Do not short the secondary circuit of a voltage transformer while the transformer is energized. i. If the primary of the voltage transformer cannot be de-energized before working on the voltage transformer secondary circuit, open the circuit to the source side of the work area to prevent a short circuit.
<p>5.10.6 Definitions</p>	

Self-Contained, Single-Phase Socket Meter, up to 400 amps

A. Source Voltage Check - Voltage Scale (Figure 1)

Place Probes on:

1 and 2	240V ±
2 and N	120V ±
N and 1	120V ±

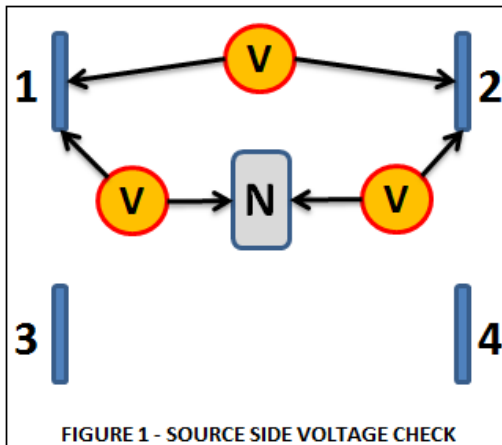

B. Backfeed Voltage Check - Voltage Scale (Figure 2)

Place Probes on:

3 and 4	0V*
4 and N	0V*
N and 3	0V*

* Trace amounts of voltage permissible. Higher voltage present indicates a backfeed situation and **DO NOT** set the meter and report to Supervisor and **DO NOT** attempt the Short Circuit Test.

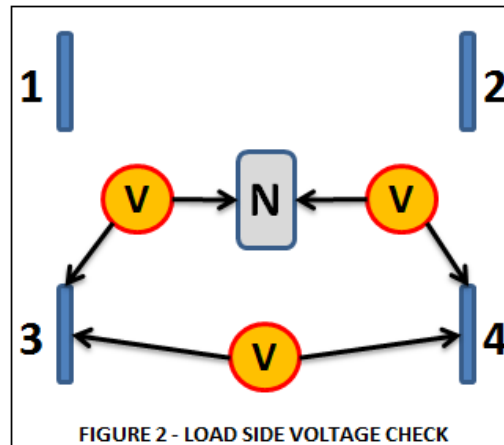

C. Load Side Short Circuit Check - OHMS Scale With Main Disconnect Open

Place Probes on:

3 and 4	"OL"*
4 and N	"OL"*
N and 3	"OL"*

* Reading may be in the Meg-OHMS range, but if the reading is in the K-OHMS range or lower, especially near "0", then reading indicates a short circuit and **DO NOT** set the meter and report to Supervisor.

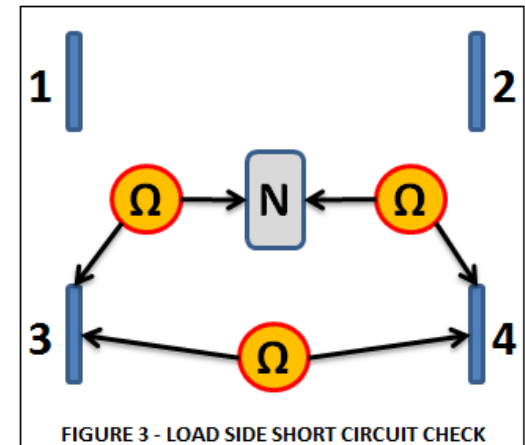

Self-Contained, Three-Phase Socket Meter, up to 400 amps

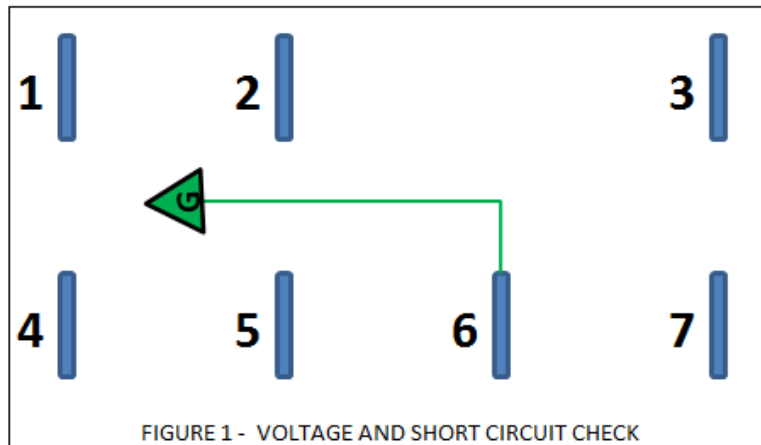

A. Source Voltage Check – Voltage Scale

Place Probe on:

- 1 and 2 = 208 V +/- (480)
- 2 and 3 = 208 V +/- (480)
- 3 and 1 = 208 V +/- (480)
- 1 and 6 = 120 V +/- (277)
- 2 and 6 = 120 V +/- (277)
- 3 and 6 = 120 V +/- (277)

B. Backfeed Voltage Check - Voltage Scale

NOTE: Customer's disconnect device must be closed and the by-pass must be open (down) prior to conducting the following tests:

Place Probes on:

- 4 and 6 = 0*
- 5 and 6 = 0*
- 6 and 7 = 0*
- 4 and 5 = 0*
- 4 and 7 = 0*
- 5 and 7 = 0*

* Trace amounts of voltage permissible. Higher voltage present indicates a backfeed situation and **DO NOT** set the meter and report to Supervisor and **DO NOT** attempt the Short Circuit Test.

C. Load Side Short Circuit Check - OHMS Scale

NOTE: Customer's disconnect device must be open and the by-pass must be open (down) prior to conducting the following test.

Place Probes on:

- 4 and 5 = "OL"*
- 5 and 7 = "OL"*
- 7 and 4 = "OL"*
- 4 and 6 = "OL"*
- 5 and 6 = "OL"*
- 7 and 6 = "OL"*

* Reading may be in the Meg-OHMS range, but if the reading is in the K-OHMS range or lower, especially near "0", then reading indicates a short circuit and **DO NOT** set the meter and report to Supervisor.

Three-Phase, Four-Wire Delta Socket Meter, up to 400 amps

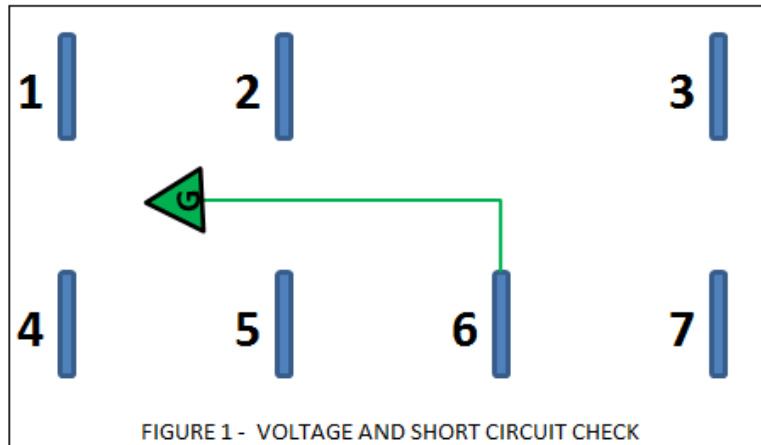

A. Source Voltage Check – Voltage Scale

Place Probe on:

- 1 and 2 = 240 V +/-
- 2 and 3 = 240 V +/-
- 3 and 1 = 240 V +/-
- 1 and 6 = 120 V +/-
- 2 and 6 = 120 V +/-
- 3 and 6 = 208 V +/-

B. Backfeed Voltage Check - Voltage Scale

NOTE: Customer's disconnect device must be closed and the by-pass must be open (down) prior to conducting the following tests:

Place Probes on:

- 4 and 6 = 0*
- 5 and 6 = 0*
- 6 and 7 = 0*
- 4 and 5 = 0*
- 4 and 7 = 0*
- 5 and 7 = 0*

* Trace amounts of voltage permissible. Higher voltage present indicates a backfeed situation and **DO NOT** set the meter and report to Supervisor and **DO NOT** attempt the Short Circuit Test.

C. Load Side Short Circuit Check - OHMS Scale

NOTE: Customer's disconnect device must be open and the by-pass must be open (down) prior to conducting the following test.

Place Probes on:

- 4 and 5 = "OL"*
- 5 and 7 = "OL"*
- 7 and 4 = "OL"*
- 4 and 6 = "OL"*
- 5 and 6 = "OL"*
- 7 and 6 = "OL"*

* Reading may be in the Meg-OHMS range, but if the reading is in the K-OHMS range or lower, especially near "0", then reading indicates a short circuit and **DO NOT** set the meter and report to Supervisor.

Three-Phase, Three-Wire Delta Socket Meter, up to 200 amps

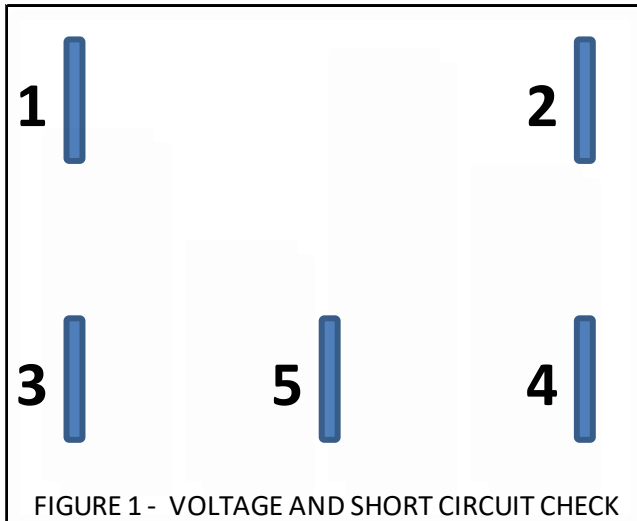

A. Source Voltage Check – Voltage Scale

Place Probe on:

- 1 and 2 = 240 V +/- (480)
- 1 and 5 = 240 V +/- (480)
- 2 and 5 = 240 V +/- (480)

B. Backfeed Voltage Check - Voltage Scale

NOTE: Customer's disconnect device must be closed and the by-pass must be open (down) prior to conducting the following tests:

Place Probes on:

3 and 4 = 0*

5 is solid Bus, always hot!

* Trace amounts of voltage permissible. Higher voltage present indicates a backfeed situation and **DO NOT** set

the meter and report to Supervisor and **DO NOT** attempt the Short Circuit Test.

C. Load Side Short Circuit Check - OHMS Scale

NOTE: Customer's disconnect device must be open and the by-pass must be open (down) prior to conducting the following test.

Place Probes on:

3 and 5 = "OL"*

4 and 5 = "OL"*

3 and 4 = "OL"*

* Reading may be in the Meg-OHMS range, but if the reading is in the K-OHMS range or lower, especially near "0", then reading indicates a short circuit and **DO NOT** set the meter and report to Supervisor.

Three-Phase, Three-Wire Network Socket Meter, up to 400 amps

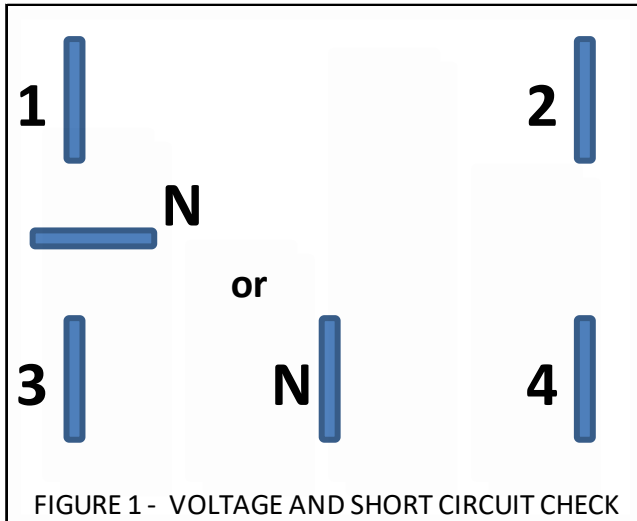

FIGURE 1 - VOLTAGE AND SHORT CIRCUIT CHECK

A. Source Voltage Check – Voltage Scale

Place Probe on:

1 and 2 = 208 V +/-

2 and N = 120 V +/-

N and 1 = 120 V +/-

B. Backfeed Voltage Check - Voltage Scale

NOTE: Customer's disconnect device must be closed and the by-pass must be open (down) prior to conducting the following tests:

Place Probes on:

3 and N = 0*

N and 4 = 0*

3 and 4 = 0*

* Trace amounts of voltage permissible. Higher voltage present indicates a backfeed situation and **DO NOT** set

the meter and report to Supervisor and **DO NOT** attempt the Short Circuit Test.

C. Load Side Short Circuit Check - OHMS Scale

NOTE: Customer's disconnect device must be open and the by-pass must be open (down) prior to conducting the following test.

Place Probes on:

3 and 4 = "OL"*

4 and N = "OL"*

N and 3 = "OL"*

* Reading may be in the Meg-OHMS range, but if the reading is in the K-OHMS range or lower, especially near "0", then reading indicates a short circuit and **DO NOT** set the meter and report to Supervisor.

Section 5	Transmission and Distribution	
5.11	Substations	Effective Date: 1/1/2016 Revised: 1/1/2018
5.11.1 Purpose	Substations contain high voltage energized equipment in close proximity to workers. This section provides safe work practices for employees while performing work inside substations.	
5.11.2 Responsibilities	<ol style="list-style-type: none"> 1. The Company is responsible for providing proper training to work in or around substations. 2. Employees are responsible for following the safe work practices when working in or around substations. 	
5.11.3 Requirements	<ol style="list-style-type: none"> 1. PPE 2. Qualified Personnel 	
5.11.4 Risk Identification	<ol style="list-style-type: none"> 1. Serious injury or death caused by electrical contact. 2. Personal injury caused by equipment failure. 3. Unqualified employee being unattended while in a substation. 4. Employee and public safety hazard if fence grounds have been tampered with. 	
5.11.5 Safe Work Practices	<ol style="list-style-type: none"> 1. General <ol style="list-style-type: none"> a. System Operations shall be notified when an employee enters or leaves a substation. b. Check for signs of break in or vandalism before entering a substation. Ensure grounds and neutrals are properly installed. c. If grounds or neutrals are missing or questionable, wear rubber gloves when touching the substation fence. d. When adequate line of sight cannot be established between employees and the entrance gate, the gate shall be properly secured. e. Unqualified persons shall be accompanied by a qualified employee at all times when inside a substation. f. Storage of materials and equipment in substations shall be per NESC 110B which limits combustibles, dust, and fumes among other criteria. g. At a minimum, all persons shall wear the following PPE when entering any substation: <ol style="list-style-type: none"> i. Hard Hat ii. Safety Glasses iii. Protective Footwear per Section 2.8.5 4 Foot Protection iv. Apparel as required by Section 5.3 Arc Flash h. When employees enter a substation where work is being performed the onsite employee-in-charge shall be notified. The entering employee shall receive a tailboard briefing from the 	

- employee-in-charge and then sign onto the daily Risk Assessment.
- i. When switching lines and equipment refer to **Section 6 Switching and Tagging**.
 - j. Refer to **Section 5.5 Protective Grounding** for information on personal protective and equipment grounding.
 - k. Upon completion of work on de-energized lines and equipment and prior to energization, the tag holder shall ensure that all employees are clear, protective grounds removed and all tags removed.
 - l. When a substation fence must be expanded or removed, a temporary fence shall be installed and properly grounded if the substation is to be left unattended.
 - m. For more information on mobile substations refer to **Section 5.12 Mobile Substations**.

2. Working in Control Houses

- a. Work on or around energized control panels shall only be performed by qualified employees.
- b. All control wiring on the back of control and RTU cabinets shall be considered energized.
- c. Employees working on or around low voltage panel-boards shall install barriers to prevent accidental contact with live parts.
- d. Control fuses shall be handled with fuse pullers insulated for the voltage rating of the fuse.
- e. Blown fuses shall be replaced with fuses of the same voltage and amperage rating.

3. Battery Rooms

- a. Safety goggles, face shield, chemical rubber gloves and approved coverall suit shall be worn by employees handling acid or lead acid batteries.
- b. Batteries shall be maintained per the manufacturer's guidelines.
- c. Battery spills shall be cleaned up following the appropriate SDS guideline.
- d. Battery rooms shall have adequate ventilation to ensure diffusion of the gases from the battery and to prevent the accumulation of an explosive mixture.
- e. Introducing any source of ignition in a battery storage area is prohibited unless it has been approved by the supervisor and the room has been adequately ventilated.
- f. Employees shall take necessary precautions while handling energized battery parts. Employees shall use insulated tools when working on or around energized batteries.
- g. Eyewash stations shall be located in the vicinity of indoor battery storage rooms. Refer to **Section 2.13 Eyewash Stations**.
- h. Portable eyewash stations shall be available when working on outdoor substation battery installations.
- i. Vent caps shall be installed on all batteries, except during

	<p>transport.</p> <p>j. For more information on acid refer to Section 7.4 Acid.</p> <p>4. Working in Substation Yard</p> <p>a. Caution shall be exercised when handling materials in the vicinity of energized equipment.</p> <p>b. Personal protective grounds may be removed for testing purposes only.</p> <p>c. Only qualified employees shall use or supervise the use of specific vehicles, cranes, etc.</p> <p>d. Mobile cranes and digger-derricks shall be grounded when being operated in close proximity to energized lines or equipment.</p> <p>i. When the equipment is in the MAD zone, the MAD zone distances will apply to all employees working in the vicinity of the equipment.</p> <p>ii. All employees within the MAD zone of the equipment shall wear rubber gloves. Refer to Section 5.4 Minimum Approach Distances.</p> <p>e. An SF6 breaker shall be drained of gas before any work is performed directly above it.</p> <p>5. Diesel Maintenance</p> <p>a. Refer to Section 6.8 Lockout/Tagout for information on local lockout/tag-out procedures.</p>
<p>5.11.6 Definitions</p>	<p>Risk Assessment: a documented process by which employees identify risks and hazards and determine the barriers that must be put in place in order to accomplish their work safely.</p> <p>RTU: Remote Terminal Unit</p> <p>Tailboard Briefing: an informal safety meeting, which is generally conducted at the job site prior to the commencement of a job or work shift. Job supervisors can draw attention to hazards, processes, equipment, tools, environment and materials to inform all workers of the risks in their surroundings.</p>

Section 5	Transmission and Distribution	
5.12	Mobile Substations	Effective Date: 1/1/2016 Revised:
5.12.1 Purpose	The mobile substation is a unique piece of equipment that requires special consideration when transporting and installing. This section provides safe work practices for transporting and installing mobile substations.	
5.12.2 Responsibilities	<ol style="list-style-type: none"> 1. The Company is responsible for developing the mobile substation installation plan. 2. The truck tractor driver is responsible for making sure all loads are secure and meet all federal and state laws, rules and regulations. 3. Employees are responsible for making sure all procedures are followed when installing and energizing a mobile substation. 	
5.12.3 Requirements	<ol style="list-style-type: none"> 1. Mobile Substation 2. Truck Tractor 3. Associated Equipment for Hook-up 4. Dolly Wheel Blocks 5. Flaggers, if applicable 6. Permits, as required 7. Grounding Mats 8. Fence, if applicable 	
5.12.4 Risk Identification	<ol style="list-style-type: none"> 1. Equipment damage when transporting or positioning mobile substation. 2. Property damage or personal injury when moving mobile substation. 3. Energizing or de-energizing hazards from improper switching plan. 4. Overhead hazard due to low clearance to energized parts 	
5.12.5 Safe Work Practices	<ol style="list-style-type: none"> 1. Transportation <ol style="list-style-type: none"> a. The mobile substation shall be transported by a qualified driver. b. Do not transport the mobile substation until proper permitting has been obtained, if needed. c. Ensure the steering axle on mobile substations is in the locked and neutral position before transporting. d. Adequate spotters shall be used to provide guidance when positioning the mobile substation. e. When the substation is parked, and if applicable, the dolly wheels shall be rested on the special dolly wheel blocks provided with the mobile substation. 2. Energizing and De-Energizing <ol style="list-style-type: none"> a. An approved energization plan shall be developed and followed for each installation of the mobile substation. b. Conduct an onsite pre-use inspection of the mobile substation before energizing. 	

	<ul style="list-style-type: none"> c. Red tag protection and MAD zone clearance shall be obtained before making primary connections. Refer to Section 6.5 Red Tag and Section 5.4 Minimum Approach Distances for more information. d. The orders to energize and de-energize the mobile substation shall be completed in accordance with Section 6.2 Switching and Tagging Communication. <p>3. Fencing and Grounding</p> <ul style="list-style-type: none"> a. Grounding the mobile substation shall be done as follows: <ul style="list-style-type: none"> i. The mobile substation shall have two independent grounding connections to the existing substation ground grid. ii. Grounding connections shall be installed as close as practical to the power transformer neutral and/or the local neutral that is being sourced from the mobile substation. iii. On metal substation structures, grounding lugs may be used in place of direct attachment to the tower or box girder ground or the substation ground grid. b. Mobile substation locations shall require the use of switch mats used at operator or switchman locations. The mobile sub shall have suitable switch mats stored on board for use at installation sites. c. Approved temporary fencing, including grounding mats, shall be placed around the mobile substation when required. d. Temporary fences shall be adequately grounded. e. To protect employees from energized parts not meeting NESC clearance requirements one of the following shall be done: <ul style="list-style-type: none"> i. An approved four foot fence shall be installed around the energized parts. ii. The energized parts shall be elevated to meet NESC clearance requirements.
<p>5.12.6 Definitions</p>	<p>Energization Plan: a detailed plan for the physical and electrical installation of mobile substations. A plan should include: mobile installation description, engineering settings and phasing three-line diagram.</p> <p>Mobile Substation: a completely self-contained trailer mounted substation.</p> <p>NESC: National Electrical Safety Code</p> <p>Spotter: a person who is responsible to watch for and guide another person away from potential dangers.</p>

Section 5	Transmission and Distribution	
5.13	Wire Pullers /Tensioners	Effective Date: 1/1/2016 Revised:
5.13.1 Purpose	Wire pullers/tensioning equipment are regularly used in the construction of underground and overhead lines. Due to the potential for electrical contact and the tension created during use, this tool poses increased hazards. This section provides information and safe work practices for the use of wire pullers/tensioners.	
5.13.2 Responsibilities	<ol style="list-style-type: none"> 1. The Company shall provide the proper wire pullers/tensioning equipment. 2. The employee is responsible for proper set-up before use. 3. The employee shall ensure communication capabilities are available. 	
5.13.3 Requirements	<ol style="list-style-type: none"> 1. Two-way Radio 2. Protective Grounds 3. Rigging Hardware 4. PPE 	
5.13.4 Risk Identification	<ol style="list-style-type: none"> 1. Equipment or communication failure resulting in personal injury or property damage. 2. Serious injury or death due to electrical contact. 3. Traffic around the work zone. 4. Public safety around the work zone. 	
5.13.5 Safe Work Practices	<ol style="list-style-type: none"> 1. Reel handling equipment and wire pulling/tensioning equipment shall be inspected for defects before use, including: <ol style="list-style-type: none"> a. stringing and pulling lines b. conductor grips and swivels c. load bearing hardware 2. Prior to starting work, proper tagging clearance shall be obtained per Section 6 Switching and Tagging, if required. 3. Reliable communications, preferably by two-way radio, shall be maintained between the reel tender, pulling rig operator and persons assigned to watch road crossings. 4. Work area around the trailer must be barricaded prior to starting work if necessary for public safety. 5. When possible, wire pulling/tensioning equipment should be set back from the first pole a distance equal to three times the height of the pole and should be level and aligned. 6. When the recommended set back distance cannot be obtained due to work area constraints, pull from the second pole or shorten the length of the pull to lessen the strain. 7. Reel trailers and wire pulling/tensioning equipment shall be anchored by being chained to a pole or hooked to a truck. Trailer wheels shall be 	

	<p>chocked.</p> <p>8. Pull lines and conductors shall be fully installed in a pulling grip.</p> <p>9. Where there is a possibility of contact with an energized conductor or induced voltage, the pulling equipment and conductor being installed or removed shall be grounded or provisions made to protect the employee from the hazard.</p> <p>10. When crossing energized lines is unavoidable, or if contact with energized lines is likely, sufficient cover-up shall be used to insulate these lines from the conductor being pulled.</p> <p>11. Rubber gloves shall be worn by the operator and any other nearby worker when contact with energized primary lines is possible.</p> <p>12. While a new conductor or pulling line is in motion, workers are not permitted directly under the overhead operations or on the crossarm, except as necessary to guide lines over or through sheaves.</p> <p>13. Reels of wire left standing shall be blocked to prevent rolling.</p>
5.13.6 Definitions	Barricade: a physical obstruction such as tape, screens, or cones intended to warn and limit access to a hazardous area.

Section 5	Transmission and Distribution	
5.14	Communication Lines	Effective Date: 1/1/2016 Revised:
5.14.1 Purpose	In the course of their work, employees may come into contact with company or privately owned communication lines. Employees should be familiar with the hazards of these lines. This section provides safe work practices regarding communication lines.	
5.14.2 Responsibilities	<ol style="list-style-type: none"> 1. The Company is responsible for training employees regarding communication line hazards. 2. The employee is responsible for following safe work practices regarding communication lines. 	
5.14.3 Requirements	<ol style="list-style-type: none"> 1. PPE 2. Fiber Optic Equipment 3. Coordination with Contractor or Communications Company 	
5.14.4 Risk Identification	<ol style="list-style-type: none"> 1. Communication and electrical lines coming into contact resulting in serious injury. 2. Downed wires creating a public safety hazard. 3. Eye Injuries from exposure to laser radiation. 	
5.14.5 Safe Work Practices	<ol style="list-style-type: none"> 1. General <ol style="list-style-type: none"> a. Employees shall ensure that there is no contact between energized conductors and communication cables before beginning work. b. Communication cables and equipment on joint-use poles have the potential to become energized. c. Improperly installed communication loops or cables that are contacting energized conductors shall be reported to Central Dispatch or the supervisor. d. Communication cables and equipment shall be covered with appropriate protective devices, as necessary. e. Employees should only work on communication cables and equipment owned by another company when it is necessary for public safety. f. Employees should be aware that communication cables may be under high tension. 2. Fiber Optic Communication <ol style="list-style-type: none"> a. Only qualified employees shall work on fiber optic enclosures. b. Only unpowered optical fibers shall be examined with the naked eye. If uncertain if powered or not, do not look into an exposed fiber or connector. c. If a fiber optic cable is damaged, any exposed ends shall be 	

	<p>covered to prevent exposure to possible laser radiation by those working in the area.</p> <ul style="list-style-type: none"> d. Whenever possible, power shall be removed from optical fibers before work is commenced. e. When splicing OPGW cable, all cables shall be grounded to an approved ground. f. Fiber optics used in the control of aerial lift equipment use LED's and are not dangerous.
<p>5.14.6 Definitions</p>	<p>Joint Use Poles: poles that carry both power and communication cables and/or equipment.</p> <p>LASER (acronym for Light Amplification by Stimulated Emission of Radiation): an intense, highly directional light source of invisible infrared and ultraviolet light, which can cause eye damage.</p> <p>LED: Light Emitting Diode</p> <p>OPGW: Optical Ground Wire</p>

Section 6	Switching and Tagging	
6.1	Roles, Responsibilities and Qualifications	Effective Date: 07/30/2013 Revised: 2/28/2021
6.1.1 Purpose	The switching and tagging safe work practices are designed to protect employees and prevent property damage. This section provides information on the roles, responsibilities, and qualifications for those engaged in switching and tagging activities.	
6.1.2 Responsibilities	<ol style="list-style-type: none"> 1. The Company is responsible for providing appropriate training for employees performing switching and tagging operations. 2. The System Operations supervisor is responsible for maintaining the list of employees qualified to switch and tag. 3. Supervisors are responsible for ensuring that their employees understand and are following the switching and tagging safe work practices. 4. Employees are responsible for observing all switching and tagging safe work practices. 	
6.1.3 Requirements	<ol style="list-style-type: none"> 1. Completion of the switching and tagging training program. 2. Completion of the required progression steps. 	
6.1.4 Risk Identification	<ol style="list-style-type: none"> 1. Unqualified employees performing switching and tagging operations. 2. Personal injury or property damage due to incorrect switching and tagging. 	
6.1.5 Safe Work Practices	<ol style="list-style-type: none"> 1. Training and Qualifications <ol style="list-style-type: none"> a. To be qualified and eligible to perform switching and tagging, employees shall complete the following: <ol style="list-style-type: none"> i. switching and tagging training program ii. progression steps b. The switching and tagging training program documents shall be forwarded to the applicable department supervisor and Safety Department. 2. Switching and Tagging Lists <ol style="list-style-type: none"> a. The System Operations supervisor, with the approval of the appropriate department supervisor, shall publish and revise the list as necessary. b. Employees shall only perform switching and tagging tasks that are within their area of responsibility as identified on the switching and tagging list. c. Some employees may have limited authority. For additional information refer to Section 6.1 Attachment A. d. Operating Switching Instructions, clearance and/or protection shall be given only to employees whose names appear on the switching and tagging list. 	

	<ul style="list-style-type: none"> e. Only Operating Switching Instructions will be given to employees who are on the switching list. f. To remain on the switching and tagging list, employees shall switch and hold a tag for equipment that is under the control of the System Operations at least once in a 12-month period. <ul style="list-style-type: none"> i. Employees not meeting this requirement will be removed from the switching and tagging list until recertified. ii. Recertification will require successful completion of switching and tagging training program. g. Failure to comply with the rules may result in an employee being removed from the switching list or the switching and tagging list. <p>3. Dispatching Under System Operations Control</p> <ul style="list-style-type: none"> a. The following equipment is under System Operations control: <ul style="list-style-type: none"> i. All transmission equipment. ii. All substation equipment within the substation fence, operating over 600 volts, or directly involved in controlling T&D equipment. Exception: PT, AMR, & Station Service disconnects, will be switched and tagged under local control and reported to SO for awareness and logging purposes. iii. All SCADA controlled equipment. iv. All switches, disconnects, or electrical apparatus intended to tie two circuits or substations together. v. Distribution equipment servicing commercial generators larger than 750kW. vi. Industrial customers. vii. Other control areas, such as Central Maine Power. b. System Operations shall provide clear Operating Switching Instructions and keep an accurate record of all of work performed under their control. <p>4. Dispatching Under Local Control</p> <ul style="list-style-type: none"> a. All equipment not under System Operations control is under Local Control. b. A qualified employee shall provide local switching information to Central Dispatch during normal business hours or to System Operations for all other times. c. Central Dispatch or System Operations shall log, by recording, all local switching and tagging activities. d. Employees shall not operate any piece of equipment or apparatus under Local Control without direct Operating Switching Instruction from the Tag Holder.
<p>6.1.6 Definitions</p>	<p>Refer to Section 6.10</p>

~~Switching and Tagging—Limited Diesel Generator Switching~~

- ~~1. Limited Diesel Generator Switching:~~
 - ~~a. Limited switching and tagging shall be permitted on diesel generation systems by Power System Technical—Electrical-Mechanical Worker 1st Class employees.~~
 - ~~b. Limited diesel generator switching includes:~~
 - ~~i. Eastport~~
 - ~~ii. local lock out/tag out of transfer switches connecting permanently installed local propane generators to Versant Power facilities~~
- ~~2. In Scope:~~
 - ~~a. The following functions shall be permitted for employees listed on the limited diesel switching list:~~
 - ~~1. Local control of all diesel systems to include:~~
 - ~~a. Placing units in isolation~~
 - ~~b. Pulling the starting fuses~~
 - ~~2. Isolation of diesel breakers to include:~~
 - ~~a. “Racking” out of metal clad breakers to secure Red Tag protection or Blue Tag clearance.~~
 - ~~b. Placing unit breakers in test position for troubleshooting and testing purposes.~~
 - ~~3. Tagging of diesel unit breakers for Do Not Reclose or Yellow Tag functions~~
 - ~~a. Isolating the diesel units and placing a Yellow Tag on the unit breakers.~~
 - ~~b. Isolating the diesel unit controls and placing a Yellow Tag on the unit controls to prevent the starting or restarting of a diesel unit.~~
 - ~~c. All Yellow Tags shall be placed at the request of a person listed on the switching and tagging list (not the limited diesel switching and tagging List) as directed by the System Operator.~~
- ~~3. Not In Scope:~~
 - ~~a. The following functions shall not be permitted for employees listed on the limited diesel switching list:~~
 - ~~1. Switching and/or tagging on electrical or mechanical apparatus that is not directly associated with the operation and maintenance of diesel generation systems such as generator step up transformers & devices, station service transformers or breakers, potential transformers, current transformers etc., shall not be permitted.~~
 - ~~2. The placing or verifying of tags on non-diesel generation system breakers such as metal clad breakers, reclosers, line switches, and similar equipment shall not be permitted.~~

Section 6	Switching and Tagging	
6.2	Switching and Tagging Communication	Effective Date: 07/30/2013 Revised: 2/28/21
6.2.1 Purpose	Clear communication is essential to safe switching and tagging procedures. This section provides information and safe work practices regarding three-part communication <i>within the Versant Power System and on the Bulk Electric System.</i>	
6.2.2 Responsibilities	<ol style="list-style-type: none"> 1. The Company is responsible for ensuring that employees are trained in three-part communication. 2. <i>Employees are responsible to use three-part communication for all Operating Instructions, including Operating Instructions with Central Maine Power "CMP" and New Brunswick Power "NBP" as the Reliability Coordinator and Transmission Operator.</i> 3. Employees are responsible for following the safe work practices. 	
6.2.3 Requirements	<ol style="list-style-type: none"> 1. Communication System: <ol style="list-style-type: none"> a. company radio b. substation phone c. cellular or satellite phone d. <i>phone communication with CMP and NBP</i> 2. <i>Three-part communication and Operating Instructions must use the English language</i> 3. <i>Three-part communication must use the provided nomenclature for Elements and Facilities, including on all interfaces.</i> 	
6.2.4 Risk Identification	<ol style="list-style-type: none"> 1. Miscommunication resulting in incorrect switching and tagging action. 2. <i>Miscommunication that could lead to action or inaction harmful to the reliability of the Bulk Electric System (BES)</i> 	
6.2.5 Safe Work Practices	<ol style="list-style-type: none"> 1. The Company's radio system, if available, shall be used for switching and tagging communications. 2. Cellular phones or substation telephones may be used when performing switching on substation equipment. 3. <i>System Operations will use verbal phone communication when giving or receiving Operating Instruction between CMP and NBP Energy Control Center Operators.</i> 4. Each person performing switching and tagging communication shall state their full name for identification. 5. Three-part communications: switching and tagging <i>Operating Instructions orders</i> shall be given in the following order: <ol style="list-style-type: none"> a. The issuer clearly delivers the <i>Operating Instructions message</i>. b. The receiver repeats the <i>Operating Instructions message</i> or requests the <i>Operating Instructions message</i> to be re-issued. c. The issuer confirms the repeated <i>Operating Instructions message</i> 	

	<p>is correct, re-issues the <i>Operating Instructions message</i>, if requested, or takes an alternative action <i>if a response is not received or the Operating Instruction was not understood by the receiver</i>.</p> <ol style="list-style-type: none"> 6. If a third person is required to relay the <i>Operating Instructions message</i>, they shall follow the same procedure above. 7. The switcher shall perform all <i>Operating Instructions switching and tagging orders</i> exactly as directed. 8. If the switcher believes the <i>Operating Instructions switching and tagging orders</i> are incorrect, dangerous or they are not competent to complete the task, they shall stop the work and seek further instruction.
<p>6.2.6 Definitions</p>	<p>Refer to Section 6.10</p>

Section 6	Switching and Tagging	
6.3	General	Effective Date: 07/30/2013 Revised: 2/28/21
6.3.1 Purpose	The purpose of this section is to provide general information on switching and tagging safe work practices to ensure employee safety and prevent equipment damage when performing switching and tagging procedures.	
6.3.2 Responsibilities	<ol style="list-style-type: none"> 1. Employees are responsible for following the safe work practices. 2. <i>Employees are responsible to correctly identify and tag their complete zone of protection.</i> 	
6.3.3 Requirements	<ol style="list-style-type: none"> 1. Qualified switching and tagging employee 2. Proper tags for the intended work function 	
6.3.4 Risk Identification	<ol style="list-style-type: none"> 1. Improper tagging 2. Unqualified employees performing work 3. Serious injury or death caused by electrical contact 	
6.3.5 Safe Work Practices	<ol style="list-style-type: none"> 1. General <ol style="list-style-type: none"> a. The following is required to obtain work clearance or protection: <ol style="list-style-type: none"> i. verification that points of isolation and controlling devices are in the correct position ii. required tags are in place b. Protective or clearance tags shall be: <ol style="list-style-type: none"> i. the appropriate color for class of protection or clearance ii. properly completed with the following information: <ol style="list-style-type: none"> 1. apparatus or line being tagged 2. name of the person holding the tag 3. name of the person performing the switching 4. the date and time of tag placement and removal iii. In a protective zone, a red tag must be attached to all open devices that may energize the circuit or apparatus. If a new known source of potential is introduced into a red tag zone (e.g., bridging of overbuild/under build by tree or dropped conductor, mobile substation installation, etc.), crews working under that zone of protection shall stand down until the integrity of the zone is confirmed. iv. removed only with the permission of the tag holder or his designate as defined by section 6.5.5 2e v. used only for the purpose intended c. Tags shall be attached using an approved tie-wrap or padlock. d. When tags and locks cannot be attached directly to a switch or disconnect the tag shall be: <ol style="list-style-type: none"> i. attached to a shepherd's hook placed directly on the switch, or 	

- ii. attached to the affected utility pole or structure in a location that is highly visible
- e. Tag holders shall report clear of their tag at the end of the work day.
- f. If tags are left on overnight, clearance shall be re-established prior to starting work the next day.
- g. System Operations shall hold a tag for equipment that is out of service.

2. Switching of Equipment under System Operations Control

- a. Prior to switching, the person who is to perform the work shall obtain authorization from System Operations.

3. Switching of Equipment under Local Control

- a. Under local control the tag holder shall act as the System Operator and assume control of equipment within their zone of protection.
- b. Prior to operating locally controlled devices that are located in-line between a recloser and a tie switch/tie disconnect, the switch person shall contact the System Operator for permission to perform the switching. The switch person shall also contact the System Operator after switching is complete.
- c. Switching shall not be done until the tag holder has:
 - i. coordinated with the affected workers
 - ii. issued *Operating Instructions switching-orders*
 - iii. provided authorization to proceed
- d. After placing or removing tags, the employee-in-charge shall communicate the following to the appropriate dispatch center:
 - i. full name of employee-in-charge or tag holder
 - ii. equipment to be worked on
 - iii. time tag is placed
 - iv. all tagged equipment

4. Tagging Cut Taps

- a. If the points of isolation are taps, they shall be:
 - i. cut
 - ii. mechanically secured in the open position
 - iii. verified to be visually opened
 - iv. appropriately tagged

5. Transferring Tag Holders

- a. The new tag holder shall verify the clearance or protection.
- b. A qualified employee shall be permitted to verify the status and placement of tags as directed by the tag holder.
- c. If there is an interruption during the transfer of tag holders, all work shall stop until clearance or protection is re-established.

	<p>6. Contractors</p> <ul style="list-style-type: none"> a. System Operations <u>shall not</u> hold a tag for a contractor. b. A qualified employee <u>shall</u> hold all tags on company owned equipment and ensure that contractors understand their zone of protection. c. For MEPCO or other jointly owned facilities, Versant Power System Operations will hold the tag of the contracting company. The contracting company will follow their switching and tagging procedures. d. Contractors can place tags and perform switching duties while under the direct supervision of a qualified employee who is at the work site. <p>7. Points of isolation between company-owned and industrial-owned facilities:</p> <ul style="list-style-type: none"> a. Switches and other electrical apparatus that are the primary isolation points between the Company and an industrial customer may require a double lock and tags held by both companies. b. All situations requiring multiple padlocks shall be authorized by the Company’s System Operator. c. All locks and/or tags placed by the industrial customer shall be placed on a lockout tree. <ul style="list-style-type: none"> i. The lock and/or tag shall only be placed along with the Company’s lock and/or tag. ii. Industrial customers shall remove all locks and tags after work is complete. d. For switches that allow for operation by either entity during normal operation (not clearance or protection), a locking bar or similar device with a control padlock at each end is permitted.
<p>6.3.6 Definitions</p>	<p>Refer to Section 6.10</p>

Section 6	Switching and Tagging	
6.4	Work Application Process	Effective Date: 07/30/2013 Revised: 1/31/2020
6.4.1 Purpose	The purpose of this section is to outline the application process for applying for protection or clearance tags on equipment under the control of System Operations.	
6.4.2 Responsibilities	<ol style="list-style-type: none"> 1. The Company is responsible for developing and implementing a work application process for switching and tagging activities and equipment maintenance. 2. Employees are responsible for submitting work order applications in a timely manner. 3. Employees are responsible to work within the zone of clearance as specified in the work application request. 	
6.4.3 Requirements	<ol style="list-style-type: none"> 1. Online Work Request Application 2. System Diagram 	
6.4.4 Risk Identification	<ol style="list-style-type: none"> 1. Work being performed without proper clearance or authorization. 	
6.4.5 Safe Work Practices	<ol style="list-style-type: none"> 1. Application Process <ol style="list-style-type: none"> a. When work is scheduled to be performed on equipment under the control of System Operations a work request application shall be submitted to System Operations within a reasonable time to allow for the necessary arrangements to be made. <ol style="list-style-type: none"> i. Applications shall be submitted by either: <ol style="list-style-type: none"> 1. applicable manager or supervisor 2. qualified employee with their manager or supervisor's approval ii. The application shall include the following information: <ol style="list-style-type: none"> 1. full name and contact information of the employee-in-charge 2. requested date and time of the work 3. time required to do the work 4. location and nature of the work 5. detailed description of all apparatus that will be involved 6. time required to restore the apparatus in the event of an emergency 7. if the job is weather dependent iii. The Work Application Request form is available on the Grid at: http://grid.versantpower.com/forms/systemoperations/Pages/default.aspx iv. Exception: Work Applications are not required for Yellow Tags on equipment operating at less than 15kV b. If the work is delayed or cannot be finished in the allotted time, the 	

	<p>employee-in-charge shall notify System Operations as soon as possible.</p> <p>2. Southern Operating Region (SOR) Job Description and Lead-Time</p> <p>a. Refer to the SOR System Operations guide for job description and lead time.</p> <p>3. Northern Operation Region (NOR) Job Description and Lead-Time</p> <p>a. Breaker Maintenance</p> <p>i. Applications for breaker maintenance that does not require an outage to transmission line segments or curtailment of customer load or generation shall be scheduled with System Operations a minimum of <u>24 hours</u> in advance.</p> <p>ii. If breaker maintenance requires an outage to a transmission line segment, curtailment of customer load, or curtailment of generation, the mandatory <u>72 hour</u> notice and posting will be observed.</p> <p>iii. Switching orders for breaker maintenance will be issued and reviewed at least <u>1 hour</u> prior to the job.</p> <p>iv. A walkthrough and tailboard briefing will be completed by all crews involved prior to commencing switching.</p> <p>b. Transmission Line Maintenance</p> <p>i. Applications for transmission line maintenance will be scheduled with System Operations allowing for the mandatory <u>72 hour</u> notice and posting period.</p> <p>ii. Switching orders will be issued to the proper supervisor a minimum of <u>24 hours</u> before the job.</p> <p>iii. A review of clearances and a tailboard briefing will be completed with crews prior to the job.</p> <p>c. Transmission Subs with Multi-tiered Buss Work</p> <p>i. Applications for maintenance in transmission substations with multi-tiered bus work will be scheduled with System Operations a minimum of <u>72 hours</u> (up to <u>96 hours</u> at the System Operator’s discretion) prior to the job.</p> <p>ii. System Operations will issue draft switching orders a minimum of <u>48 hours</u> prior to the commencement of work for review by applicable department supervisors.</p> <p>iii. Upon confirmation of established clearances the switching orders will be modified (if necessary) and issued as final.</p> <p>iv. Prior to the commencement of work a combined tailboard briefing and review of clearances with all involved crews will be held.</p> <p>d. Exception – Emergency Operations</p> <p>i. A work order may not be required for switching in emergency situations when approved by System Operations.</p>
<p>6.4.6 Definitions</p>	<p>Refer to Section 6.10</p>

Section 6	Switching and Tagging	
6.5	Red Tag	Effective Date: 07/30/2013 Revised: 2/28/21
6.5.1 Purpose	Red Tags are intended to prevent the operation of electrical lines and equipment without authorization of the controlling authority.	
6.5.2 Responsibilities	<ol style="list-style-type: none"> 1. The tag holder is responsible for the safety of all the workers under their direction. 2. The tag holder is responsible for ensuring that proper procedures for isolating lines and equipment are used. 3. Employees are responsible to correctly identify and tag their complete zone of protection. 	
6.5.3 Requirements	<ol style="list-style-type: none"> 1. System Diagram 2. PPE 3. Tailboard Briefing 4. Switching Plan, as applicable 5. Red Tags 	
6.5.4 Risk Identification	<ol style="list-style-type: none"> 1. Improper tagging 2. Unqualified employees performing work 3. Serious injury or death caused by electrical contact 	
6.5.5 Safe Work Practices	<ol style="list-style-type: none"> 1. Red Tag Lifesaving Rule <ol style="list-style-type: none"> a. Employees shall not remove a Red Tag or operate a switch, disconnect or breaker which bears a red tag without proper authorization. 2. General <ol style="list-style-type: none"> a. Red tags shall be used to identify lines or equipment that are not to be operated or have their status changed. b. System Operations and/or the tag holder shall acknowledge and approve switching or sectionalizing within a red tagged area. c. Red tags shall only be removed with the permission of the tag holder. d. The order to remove a red tag shall not be given until all persons have 	

been reported clear.

- e. A red tag may be cleared through consultation between the department supervisor and System Operations if the original tag holder is not available.
- f. The decision of the department supervisor and System Operations shall be communicated to the workers at the work site.
- g. *To perform work on isolated, primary ungrounded lines, a red tag zone of protection needs to be established, with visual openings at the source and all ties to other circuits confirmed open, locked if possible and red tagged. The line should be tested for the absence of voltage before work commences. Energized work practices shall be followed.***

3. Red Tag Requests, Placement and Removal

- a. Work requiring lines or equipment to be taken or held out of service shall require red tag protection.
- b. If a new known source of potential is introduced into a red tag zone (e.g., bridging of overbuild/underbuild by tree or dropped conductor, mobile substation installation, etc.), crews working under that zone of protection shall stand down until the integrity of the zone is confirmed.
- c. Red tag protection shall be acquired from System Operations using the following process:
 - i. Person requiring protection (applicant) shall contact System Operations and state their protection request.
 - ii. System Operations shall acknowledge the request and provide ***Operating Instructions ~~switching orders~~*** to establish protection.
 - iii. The applicant shall carry out the ***Operating Instructions orders*** provided by System Operations.
 - iv. The applicant shall report the completion of the ***Operating Instructions orders*** to System Operations.
 - v. System Operations shall grant protection to the applicant.
 - vi. The applicant can then begin work.
- d. Local red tag protection shall be acquired using the following process:
 - i. The red tag holder shall establish their zone of protection.
 - ii. The red tag holder shall complete all necessary switching.
 - iii. Once completed the red tag holder shall report to Central Dispatch, ***or System Operations when Central Dispatch is closed***, the status of the lines or equipment under their control.
 - a. Central Dispatch does not provide the protection that is held by the tag holder.
- e. If more than one crew calls for red tag protection on the same lines or equipment:
 - i. Each crew shall establish their own protection.
 - ii. The line or equipment may not be energized until all red tags are cleared.
- f. When red tag protection work is completed under System Operations control the tag holder shall:
 - i. Ensure all crews are clear and protective grounds have been removed

	<ul style="list-style-type: none"> ii. Notify System Operations of their intention to remove the red tag or ask for authorization to remove the red tag iii. Release their protective tags iv. On three-phase main lines, verify that there is no red tag work being performed under local control downstream of the red tag being cleared. <ul style="list-style-type: none"> a. If there is work being performed on that three phase main line, request the tag holder to have crews be in the clear while re-energizing that upstream line section. Upon re-energization, the red tag holder may authorize workers to resume work under the same red tag. v. Report to System Operations all lines or equipment still out-of-service at the end of each day g. When red tag protection work is completed under System Operations control the System Operator shall <ul style="list-style-type: none"> i. On three-phase main lines, verify that there is no RT work being performed under S.O. control downstream of the red tag being cleared. ii. If there is work being performed on that three phase main line, request the tag holder to have crews be in the clear while re-energizing that upstream line section. Upon re-energization the crews the tag holder may authorize workers to resume work under the same red tag. h. When the local red tag protection work is completed the tag holder shall: <ul style="list-style-type: none"> i. Ensure all crews are clear and protective grounds have been removed ii. Release their protective tags iii. Verify step 6.5.5.3.f.iv is completed, as stated above iv. notify Central Dispatch of the status of their tags and the lines or equipment <p>4. Operation of URD Ground Switches with a common operator handle</p> <ul style="list-style-type: none"> a. The proper red tagged zone will be established through System Operations or Local Control. b. Once red tag protection has been issued and all personnel are clear, under the direction of the tag holder it is permissible to remove the red tag from an Open position and move the switch to the Ground position, lock in the Ground position and replace the red tag. c. Once work is completed, under the direction of the tag holder, it is permissible to remove the red tag from the Ground position, move the switch to the Open position, lock in the Open position and replace the red tag.
<p>6.5.6 Definitions</p>	<p>Refer to Section 6.10</p>

Section 6	Switching and Tagging	
6.6	Yellow Tag	Effective Date: 07/30/2013 Revised: 2/28/21
6.6.1 Purpose	Yellow Tags are to be used for work on or near energized circuits that do not require protection but do require clearance for the work being performed. <u>No</u> personal protection is given or inferred with the issuing of a yellow tag.	
6.6.2 Responsibilities	1. The tag holder is responsible for the safety of all the workers under their direction. 2. The tag holder is responsible for ensuring that proper procedures for tagging lines and equipment are used.	
6.6.3 Requirements	1. System Diagram 2. PPE 3. Tailboard Briefing 4. Switching Plan, as applicable 5. Yellow Tags	
6.6.4 Risk Identification	1. Improper tagging 2. Unqualified employees performing work 3. Serious injury or death caused by electrical contact	
6.6.5 Safe Work Practices	1. General <ol style="list-style-type: none"> Yellow tags shall be used to ensure that energized lines or equipment will not be re-energized if a fault occurs. The tag holder shall be on the job site and readily available. If more than one crew calls for yellow tag clearance on the same lines or equipment: <ol style="list-style-type: none"> each crew shall establish their own clearance all crews shall release their yellow tags before the device is operated 2. Energized Line Maintenance <ol style="list-style-type: none"> The employee-in-charge shall obtain yellow tag clearance for all work that places workers, materials and/or equipment within the MAD zone. This includes: <ol style="list-style-type: none"> running wire, manipulating or moving phase conductors 	

- ii. setting a pole or structure through energized conductors at or above 19.9/34.5 kV
- iii. handling or moving a phase conductor with a hot-line tool while outside the MAD zone
- b. Yellow tag clearance is NOT required to set a pole or structure through energized conductors below 19.9/34.5 kV providing pole hard cover is used or energized conductors are properly covered.
- c. Yellow tag clearance shall be in place prior to starting work.
- d. Outages on equipment while bearing a yellow tag:
 - i. all outages on lines or equipment bearing a yellow tag shall be reported to System Operations or Central Dispatch before re-energizing
 - ii. if a switch bearing a yellow tag opens automatically, it shall not be closed until authorized by the tag holder
 - iii. ***in the event of an outage while a crew is performing work under a yellow tag (energized work), the crew must stand down. If work is to continue, the tag must be changed to red and a red tag zone of protection must be established. The absence of voltage should be verified if ING work continues under the red tag. Assuming other crew(s) are patrolling for the line outage cause, all crews must communicate their status. The line shall not be re-energized until all crews are properly informed and clear of the line. Once the circuit is re-energized and the yellow tag zone of clearance is re-established, yellow tag work may resume.***

3. Yellow Tag Requests, Placement and Removal

- a. For proper yellow tag clearance on a line or equipment, the immediate upstream breaker or recloser shall have the reclosing turned off (if applicable) and shall be yellow tagged.
- b. If a new known source of potential is introduced into a yellow tag zone (e.g., bridging of overbuild/underbuild by tree or dropped conductor, mobile substation installation, etc.), crews working under that zone of clearance shall stand down until the integrity of the zone is confirmed.
- c. Yellow tag clearance shall be acquired from System Operations using the following process:
 - i. person requiring clearance (applicant) shall contact System Operations and state their clearance request
 - ii. System Operations shall acknowledge the request and provide ***Operating Instructions orders*** to establish clearance
 - iii. the applicant shall carry out the ***Operating Instructions orders*** provided by System Operations
 - iv. the applicant shall report the completion of the ***Operating Instructions orders*** to System Operations
 - v. System Operations shall grant clearance to the applicant.
 - vi. The applicant can then begin work
- d. Local yellow tag clearance shall be acquired using the following process:
 - i. the tag holder shall establish their zone of clearance
 - ii. the tag holder shall complete all necessary tagging

	<ul style="list-style-type: none"> iii. once completed the tag holder shall report to Central Dispatch, <i>or System Operations when Central Dispatch is closed</i>, the status of the lines or equipment under their control iv. Central Dispatch does not provide the clearance that is held by the tag holder e. When yellow tag clearance is completed under System Operations control the tag holder shall: <ul style="list-style-type: none"> i. ensure all crew(s) are clear ii. notify System Operations of their intention to remove the yellow tag or ask for authorization to remove the yellow tag iii. release their tags f. When the local yellow tag clearance work is completed the tag holder shall: <ul style="list-style-type: none"> i. ensure all crews are clear ii. release their tags iii. notify Central Dispatch, <i>or System Operations when Central Dispatch is closed</i>, of the status of their tags and the lines or equipment iv. If yellow tag clearance continues for more than one day the tag holder shall report “clear” and remove yellow tags at the end of each day. g. Yellow tags may be transferred to another qualified employee if the original tag holder leaves the job site, as described in Safety Manual Section 6.3.5 5
<p>6.6.6 Definitions</p>	<p>Refer to Section 6.10</p>

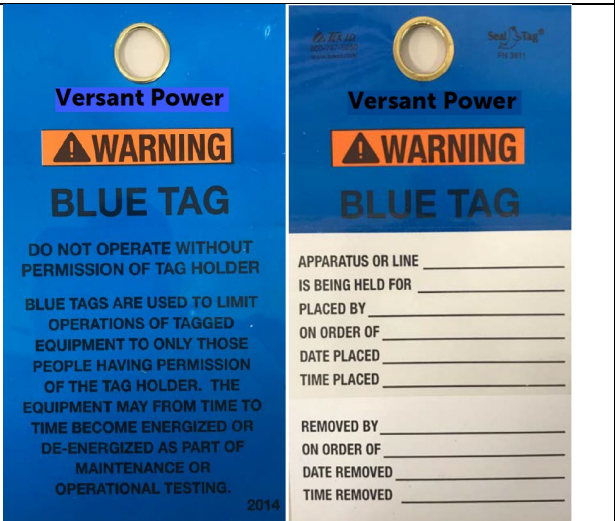
Section 6	Switching and Tagging	
6.7	Blue Tag	Effective Date: 07/30/2013 Revised: 2/28/2021
6.7.1 Purpose	Blue tags are used to provide the tag holder with clearance to operate or maintain equipment which may or may not be energized.	
6.7.2 Responsibilities	<ol style="list-style-type: none"> 1. The tag holder is responsible for the safety of all the workers under their direction. 2. The tag holder is responsible for ensuring that proper procedures for isolating lines and equipment are used. 	
6.7.3 Requirements	<ol style="list-style-type: none"> 1. System Diagram 2. PPE 3. Tailboard Briefing 4. Switching Plan, as applicable 5. Blue Tags 	
6.7.4 Risk Identification	<ol style="list-style-type: none"> 1. Improper tagging 2. Unqualified employees performing work 3. Serious injury or death caused by electrical contact 	
6.7.5 Safe Work Practices	<ol style="list-style-type: none"> 1. General: <ol style="list-style-type: none"> a. Blue tag clearance covers inspection, maintenance and other special operations which require frequent testing or switching. b. Apparatus bearing a blue tag may be energized, de-energized or operated only by order of the tag holder. c. If blue tag clearance continues for more than one day the tag holder shall report “clear” at the end of each day. <ol style="list-style-type: none"> i. When work has been completed and it is deemed the equipment must remain out of service the blue tag shall be changed to a white tag and held by System Operations. d. Under no circumstances shall a blue tag be used in conjunction with another tag. e. Only one blue tag shall be applied to an apparatus at a time. f. Within a red tag zone a blue tag is only required for devices with SCADA control and breakers/reclosers within a substation. g. It is permissible to exercise disconnects without a blue tag with Operating Instructions orders from a System Operator or under local 	

control with **Operating Instructions orders** from the tag holder

2. Blue Tag Requests, Placement and Removal

- a. Equipment bearing a blue tag shall be considered to be energized.
- b. Blue tag clearance shall be acquired from System Operations using the following process:
 - i. person requiring clearance (applicant) shall contact System Operations and state their clearance request
 - ii. System Operations shall acknowledge the request and provide orders to establish clearance
 - iii. the applicant shall carry out the **Operating Instructions orders issued provided** by System Operations
 - iv. the applicant shall report the completion of the **Operating Instructions orders** to System Operations
 - v. System Operations shall **issue grant** clearance to the applicant
 - vi. the applicant can then begin work
- c. Local blue tag clearance shall be acquired using the following process:
 - i. the tag holder shall establish their required clearance
 - ii. the tag holder shall complete all necessary tagging
 - iii. once completed the tag holder shall report to Central Dispatch, **or System Operations when Central Dispatch is closed**, the status of the lines or equipment under their control
 - iv. Central Dispatch does not provide the clearance that is held by the tag holder
- d. When blue tag clearance is completed under System Operations control the tag holder shall:
 - i. ensure all crew(s) are clear
 - ii. notify System Operations of their intention to remove the blue tag or for authorization to remove the blue tag
 - iii. the status of the equipment shall be communicated to System Operations (closed or open state)
 - iv. release their tags
 - v. if blue tag clearance continues for more than one day the tag holder shall report “clear” at the end of each day
- e. When the local blue tag clearance work is completed the tag holder shall:
 - i. ensure all crew(s) are clear
 - ii. release their tags
 - iii. notify Central Dispatch, **or System Operations when Central Dispatch is closed**, of the status of their tags and the lines or equipment
- f. Blue tags may be transferred to another qualified employee if the original tag holder leaves the job site, as described in Safety Manual Section 6.3.5 5
- g. The new tag holder shall know the operating status of the equipment before assuming the blue tag clearance.

**6.7.6
Definitions**

Refer to Section 6.10

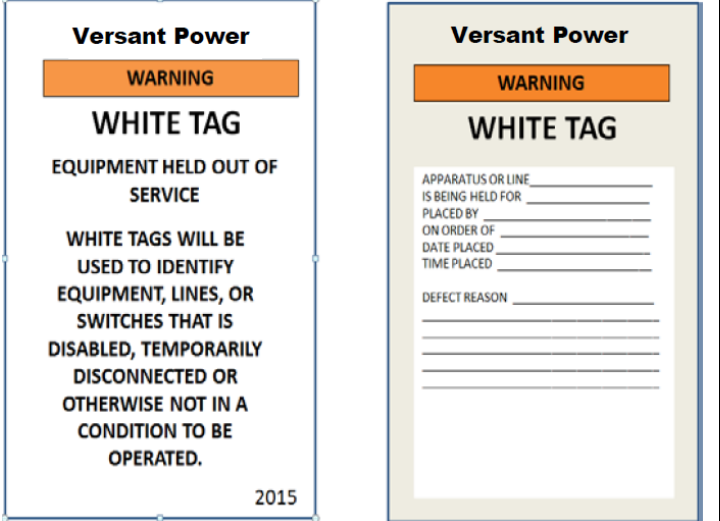
Section 6	Switching and Tagging	
	White Tag	Effective Date: 11/7/2016 Revised: 6/1/2020
6.8.1 Purpose	White Tags are intended to identify electrical lines and/or apparatus that are being held out of service or unavailable for service.	
6.8.2 Responsibilities	<ol style="list-style-type: none"> 1. The tag holder is responsible for the safety of all the workers under their direction. 2. The tag holder is responsible for ensuring that proper procedures for isolating lines and equipment are used. 	
6.8.3 Requirements	<ol style="list-style-type: none"> 1. System Diagram 2. PPE 3. Tailboard Briefing 4. Switching Plan, as applicable 5. White Tags 	
6.8.4 Risk Identification	<ol style="list-style-type: none"> 1. Improper tagging 2. Unqualified employees performing work 3. Serious injury or death caused by electrical contact 	
6.8.5 Safe Work Practices	<ol style="list-style-type: none"> 1. General <ol style="list-style-type: none"> a. White Tags indicate “Warning” and shall be used to identify equipment that is disabled, temporarily disconnected or otherwise not in a condition to be operated. Exception: For ongoing red tag work where red tags are left in place, white tags will not be required. b. White tags shall <u>not</u> be used for personal protection. c. White tags shall indicate the reason the equipment is being held out of service or is unavailable. d. White tags shall be removed only when the equipment or apparatus is determined ready for service. e. The white tag shall be placed in the name of the person responsible (ie: Division Supervisor) for locally controlled equipment or will be placed in the name of the System Operator for System Operator controlled equipment. f. New equipment may be white tagged before it is formally turned over for operation. 	

	<p>g. White tags shall be released, removed or transferred from one person to another as described in Section 6.3 General.</p> <p>h. Each respective area (System Operations or Central Dispatch) shall maintain and publish a database of white Tags.</p> <p>2. White Tag Requests, Placement and Removal</p> <p>a. In the case of single apparatus, a white tag shall be placed on the equipment, pole or apparatus being held out of service.</p> <p>b. In the case of a system, white tags shall be placed at all sources of potential or locations that may energize the system.</p> <p>c. For Versant Power lines being held out of service:</p> <ul style="list-style-type: none"> i. Placement: <ul style="list-style-type: none"> 1. Isolate with open <i>cutout or open tap</i>. It is not necessary to pick the top tap of cutout. 2. Place white tag. <i>No grounds are needed</i>. 3. Make line safe by cutting free any downed conductor(s) ii. Removal: <ul style="list-style-type: none"> 1. Remove White tag 2. Restore line <p>d. For private lines being held out of service:</p> <ul style="list-style-type: none"> i. Placement: <ul style="list-style-type: none"> 1. Isolate with open disconnect or cutout 2. Remove the top tap of disconnect or cut out. Air break switches that are being white tagged will not need taps removed, also if removing the top tap creates a hazard it is permissible to remove the bottom tap of the cutout. 3. Place White tag 4. Test for no voltage 5. Place Ground ii. Removal: <ul style="list-style-type: none"> 1. Remove Ground 2. Remove White tag 3. Reconnect top tap of disconnect or cut out 4. Restore line <p>e. Exceptions for seasonal disconnects: Overhead banks can have cutouts pulled and white tags installed. Crew shall verify that no voltage is present on the secondary side. Pad mount transformers that are locked with an Versant Power pad lock can have cutouts pulled and white tag installed. Crew shall verify that no voltage is present on the secondary side.</p>
6.8.6 Definitions	Refer to Section 6.10

Section 6	Switching and Tagging	
6.9	Lockout/Tagout: Electricity under 600 volts and Other Forms of Energy	Effective Date: 07/30/2013 Revised: 1/1/2017
6.9.1 Purpose	The purpose of this section is to provide employees with information regarding isolation of low voltage electricity (under 600 volts), pneumatic, hydraulic and mechanical energy.	
6.9.2 Responsibilities	<ol style="list-style-type: none"> 1. The tag holder is responsible for the safety of all the workers under their direction. 2. The tag holder is responsible for ensuring that proper procedures for isolating lines and equipment are used. 	
6.9.3 Requirements	<ol style="list-style-type: none"> 1. Serialized padlock and key issued to qualified employee 2. <600 volt lockout tag 3. Tailboard Briefing 4. Lockout/tagout Tags 	
6.9.4 Risk Identification	<ol style="list-style-type: none"> 1. Improper tagging 2. Unqualified employees performing work 3. Serious injury or death caused by electrical contact 	
6.9.5 Safe Work Practices	<ol style="list-style-type: none"> 1. Energy Isolation Before performing work on any system or piece of equipment, employees shall ensure that it is isolated from energy that could cause an accident or injury. <ol style="list-style-type: none"> a. Examples of energy include electrical, water, mechanical, chemical, heat, gravity etc. b. Proper department procedures for isolation of energy (lockout/tagout) shall be followed. c. Employees shall consult with their supervisor to obtain specific procedures for specific jobs. 2. Local Tagging Whenever a crew or other group of individuals performs servicing or maintenance on equipment not under the control of System Operations. <ol style="list-style-type: none"> a. General: 	

- i. The employee performing the lockout/tagout procedure is responsible to ensure machinery and equipment will not be damaged as a result of the lockout/tagout procedures.
- b. Employee-in-charge:
 - i. shall control the lockout or tagout device
 - ii. shall ensure all workers in the work zone are protected
 - iii. their padlock and tag shall be the first one placed and the last one removed
- c. Workers:
 - i. Each employee physically working on equipment that is tagged out of service shall place their personal padlock and tag to the group of padlocks and tags before beginning work.
 - 1. the padlock and tag shall be removed when the employee is finished working on the machine or equipment
 - 2. employee's name shall be clearly printed on their individual lockout tag

3. Lockout/Tagout

- a. Lockout devices and tags indicating "Do Not Operate" shall be placed on the appropriate valve, switch, fuse or similar device closest to the worksite.
- b. All switches, breakers and fused disconnects shall be locked out first and then tagged.
- c. A padlock shall be used if such provisions are available.
- d. If more than one employee or crew is to work on a locked or tagged device, then each employee shall place their own padlock and/or tag.
 - i. This shall be accomplished using a lockout tree that requires all padlocks be removed before the device can be operated.

4. Personal Lockout/Tagout Devices

- a. Each employee performing lockout/tagout shall be issued their own padlock, lockout device and tag.
 - i. Each padlock shall have two keys; one for the employee, the other under the control of the employee's supervisor.
 - ii. Each padlock shall contain a unique ID number that is recorded by the supervisor.
 - iii. At no time shall an employee share their padlock and/or padlock key with another employee.
 - iv. Each employee's tag shall contain:
 - 1. the employee's name
 - 2. date placed
 - 3. purpose for the tag

	<p>5. Equipment not designed to accept a padlock</p> <ul style="list-style-type: none"> a. Any device that cannot physically be locked with a padlock or locking device shall be properly tagged prior to starting work. b. Employee shall communicate these lockout instructions for future work on this device to their supervisor and Safety Department. <p>6. Safety Devices</p> <ul style="list-style-type: none"> a. When a safety device is to be locked or tagged it shall be done in a manner that does not create a more hazardous condition. <p>7. Manned Facilities and Substations</p> <ul style="list-style-type: none"> a. In a manned facility or substation, the owner or operator shall be notified prior to placing padlocks and/or tags. b. When complete, the owner or operator shall be notified <u>before</u> returning the locked or tagged device to its normal condition.
<p>6.9.6 Definitions</p>	<p>Refer to Section 6.10</p>

Section 6	Switching and Tagging	
6.10	Definitions	Effective Date: 07/30/2013 Revised: 2/28/21
6.10.1 Purpose	The definitions in this section are intended to provide clarity for items that are contained within Section 6.	
6.10.2 Responsibilities	<i>Employees will use definitions when reviewing Safety Manual Sections to insure clarity in understanding.</i>	
6.10.3 Requirements	<i>Operating Instruction definition is a NERC COM -002 requirement</i>	
6.10.4 Risk Identification		
6.10.5 Safe Work Practices		
6.10.6 Definitions	<p>Apparatus: all equipment pertaining to the generation, transmission, distribution and use of electric power.</p> <p>Apparatus Covered: all apparatus which is covered by a tag of a distinctive color.</p> <p>Apparatus Isolated: all apparatus which is disconnected from sources of dynamic power by means of a recognized isolating device.</p> <p>Applicant: a qualified person who is applying for a tag, or tags, to obtain protection or clearance on electrical equipment or apparatus. The term embraces all types of tags.</p> <p><i>Bulk Electric System (BES): All Transmission Elements operated at 100 kV or higher and Real Power and Reactive Power resources connected at 100 kV or higher. This does not include facilities used in the local distribution of electric energy. This is an abbreviated version of the NERC definition which has much greater detail.</i></p> <p>Charged: isolated but not de energized, containing stored energy.</p> <ol style="list-style-type: none"> 1. Electrical: A potential difference from earth or ground (i.e. charged with induced energy due to the close proximity to other energized apparatus). 2. Pneumatic & Hydraulic: Under a liquid or gaseous pressure different from that of the atmosphere. 3. Mechanical & Potential: Energy associated with the motion or position of an object & Energy which is stored (e.g. springs, compressors, linkages and etc.). <p>Clearance: permission to perform specified work or permission to enter a restricted area.</p>	

De Energized:

1. Electrical: Isolated from the electrical source
2. Pneumatic & Hydraulic: Isolated and not under pressure different from that of atmosphere.
3. Mechanical & Potential: Isolated and at rest, not retaining a charge.

Element: Any electrical device with terminals that may be connected to other electrical devices such as a generator, transformer, circuit breaker, bus section, or transmission line. An Element may be comprised of one or more components. NERC definition

Energized:

1. Electrical: Connected to a source of potential, or electrically charged so as to have a potential different from that of earth ground.
2. Pneumatic & Hydraulic: Under pressure different from that of atmosphere.
3. Mechanical & Potential: Not at rest, retaining a charge.

Facility: A set of electrical equipment that operates as a single Bulk Electric System Element (e.g., a line, a generator, a shunt compensator, transformer, etc. NERC definition

Industrial Customer: a large commercial customer who typically generates power or manufactures materials and has a qualified person or persons who operate and/or control their electrical distribution system. This customer typically has one or more substations and associated electrical apparatus. (e.g. Pulp and paper mill, large commercial generator and etc.).

Isolated: physically disconnected or separated from source of dynamic energy by means of approved isolating devices.

Isolating Devices: switches, or disconnecting apparatus, with visible contacts, the position of which can be positively determined to be both visibly and mechanically open by an inspection of the contacts or disconnecting means. These switches must also be equipped with effective blocking device to prevent the inadvertent operation of the device.

Isolated Not Grounded (ING): This refers to primary electrical conductors that have been disconnected from energy source(s) via open switch, breaker, disconnect, etc. but NOT grounded. ING Safe Work Practices are detailed in SWP 5.22. Key to SWP 5.22 is understanding that any primary ungrounded conductor must be considered energized and all energized work rules apply. Additionally, any work done on ING primary conductors requires a red tag zone of protection be established.

Lockout Tree: a lockout device that allows for multiple locks to be attached to the device to be isolated.

Mechanically Secured: a device designed to provide a positive block and mechanically prevent the operation of the device.

MEPCO: Maine Electrical Power Company

Minimum Approach Distance (MAD): the closest distance a qualified employee is permitted to approach either an energized or an un-grounded object, as applicable for the work method being used.

Multiple Locks: each authorized employee shall affix a personal lockout or tagout device to the group lockout device, group lockbox, or comparable mechanism when he or she begins work, and shall remove those devices when he or she stops working on the machine or equipment being serviced or maintained.

Multi-Tiered Bus Work: a substation configuration that consists of at least a main bus and a transfer bus configured in such a way that the main bus is on the bottom with the transfer bus installed directly above it.

NERC: North American Electric Reliability Corporation – formed by the electric utility industry to promote the reliability and adequacy of bulk power transmission in the electric utility systems of North America. NERC's mission states that it is to "ensure the reliability of the North American bulk power system." NERC's major responsibilities include working with all stakeholders to develop standards for power system operation, monitoring and enforcing compliance with those standards, assessing resource adequacy, and providing educational and training resources as part of an accreditation program to ensure power system operators remain qualified and proficient. NERC also investigates and analyzes the causes of significant power system disturbances in order to help prevent future events.

Operating Instruction: A command issued by a System Operator, or in the case of Locally Controlled equipment, the tag holder, as the controlling authority responsible for the safe, efficient, and reliable operation of equipment under their authority. A discussion of general information and of potential options or alternatives to resolve Bulk Electric System operating concerns is not a command and is not considered an Operating Instruction.

Operator: the person in charge of, and responsible for, the operation of apparatus, who is qualified and authorized to deal with matters under consideration

Proper Authorization (with respect to switching and tagging): is permission granted to employees, listed on the Switching & Tagging list maintained by SO, that follow the rules defined by Section 6.5.5 2a through 2f of this manual.

Protection: a system of locks and/or tags and applicable personal protective grounds that prevent someone or something from suffering harm or injury.

Qualified: a person who, by possession of a recognized degree, certificate, or professional standing, or who by extensive knowledge, training and experience, successfully demonstrates the ability to solve problems relating to the subject matter, the work or the project.

Reliability Coordinator: *The entity that is the highest level of authority who is responsible for the Reliable Operation of the Bulk Electric System, has the Wide Area view of the Bulk Electric System, and has the operating tools, processes and procedures, including the authority to prevent or mitigate emergency operating situations in both next-day analysis and real-time operations. NERC partial Definition, as applicable to this section.*

SCADA: Supervisory Control and Data Acquisition. An electronic remote control system designed to provide indication for and control of electrical and mechanical apparatus.

Specified Classes of Apparatus: electrical and mechanical devices that are electrically or mechanically attached to a specific, isolated, or clearly defined function (i.e. breakers and apparatus directly associated with diesel generators).

Switching List: the switching list includes the names of personnel who are authorized to perform switching operations and who may place a tag for a person on the Switching and Tagging List. A person on the Switching List may not hold a tag in their name.

Switching and Tagging List: the switching and tagging list includes the names of personnel who are authorized to be in charge of work or to assume responsibility for work on or near electrical apparatus under the tagging rules.

System Diagram: a one line diagram showing the configuration of the electrical system.

Tag Holder: a qualified person who is listed on the Switching and Tagging List who is authorized to hold a protective or clearance tag in his/her name for the purpose of safely completing work tasks.

Transmission Operator: *The entity responsible for the reliability of its "local" transmission system, and that operates or directs the operations of the transmission facilities. NERC definition. Local in this case is from a NERC perspective, not a Local Control vs. System Operator Control perspective.*

Zone of Clearance or Protection: an established work zone obtained within the switching and tagging process to ensure the required Switching and Tagging controls are in place prior to working on electrical equipment, lines, or apparatus. Zones of clearance require Yellow Tags **or Blue Tags** and Zones of protection require the use of Red tags, as applicable to the tag classification.

Section 7	Personal and Environmental Protection	
7.1	Hazard Communication Program (“HAZCOM”)	Effective Date: 1/1/2016 Revised:
7.1.1 Purpose	The purpose of this program is to ensure that the hazards of all chemicals used by Versant Power are evaluated and that information concerning their hazards is provided to affected employees.	
7.1.2 Responsibilities	<ol style="list-style-type: none"> 1. The Company is responsible for developing a written program that addresses the use of hazardous chemicals. (Title 29 CFR 1910.1200). 2. The Company is responsible for training employees on the written program. 3. Employees are responsible for understanding the hazards of the chemicals they work with. 	
7.1.3 Requirements	<ol style="list-style-type: none"> 1. Safety Data Sheets 2. PPE 	
7.1.4 Risk Identification	<ol style="list-style-type: none"> 1. Health or physical hazards due to chemical exposure. 2. Not being familiar with a chemical or product resulting in improper use. 	
7.1.5 Safe Work Practices	<ol style="list-style-type: none"> 1. Purchasing and Evaluation <ol style="list-style-type: none"> a. Purchasing or ordering any new chemical, solvent, compressed gas or other potentially hazardous material shall be in done in accordance with the following process: <ol style="list-style-type: none"> i. Complete the Chemical or Product Approval/Information Request Form. http://grid.versantpower.com/forms/environment/Pages/default.aspx ii. Forward the request form along with the SDS to the Safety Department. iii. The Safety Department shall conduct an initial product review to determine if the chemical or product should be used at the Company and included in the HAZCOM Program. iv. The Environmental Department shall conduct a subsequent review to determine any influence the product could have on the Hazardous Waste Disposal activities of the Company v. Product shall not be purchased until approved by both the Safety and Environmental Departments. vi. Accepting and use of promotional product samples is strictly prohibited unless approved. 2. Safety Data Sheet (SDS) <ol style="list-style-type: none"> a. The SDS shall be provided by the distributor at the time of the first shipment and with subsequent shipments after an update. b. The SDS can be requested from the manufacturer or distributor at any time. c. The supervisor is responsible to ensure the SDS is approved and available 	

- before any new chemicals/products are used.
- d. A copy of any updated SDSs shall be forwarded to the Environmental Department.
 - e. The SDS for products that are included under the HAZCOM Program shall be maintained in a Hazardous Chemical Inventory List in the SDS Electronic Database and shall be accessible to all employees.
 - f. A paper or CD copy of the SDS Electronic Database shall be located in every manned facility.
 - g. SDSs for hazardous chemicals no longer used at Versant Power shall be kept on file for thirty years.

3. Labeling

- a. Hazardous chemical or product containers shall be properly labeled by the manufacturer or distributor.
- b. Manufacturer's labels shall not be removed or altered.
- c. Shipping and receiving personnel shall ensure all hazardous chemicals received and shipped are properly labeled.
- d. When transferring a hazardous chemical from the manufacturer's container into a new container, the new container shall be marked with the following:
 - i. The name and address of the manufacturer.
 - ii. A legible hazard label, permanently displayed and written in English.
 - iii. Identity of the chemical.
 - iv. Appropriate hazard warnings, permanently displayed in English.
 - v. Hazard warning providing users with an immediate understanding of the primary health and/or physical hazard(s) through the use of words, pictures, symbols, or any combination of these elements.
- e. Portable containers shall comply with the labeling requirements listed above if any of the following events occur:
 - i. The material is not used within the work shift of the individual who makes the transfer.
 - ii. The worker who made the transfer leaves the work area
 - iii. The container is moved to another work area and is no longer in the possession of the worker who filled the container.
- f. The employee-in-charge shall ensure that all hazardous chemicals in their area are properly labeled at all times.

4. Information and Training

- a. Versant Power shall provide the following information to applicable employees:
 - i. Hazardous Communication Program.
 - ii. Location and availability of the HAZCOM written program.
 - iii. Safety Data Sheets and Hazardous Chemicals Inventory List.
 - iv. Operations in the work place where hazardous chemicals are present.
- b. HAZCOM training will be provided:

- i. Upon initial assignment of a job requiring exposure to hazardous materials.
- ii. Periodically as a refresher of initial training.
- iii. Whenever a new physical or health hazard that employees have not previously received training on is introduced into their work area.
- c. Training requirements shall include:
 - i. Methods and observations that may be used to detect the presence or release of a hazardous chemical or product in the work area.
 - ii. Physical and health hazards of chemicals in the work area.
 - iii. Protective measures implemented for routine and non-routine tasks, emergency procedures and personal protective measures.
 - iv. An explanation of labeling systems, SDSs and how employees can access information regarding hazardous chemicals.

5. Non-Routine Tasks

- a. Employees are periodically required to perform non-routine tasks that involve chemical hazards. Prior to starting such work, each affected employee will be provided information by the appropriate supervisor about the new hazardous chemicals to which they may be exposed. This information and training shall include:
 - i. The identities of chemicals and their specific health and safety hazards.
 - ii. Protective or safety measures the employee should take when using these chemicals.
 - iii. Measures Versant Power has taken to lessen the hazards of dealing with these chemicals including ventilation, respirators, presence of another employee, and emergency procedures.
- b. When an employee intends to use a chemical or product they are unfamiliar with, they shall review the SDS and address all questions or concerns with the supervisor prior to beginning work.

6. Contractors

- a. Upon request, Versant Power shall provide hazardous information to a contractor.
- b. The contractor is responsible for providing hazard communication and training of all its employees.
- c. The contractor is responsible for following the approval process above for any chemical or product which the contractor introduces into the Versant Power workplace.
- d. Contractor responsibilities pursuant to hazardous communication will be stipulated in the written contractual agreement where applicable.
- e. If additional training of Versant Power employees is necessary due to the introduction of a new chemical product by a contractor, appropriate hazardous communication training will be coordinated by the Safety Department Manager.

**7.1.6
Definitions**

Hazardous Chemical Inventory List: OSHA requires employers to maintain a list of the hazardous chemicals known to be present. The Hazardous Chemical Inventory lists the chemicals in use at that location. Any new hazardous chemicals received are to be documented in the Hazardous Chemical Inventory before use by any employee.

Safety Data Sheet (SDS): A formal document containing important information about the characteristics and actual or potential hazards of a substance.

Section 7	Personal and Environmental Protection	
7.2	Polychlorinated Biphenyls (PCBs)	Effective Date: 1/1/2016 Revised:
7.2.1 Purpose	The purpose of the section is to establish PCB awareness and to help prevent accidental exposure when handling PCBs.	
7.2.2 Responsibilities	<ol style="list-style-type: none"> 1. The Company is responsible for the oversight of proper handling, storage, clean-up and disposal of PCBs. 2. The Company is responsible for providing PCB awareness so that employees understand the hazards and risks of exposure. 3. The employee is responsible for complying with the Company's safe work practices. 	
7.2.3 Requirements	<ol style="list-style-type: none"> 1. PPE 2. Oil and Hazardous Material Spill Reporting and Cleanup Procedures 3. PCB Management Plan for the Applicable Facility 	
7.2.4 Risk Identification	<ol style="list-style-type: none"> 1. PCB exposure resulting in potential health hazards. 2. Environmental hazards created by PCB spills. 3. Company liability if PCBs are not managed according to Federal and State regulations. 	
7.2.5 Safe Work Practices	<ol style="list-style-type: none"> 1. Employees shall wear proper PPE when handling known or assumed PCBs. 2. Areas of the skin that have been in contact with suspected PCB containing fluids, or other dielectric fluids shall be washed as soon as possible with soap and water. Waterless hand cleaners should be avoided. 3. Heat decomposes PCBs, therefore breathing the vapors or fumes from heated or burning PCBs shall be avoided. 4. Should PCB's or other dielectric fluids be ingested, consult a physician as soon as possible. 5. When removed from service, equipment testing positive for PCBs shall be placed in a non-leaking container and taken to one of the following locations: <ol style="list-style-type: none"> a. Graham Station Facility b. Presque Isle Operations Center c. Division offices, if coordinated with the Environmental Department 6. Large, heavy equipment such as power transformers may be removed on-site by a certified hazardous waste contractor. 7. All capacitors shall be considered a PCB Article unless otherwise marked. 8. Any oil filled electrical equipment that <u>has not</u> been tested for PCBs shall be considered to be PCB contaminated until the equipment has been tested and found to be Non-PCB. 9. Spills of oil containing PCBs shall be handled in accordance with the Company's Oil and Hazardous Material Spill Reporting and Cleanup Procedure. http://grid.versantpower.com/pp/ep/Pages/default.aspx 	

7.2.6 Definitions	<p>Dielectric: insulating material or a very poor conductor of electric current.</p> <p>Non-PCB: any oil filled electrical equipment such as transformers, reclosers, regulators or oil that has been tested for PCBs and contains less than 50 ppm.</p> <p>PCB: polychlorinated Biphenyls are any of a family of industrial compounds produced by chlorination of biphenyl, used as insulating materials in electrical equipment, including transformers and capacitors, and in various other industrial applications.</p> <p>PCB Article or Oil: any oil filled electrical equipment such as transformers, reclosers, capacitors, regulators or oil that has been tested for PCBs and contains greater than 500 ppm.</p> <p>PCB Contaminated Article or Oil: any oil filled electrical equipment such as transformers, reclosers, regulators or oil that has been tested for PCBs and contains between 50 and 500 ppm.</p> <p>PPM: parts per million</p>
------------------------------	--

Section 7	Personal and Environmental Protection	
7.3	Asbestos	Effective Date: 1/1/2016 Revised:
7.3.1 Purpose	The purpose of the section is to establish asbestos awareness and to help prevent accidental exposure to asbestos containing materials (“ACM”)	
7.3.2 Responsibilities	<ol style="list-style-type: none"> 1. The Company is responsible for the oversight of asbestos abatement activities. 2. The Company is responsible for providing asbestos awareness training to affected employees so they understand the hazards and risks. 3. The Company shall ensure that no employee is exposed above the Permissible Exposure Limit. 4. The employee is responsible for complying with the Company’s safe work practices. 	
7.3.3 Requirements	<ol style="list-style-type: none"> 1. Licensed Asbestos Abatement Contractor 2. Facilities Maintenance Request Form for buildings 	
7.3.4 Risk Identification	<ol style="list-style-type: none"> 1. Asbestos exposure resulting in potential health hazards. 	
7.3.5 Safe Work Practices	<ol style="list-style-type: none"> 1. General <ol style="list-style-type: none"> a. Known asbestos areas shall be labeled if possible or the area shall be posted. b. Affected employees shall receive asbestos training annually. c. Materials known or suspected to contain asbestos: <ol style="list-style-type: none"> i. Structures built before 1980 are more likely to contain ACM ii. Thermal system insulation (formed or spray-on) iii. Vinyl floor tile iv. Ceiling tile v. Siding and shingles vi. Transite, including cement piping vii. Flame retardant materials such as gloves or curtains viii. Roof flashing d. Damaged ACM in buildings shall be reported to a supervisor and a Facilities Maintenance Request Form shall be completed. http://grid.versantpower.com/forms/facilities/Pages/default.aspx e. Damaged ACM in locations other than buildings shall be reported to a supervisor and the Environmental Department. f. Avoid touching or disturbing asbestos materials such as on walls, ceilings, pipes, ducts, floors or boilers. g. All facilities where there is known asbestos shall be inspected by a qualified third-party on an annual basis and repairs made as 	

	<p>necessary.</p> <ul style="list-style-type: none"> h. Asbestos abatement activities such as removal, clean-up, or repair shall only be performed by a Licensed Asbestos Abatement Contractor. i. Contractors who may be affected while working for the Company shall be notified. <p>2. Working Around Asbestos</p> <ul style="list-style-type: none"> a. Employees should know where asbestos is located in their work area. b. Prior to working in a location with known ACM, employees shall make an inspection to ensure the ACM is intact and has not crumbled, been pulverized or otherwise deteriorated. c. If ACM is intact, employees may perform work ensuring the ACM is not disturbed. d. Employees shall not drill, sand, saw or use nails on ACM, which would result in asbestos fibers being released into the atmosphere. e. If an employee suspects the existence of unmarked asbestos, the supervisor shall be notified prior to starting work in the area. <ul style="list-style-type: none"> i. Work shall not begin until the work area been has inspected and approved.
<p>7.3.6 Definitions</p>	<p>ACM: asbestos containing materials means any material containing more than one percent asbestos.</p> <p>Asbestos: includes chrysotile, amosite, crocidolite, tremolite asbestos, anthophyllite asbestos, actinolite asbestos, and any of these minerals that has been chemically treated and/or altered.</p> <p>Permissible Exposure Limit (PEL) for asbestos is 0.1 fiber per cubic centimeter of air as an eight-hour time-weighted average (TWA), with an excursion limit (EL) of 1.0 asbestos fibers per cubic centimeter over a 30-minute period.</p>

Section 7	Personal and Environmental Protection	
7.4	Acid	Effective Date: 1/1/2016 Revised:
7.4.1 Purpose	Acid can cause very serious damage upon contact with the body, therefore this section provides information and safe work practices for handling, storing and use of acid.	
7.4.2 Responsibilities	<ol style="list-style-type: none"> 1. The Company is responsible for providing appropriate training and equipment for handling acid. 2. Employees are responsible for following the safe work practices. 	
7.4.3 Requirements	<ol style="list-style-type: none"> 1. PPE 2. Safety Data Sheet (“SDS”) 3. Oil and Hazardous Material Spill Reporting and Cleanup Procedures 	
7.4.4 Risk Identification	<ol style="list-style-type: none"> 1. Inhalation, ingestion and contact with acid causing serious personal injury. 2. Fire or explosion hazard due to acids generating gases. 	
7.4.5 Safe Work Practices	<ol style="list-style-type: none"> 1. Prior to handling acids employees shall review the SDS for information on the hazards, toxic qualities, PPE and clean-up procedures. 2. Safety goggles, face shield, chemical rubber gloves and approved coverall suit shall be worn by employees handling acid. 3. Acid, in any quantity, shall be stored in an approved and properly labeled container. 4. Approved emergency eyewash stations shall be available where acids are handled. 5. Employees shall be familiar with the location of the eyewash station in the vicinity of the work, refer to Section 2.13 Eyewash Stations for additional information. 6. Acid containers shall be securely covered except when acid is being transferred into or out of containers. 7. The acid container shall be carefully examined for leaks or defects prior to moving or lifting. 8. Acid containers shall not be used for any other purpose. 9. Acid shall be stored in a cool well-ventilated area. 10. Acid spills shall be handled in accordance with the Company’s Oil and Hazardous Material Spill Reporting and Cleanup Procedure. http://grid.versantpower.com/pp/ep/Pages/default.aspx 11. Acids shall only be used in adequately ventilated rooms. 12. Employees shall remove all ignition sources when working with or near acid. 13. When mixing acid with water, always add acid to water, <u>never</u> the reverse. This does not apply to battery maintenance. 14. For information on battery maintenance, refer to Section 5.11 	

	<p>Substations and Section 9.2 Battery Charging.</p> <p>15. For additional information, refer to Section 7.1 Hazard Communication Program.</p>
<p>7.4.6 Definitions</p>	<p>Acid: any chemical substance with a pH lower than 7.</p> <p>pH: the measurement of the acidity or alkalinity of a solution.</p> <p>PPE: Personal Protective Equipment.</p> <p>Safety Data Sheet (SDS): a formal document containing important information about the characteristics and actual or potential hazards of a substance.</p>

Section 7	Personal and Environmental Protection	
7.5	Lead Paint	Effective Date: 1/1/2016 Revised:
7.5.1 Purpose	The purpose of the section is to establish lead awareness and to help prevent accidental exposure to lead containing paint.	
7.5.2 Responsibilities	<ol style="list-style-type: none"> 1. The Company is responsible for the oversight of lead abatement activities. 2. The Company shall ensure that no worker is exposed above the permissible exposure limit during lead abatement activities. 3. The employee is responsible for complying with the Company's safe work practices. 	
7.5.3 Requirements	<ol style="list-style-type: none"> 1. Licensed Lead Abatement Contractor 2. Lead Test Kit 3. Facilities Maintenance Request Form 	
7.5.4 Risk Identification	<ol style="list-style-type: none"> 1. Lead exposure resulting in potential health hazards. 	
7.5.5 Safe Work Practices	<ol style="list-style-type: none"> 1. Only a Licensed Lead Abatement Contractor shall be permitted to scrape or otherwise remove lead-based paint from known contaminated surfaces. 2. Employees shall treat any paint in buildings built prior to 1978 as lead-based unless it has been tested or is known not to contain lead. 3. If an employee suspects the existence of lead at a work location, prior to beginning work the employee shall either: <ol style="list-style-type: none"> a. Verify if a hazardous level of lead is present using Company supplied test kit. If the test is positive, send paint chip to approved laboratory for confirmation. b. Complete a Facilities Maintenance Request Form http://grid.versantpower.com/forms/facilities/Pages/default.aspx c. Work shall not begin until the work area has been inspected and approved. 4. Prior to working in a location with known lead containing paint, employees shall inspect the work space for chipping, cracking, or otherwise deteriorated paint. 5. If paint is intact, employee may perform work ensuring that lead paint is not disturbed. 	
7.5.6 Definitions	<p>Lead: metallic lead, all inorganic lead compounds, and organic lead soaps.</p> <p>Permissible Exposure Limit: The concentrate of lead in air above which requires mitigation. The airborne concentration of lead of 30 micrograms per cubic meter of air (30 ug/m³) calculated as an eight-hour time-weighted average (TWA).</p>	

Section 8	Compressed Gasses and Welding	
8.1	Compressed Gas Cylinders	Effective Date: 1/1/2016 Revised: 1/1/2017
8.1.1 Purpose	Compressed gas cylinders ("CGC") are high energy sources and pose a significant risk in the work place. This section provides employees with information and safe work practices when handling or using compressed gasses.	
8.1.2 Responsibilities	<ol style="list-style-type: none"> 1. The Company is responsible for ensuring that only qualified employees handle or use CGC. 2. The Company is responsible for providing adequate storage and transportation equipment to handle compressed gasses. 3. Employees are responsible for the safe handling and usage of CGC and their contents. 	
8.1.3 Requirements	<ol style="list-style-type: none"> 1. PPE 2. Storage and Handling Equipment 	
8.1.4 Risk Identification	<ol style="list-style-type: none"> 1. Uncontrolled release of cylinder contents resulting in fire, explosion or personal injury. 2. Inhalation of harmful compressed gasses. 3. Exposure to cold vapors of the compressed gas resulting in thermal burn. 	
8.1.5 Safe Work Practices	<ol style="list-style-type: none"> 1. General: <ol style="list-style-type: none"> a. A sign of "Danger - No Smoking, Matches or Open Flame" or equivalent wording shall be conspicuously posted in rooms or at entrances to areas where compressed fuel gas is either used or stored. b. CGC shall be properly labeled including the trade name or chemical name of the gas. c. CGC shall be equipped with pressure relief devices. d. Employees shall never tamper, alter or modify the pressure relief devices. e. CGC shall be visually inspected prior to use to ensure they are in safe condition. f. A leaking CGC shall not be used. Such cylinders shall be taken outdoors away from any source of ignition and reported to a supervisor. g. CGC shall not be used as rollers, supports or for any purpose other than to store compressed gasses. h. CGC shall not be placed where they can become part of an electrical circuit. i. Never use oil, grease, or any material on any apparatus or threaded fittings in the oxygen-acetylene or oxygen-fuel gas 	

system.

- j. Only approved gas welding apparatus shall be used and shall be properly installed and in good working condition.
- k. Oxygen and acetylene or other fuel gases shall be used with the appropriate torches and tips.
- l. Make sure that all connections are tight before lighting the torch.
- m. Never use acetylene at a pressure in excess of 15 pounds per square inch.
- n. Oxygen shall not be used for "AIR" in any way.
- o. Do not mix gases in a cylinder or transfer gas from one cylinder to another (SF6 is exempt from this requirement).

2. PPE

- a. Proper PPE shall include, at a minimum:
 - i. safety glasses
 - ii. protective footwear
 - iii. gloves
 - iv. for welding and cutting PPE see **Section 8.2.4**
 - v. hearing protection, as needed

3. Fire Hazards

- a. Do not use an open flame to detect gas leaks.
- b. Use a non-petroleum based soap solution to detect leaks.
- c. CGC shall be kept away from heat and from welding or cutting operations where sparks could reach them.
- d. Do not allow flame cut sparks to hit hoses, regulators or cylinders.
- e. Oxygen cylinders shall not be stored near highly combustible materials, especially oil and grease.

4. Handling and Storage of CGC

- a. Care shall be exercised when handling all CGC. They shall not be dropped or jarred.
- b. Store CGC in a safe, well ventilated place.
- c. Acetylene and oxygen cylinders in storage must be kept apart by a distance of 20 feet or by use of a properly constructed non-combustible barrier at least five feet high.
- d. CGC shall be fastened in position on approved transporting devices when transported from storage to job site.
- e. CGC, whether full or empty, should be secured in an upright position at all times except, if necessary, for short periods of time while cylinders are being hoisted or carried.
- f. CGC shall be secured in an upright position with regulators removed and valve protection caps in place while being transported.
- g. Before the regulator is removed from a compressed gas cylinder, the valve shall be closed and all pressure released from

	<p>the regulator.</p> <ul style="list-style-type: none"> h. All fittings on CGC and regulators shall be wiped with a CLEAN cloth prior to assembly. <i>(Use of oily cloth on oxygen cylinders may result in an explosion).</i> i. Only approved regulators shall be installed. Regulators shall match the application of the task to be completed. j. Employees shall never force connections that do not fit. k. Regulators shall be placed in a clean location for storage or transportation. l. Before connecting regulators to CGC, stand with the cylinder fittings facing away from you and crack the valve slightly then close tightly to prevent debris from being blown into the regulator. m. The valves of CGC shall be opened slowly with proper tools. Do not use excessive force when turning valve handles. n. Lifting CGC and/or gas welding equipment by hoists or cranes shall be done in accordance with all applicable standards. o. Valve protection caps shall be kept in place except while regulators and hoses are attached. p. When a container or valve is noticeably corroded, notify the gas supplier and follow their instructions. q. Do not direct compressed gas streams toward any person, as it could result in serious injury to the eyes or body. r. When CGC is empty, close the valve, secure the protective cap, and mark the cylinder "EMPTY". <p>5. SF6 Gas Insulated Equipment</p> <ul style="list-style-type: none"> a. The use of PPE (such as gloves, goggles, and apron) rated for acidic or corrosive environments shall be used during cleaning and maintenance of SF6 equipment. b. SF6 gas can cause asphyxiation by displacing oxygen in air. c. Lower fluorides of sulfur, some of which can be toxic, may be produced if SF6 is subjected to electrical discharge. d. When subjected to an electrical discharge, SF6 may be partially degraded and create acidic and possibly corrosive products. e. Inhalation of the gas after electrical discharge shall be avoided.
<p>8.1.6 Definitions</p>	<p>Acetylene: a colorless gas widely used in metal cutting operations.</p> <p>Asphyxiation: to prevent breathing.</p> <p>Oxygen: a gas used in metal cutting operations.</p> <p>SF6: sulfur hexafluoride, an insulating gas used in electrical equipment.</p>

Section 8	Compressed Gasses and Welding	
8.2	Welding, Cutting and Brazing	Effective Date: 1/1/2016 Revised: 1/1/2017
8.2.1 Purpose	To provide employees with information and safe work practices when welding, cutting or brazing.	
8.2.2 Responsibilities	<ol style="list-style-type: none"> 1. The Company is responsible for providing proper training. 2. The employee is responsible for performing welding, cutting and brazing operations safely. 	
8.2.3 Requirements	<ol style="list-style-type: none"> 1. PPE 2. Storage and Handling Equipment 	
8.2.4 Risk Identification	<ol style="list-style-type: none"> 1. Fire Hazards 2. Explosive Hazard 3. Uncontrolled Release of Compressed Gas Cylinder Contents 4. Suffocation 5. Frostbite 6. Flash exposure to the eyes 7. Air Quality 8. Noise 9. Electrical Shock 	
8.2.5 Safe Work Practices	<ol style="list-style-type: none"> 1. PPE <ol style="list-style-type: none"> a. Proper PPE shall include, at a minimum: <ol style="list-style-type: none"> i. safety glasses ii. protective footwear iii. FR clothing iv. hearing protection, as needed v. approved welding helmet vi. welding gloves vii. welding screens viii. aprons b. PPE for welding, cutting, and brazing activities shall be used in accordance with the manufacturer's guidelines. 2. Fire and Explosion Hazards (Hot Work Hazards) <ol style="list-style-type: none"> a. A suitable fire extinguisher shall be present and immediately available for use when welding, cutting, or brazing. b. A hot work checklist should be used and is available on the grid at the Versant Power Safety Page c. Maintain a safe distance between hot work operations and combustibles. d. If unable to maintain a safe distance, use approved welding blankets and screens to properly isolate hot work from 	

combustibles.

- e. A mandatory fire watch is required where combustible material presents a serious fire hazard.
 - i. Assign a designated fire watch to the hot work operation before the work is started.
 - ii. Maintain a continuous fire watch for at least one hour.
 - iii. Monitor the area for up to three additional hours, depending on local conditions.
- f. Either eliminate explosive atmospheres (dust or vapor) or prohibit hot work.
- g. Welding, cutting or other hot work shall not be performed on used drums, barrels, tanks, or other containers unless they are cleaned and tested for the absence of combustible vapors.
- h. Weld substation equipment in accordance with the equipment manufacturer's instructions.
- i. Secure, isolate and vent pressurized vessels, piping and equipment as needed prior to conducting hot work.
- j. Clean ignitable liquids, flammable gases and combustible solids from the equipment prior to conducting hot work.
- k. Remove matches and lighters from all pockets before welding operations.

3. Arc and Gas Welding, Cutting and Brazing

- a. Only qualified workers shall use welding equipment.
- b. Protective equipment for welding, cutting or brazing includes:
 - i. Face protection.
 - ii. Appropriate welding helmet and shading for each application.
 - iii. Welding screens used to protect other workers from welding flashes.
 - iv. Eye protection, when shade protection is removed or raised.
 - v. FR clothing rated for the work
- c. Use adequate local exhaust ventilation and/or respiratory protection, as required per OSHA 1910 subpart Q (1910.252(c)).
- d. When working overhead, adequate protection shall be provided for other workers below.
- e. Use properly marked hoses for oxygen-acetylene systems and equip them with backflow protective valves at the nozzle end of the hose.
- f. Keep work area clean and free from hazardous materials when flame cutting.
- g. Do not use a windbreak that is enclosed on all sides.
- h. Protect electrical cables or fuel hoses from physical damage with approved barriers or covers.
- i. For safety practices on handling and storage of compressed gas cylinders, refer to **Section 8.1 Compressed Gas Cylinders**.
- j. Electrode holders, when not in use, shall be placed so they

	<p>cannot make electrical contact with persons, conducting objects, fuel or compressed gas cylinders.</p> <ul style="list-style-type: none"> k. When an arc welding machine is to be moved or work is otherwise interrupted, the welding machine's power supply switch shall be turned off. l. Wire stubs shall be disposed of in a proper container. <p>4. Torches</p> <ul style="list-style-type: none"> a. Torches are to be used only by qualified personnel. b. Do not use matches or lighters to light the torch. c. Do not light torches inside enclosures containing flammable vapors and/or gases. d. When using torches in manholes, provide adequate ventilation for employees and for combustion. e. Never leave a torch unattended where it could cause a fire.
8.2.6 Definitions	Fire Watch: an employee designated to watch for unplanned fire during hot work activity.

Section 9	Fleet Maintenance	
9.1	Fleet Maintenance Tools and Equipment	Effective Date: 1/1/2016 Revised:
9.1.1 Purpose	This section provides information and safe work practices to create a safe working environment while performing fleet maintenance activities.	
9.1.2 Responsibilities	<ol style="list-style-type: none"> 1. The Company is responsible for ensuring that only qualified employees work on and maintain the Company's fleet. 2. The Company is responsible for providing the proper special tooling to maintain the Company's fleet. 3. The employee is responsible for following safe work practices when working with fleet equipment. 4. The employee is responsible for using and maintaining Company or individually owned hand tools. 	
9.1.3 Requirements	<ol style="list-style-type: none"> 1. PPE 2. Fleet Maintenance Tools and Equipment 3. Exhaust Ventilation System 	
9.1.4 Risk Identification	<ol style="list-style-type: none"> 1. Personal injury due to equipment failure. 2. Inhaling harmful exhaust fumes. 3. Elevated loads causing overhead or falling hazards. 4. Eye injuries from chemical fluids or debris. 	
9.1.5 Safe Work Practices	<ol style="list-style-type: none"> 1. General <ol style="list-style-type: none"> a. Only qualified employees shall operate fleet maintenance tools and equipment. b. Tools and equipment shall be operated according to the manufacturer's guidelines. c. Tools and equipment shall be inspected prior to use. d. Defective tools and equipment shall not be operated and shall be reported immediately for repair or replacement. e. Employees shall familiarize themselves with the location of the nearest eyewash station. f. All garage doors shall be fully opened or closed to avoid overhead hazards. g. Wheel chocks and jack stands shall be used when lifting vehicles with manual jacks. 2. Hydraulic Lifts <ol style="list-style-type: none"> a. Lifts shall be inspected and signed off daily prior to use. b. Employees should not stand directly in front of vehicles when directing them onto the lift. c. Vehicles shall be properly placed and wheel chocks deployed prior to operating the lift. 	

	<ul style="list-style-type: none"> d. Only unoccupied vehicles shall be raised or lowered. e. The lift controls shall be manually operated and not blocked or locked in the operating position. <p>3. Tire Mounting</p> <ul style="list-style-type: none"> a. Tire mounting tools shall be in good condition; not damaged, dented or deformed. b. Remove the valve core to release all air from the tire before demounting. c. Securely lock the wheel into place before attempting to seat the bead. d. Do not stand over the tire while inflating. e. Do not inflate the tire beyond the recommended pressure. <p>4. Truck Washing</p> <ul style="list-style-type: none"> a. Proper PPE shall be worn when using a pressure washer. b. Refer to the applicable SDS sheets when handling chemicals used in pressure washing. c. Never point the pressure washer at yourself or others. d. Never attempt to push or move objects with a pressure washer. e. Ensure that electric pressure washers are plugged into a ground-fault circuit interrupter (GFCI) receptacle. <p>5. Exhaust Fume Ventilators</p> <ul style="list-style-type: none"> a. No vehicle shall be left running in garages unless proper ventilation equipment is attached. b. Ventilators shall be operated in accordance with the manufacturer’s recommendations. c. Vehicles with dual exhaust pipes shall have both pipes connected to the ventilation system, if necessary. d. Hoses and couplings may be hot. Care shall be taken when removing hoses and/or couplings from any vehicle which has been running.
<p>9.1.6 Definitions</p>	<p>Jack Stands: a stand whose height may be adjusted and which is used to support an automobile that has been raised by a jack.</p> <p>Safety Data Sheet (SDS): a formal document containing important information about the characteristics and actual or potential hazards of a substance.</p>

Section 9	Fleet Maintenance	
9.2	Battery Maintenance	Effective Date: 1/1/2016 Revised: 1/1/2017
9.2.1 Purpose	This section provides information and safe work practices to safely perform maintenance on fleet batteries.	
9.2.2 Responsibilities	<ol style="list-style-type: none"> 1. The Company is responsible for ensuring that only qualified employees perform battery maintenance. 2. The Company is responsible for providing the proper tools to maintain batteries. 3. The employee is responsible for following safe work practices when performing battery maintenance. 	
9.2.3 Requirements	<ol style="list-style-type: none"> 1. PPE 2. Deionized water 3. Safety Data Sheet ("SDS") for battery chemicals 4. Battery charging equipment 	
9.2.4 Risk Identification	<ol style="list-style-type: none"> 1. Exposure to Hydrogen Gas 2. Chemical burns 3. Batteries catching on fire 4. Hydrogen Gas explosion hazards 	
9.2.5 Safe Work Practices	<ol style="list-style-type: none"> 1. General <ol style="list-style-type: none"> a. Always follow the manufacturer's procedures for battery charging rate and time. b. Indoor battery maintenance shall only be conducted in designated areas. c. To prevent sparks, connect and disconnect charger clips only with the charger in the "OFF" position. d. For more information on acid refer to Section 7.4 Acid 2. Jump Starting Batteries <ol style="list-style-type: none"> a. Proper PPE is required when jump starting vehicle batteries to avoid electrolyte contact. <ol style="list-style-type: none"> i. Safety Glasses ii. Gloves iii. Faceshield (unless using an external battery connection) b. Do not lean over batteries when making connections. c. The following steps are for fuel powered vehicles; follow manufacturer's recommendations when jump starting a hybrid or electric vehicle. d. To avoid battery explosion and damage to the alternator, the following jump start sequence shall be used when jump starting vehicles with jumper cables: <ol style="list-style-type: none"> i. Pull the assisting car up to the dead car close enough so the cables can reach. 	

	<ul style="list-style-type: none"> ii. Turn off headlights, blinkers, radios and heating systems and unplug accessories from power sockets on the dead car. iii. Locate the batteries in each car and identify the positive (+) and negative (-) terminals. iv. Identify the jumper cables: red is for the positive charge and black is for the negative. v. Do not let the clamps of the opposing cables touch. vi. Take the red jumper cable and connect one clamp to the positive post of the dead car battery. Connect the other clamp of the red cable to the positive post of the live car battery. vii. Take the black jumper cable and connect one clamp to the negative post of the live car battery. Connect the other clamp of the black cable to an unpainted metal part of the dead car's engine block, such as a bolt. Do <u>NOT</u> connect to the negative post of the dead battery. viii. When jump starting, the assisting car should be running. Start the dead car. Once it starts, leave it running for a few minutes to draw the charge from the assisting battery. ix. With both cars running, remove the cables in the reverse order from which you placed them. x. Report the incident to the Fleet Department by completing a Vehicle Maintenance Request Form. <p>3. Battery Powered Industrial Trucks</p> <ul style="list-style-type: none"> a. Charge in a well-ventilated area to avoid hydrogen gas buildup. b. Open flames shall not be permitted in the vicinity of the battery charging area. c. Wear proper PPE when charging or maintaining batteries to avoid electrolyte contact. d. Do not lay metallic objects on top of batteries. e. Only insulated tools shall be used to maintain batteries. f. If necessary only add enough water to the battery before charging to cover the top of the plates. After charging add water to top off the cell if needed.
<p>9.2.6 Definitions</p>	<p>Deionized Water: a type of purified water with mineral ion (salts) removed.</p> <p>Electric Vehicle: a vehicle that is propelled by one or more electric motors, using electrical energy stored in rechargeable batteries or another energy storage device.</p> <p>Hybrid Vehicle: a vehicle with a gasoline engine and an electric motor, each of which can propel it.</p> <p>Jumper Cables: a pair of thick electric cables fitted with clips at either end, used for starting a vehicle by connecting its dead battery to the battery of another vehicle.</p>

Section 10	Contractor Safety	
10.1	Contractor and Sub-Contractor Safety	Effective Date: 1/1/2018 Revised: 9/15/2020
10.1.1 Purpose	This section provides information regarding contractor and sub-contractor safety.	
10.1.2 Responsibilities	<ol style="list-style-type: none"> 1. The Company is responsible for informing contractors of the Company's safe work practices. 2. The Company is responsible for providing appropriate contractor oversight. 3. Employees are responsible for ensuring that contractors under their supervision follow the Company's safe work practices. 	
10.1.3 Requirements	<ol style="list-style-type: none"> 1. Contractor Safety Plan Compliance(CSP) is found on the grid on the safety page at: http://grid.versantpower.com/se/Pages/maine_safety.aspx <ol style="list-style-type: none"> a. Contractors must follow guidelines as detailed in Contractor Safety Plan including: <ol style="list-style-type: none"> i. Complete and sign HSE Safety data to qualify for work – Appendix 3 of CSP. ii. Following phases of contract as detailed in CSP. iii. Provide on-going safety data during work. iv. Sign Contractor Signature/Acknowledgement at end of CSP to acknowledge understanding and compliance. b. Versant Power Supervisors/Managers overseeing contractor work must ensure contractors are following the CSP guidelines. 	
10.1.4 Risk Identification	<ol style="list-style-type: none"> 1. Company Liability 2. Contractor unfamiliar with safe work practices 3. Employee or contractor personal injury or property damage 	
10.1.5 Safe Work Practices	<ol style="list-style-type: none"> 1. Questions or concerns regarding contractor safety practices should be addressed with the Versant Power Supervisor/Manager overseeing the contractor and/or the safety department. 	
10.1.6 Definitions		

Section 11	First Aid/CPR/Bloodborne Pathogens	
11.1	First Aid	Effective Date: 1/1/2016 Revised: 1/1/2017
11.1.1 Purpose	First aid is administered to prevent the worsening of a given condition until the person receives professional medical attention. This section provides protocols for a certified First Aid Provider when administering aid to persons with injuries and illnesses.	
11.1.2 Responsibilities	<ol style="list-style-type: none"> 1. The Company is responsible for providing training every two years to those employees required to receive such training. 2. The essential responsibilities of a First Aid Provider are: <ol style="list-style-type: none"> a. Identify medical emergency b. Take appropriate action c. Identify hazards and ensure personal safety d. Activate EMS (dial 911) e. Provide basic first aid care 	
11.1.3 Requirements	<ol style="list-style-type: none"> 1. First Aid Certification 2. First Aid Kit 3. PPE 	
11.1.4 Risk Identification	<ol style="list-style-type: none"> 1. Unqualified employee performing First Aid. 2. Working in an unsafe scene. 	
11.1.5 Safe Work Practices	<ol style="list-style-type: none"> 1. Positions Requiring First Aid Training <ol style="list-style-type: none"> a. Only employees who have been trained and certified shall perform First Aid. b. The Company has determined the following job classifications shall be trained and certified in First Aid: <ul style="list-style-type: none"> ➤ Stock Room Employees ➤ Line & Meter Department Employees ➤ Power Systems Technical Employees ➤ Fleet & Safety Lab Employees ➤ T&D Construction Planning Employees 2. Personal Protective Equipment <ol style="list-style-type: none"> a. A minimum of nitrile rubber medical gloves and safety glasses shall be worn at all times while providing care. Employees shall avoid contact with bodily fluid whenever possible. b. All employees shall dispose of PPE properly and immediately wash hands with soap and water after care is finished. 3. Abdominal Pain <ol style="list-style-type: none"> a. <u>Signals of a serious abdominal injury:</u> 	

Open wound in abdomen, severe pain, bruising, external bleeding, nausea and vomiting, weakness, thirst, pain/tenderness or a tight feeling in the abdomen.

b. Care for a serious abdominal injuries:

Carefully position victim on his/her back, do NOT apply direct pressure to open wounds.

Bend victim's knees slightly unless movement causes pain and place a rolled up blanket or pillow under the knees.

Apply sterile dressing to open wounds, but do NOT apply direct pressure, and treat for shock.

Monitor airway, breathing, circulation and level of Consciousness.

4. Abrasions

a. Care for abrasions:

Wash wound with soap and water.

Control bleeding with direct pressure.

Place triple antibiotic on wound if no allergy.

Apply sterile dressing.

Advise patient to get tetanus shot if greater than 10 years since last shot.

5. Allergic Reactions

a. Signals of allergic reactions:

Anaphylactic shock is a severe allergic reaction.

Air passages may swell and restrict the victim's breathing.

Insect stings, food or medication may cause anaphylaxis.

Signals are rash, feeling of tightness in chest and throat, swelling of face, neck and tongue, dizziness or confusion and breathing difficulty which may include coughing and wheezing.

b. Care for allergic reactions:

Monitor breathing closely, provide respiratory support and treat for shock.

6. Back Pain

a. Signals of back pain:

There are many causes of back pain including fractures, tumors, infections, disc herniation, soft tissue strain (muscle, tendon, and ligament), internal illness and cardiac emergencies.

b. Care for back pain:

Have victim stop performing any aggravating activities and assume a position of comfort.

7. Bite Wounds

a. Care for animal/human bites:

Wash thoroughly with soap and water.

Apply ice if area is swelling.
Advise victim to get tetanus shot if longer than ten years.
Consider assessment for possible exposure to rabies, arrange for medical care.

b. Care for insect bites:

Determine if victim is allergic, if victim is allergic or there are signs of an allergic reaction.

- Dial 911
- Monitor airway, breathing, circulation and level of consciousness.
- Treat for shock.
- If not allergic and no signs of allergic reaction remove stinger if readily accessible, wash thoroughly, apply ice.

8. Bruises

a. Care for bruises:

Apply a cold compress or ice packs to affected area.
Reapply ice packs for up to 20 minutes per hour every two to four hours during the first 48 hours after the injury.
Elevate and rest the injured part and seek medical attention if needed.

9. Burns

Burns are soft tissue injuries caused by heat, chemicals, electricity or radiation

a. Signals of burns:

- *Superficial burns* involve only the top layer of skin. The skin is usually red and dry and the burn is painful.
- *Partial Thickness burns* involve top and middle layers of skin and will usually appear red and blistered. The blisters may weep and make the skin appear wet.
- *Full Thickness burns* may destroy skin and underlying structures such as fat, muscle, bone and nerves. These burns look brown or charred with tissue underneath sometimes appearing white.
- *Critical burns include:* burns where the victim is experiencing difficulty breathing, burns involving more than one body part, burns to the head, neck, hands, feet or genitals, any partial or full thickness burn to a child or elderly person, burns resulting from chemical exposure or electricity.

b. Treatment:

- Remove clothing in affected area, irrigate with low-pressure cool water, cover burned area with sterile, loose bandages, and arrange for medical attention.

- For critical burns, dial 911, monitor airway, breathing, circulation, level of consciousness and treat for shock.

10. Cardiac Emergencies

a. Signals of a cardiac emergency:

Persistent chest, neck, jaw or upper back pain (particularly in females) or discomfort, difficulty breathing, pale or bluish skin or lips, sweating, nausea, unconsciousness, no pulse, not breathing.

b. Treatment:

- Dial 911
- Look for and recognize signs and symptoms,
- Have victim assume a position of comfort, loosen clothing, reassure victim, treat for shock.
- If patient is unconscious assess for breathing and pulse, deploy AED, and perform CPR.

11. Convulsion/Seizure

a. Care for convulsion/seizure:

Protect the victim from being injured by his/her environment. Monitor airway, breathing, circulation, state of consciousness. Treat for shock.

12. Diabetic Emergencies

Signals of a diabetic with too much sugar (hyperglycemia) and too little sugar (hypoglycemia) are very similar and include:

Changes in the level of consciousness including dizziness, drowsiness and confusion. Signals also include rapid breathing, rapid pulse, feeling and looking ill, feeling weak or light-headed.

a. Treatment for conscious victim:

- Determine if they have a medical history of diabetes,
- Ask if he/she has taken their insulin, has failed to eat or has experienced some great emotional stress or done something very physically exerting.
- Give the victim sugar.
- Monitor airway, breathing, circulation, state of consciousness. Treat for shock.

b. Treatment of unconscious victim:

- Look for bracelet or necklace warning victim is diabetic.
- Monitor airway, breathing, circulation, state of consciousness.
- Treat for shock.

13. Electric Shock

a. Treatment for electric shock:

- Do Not Touch The Victim Until The Electrical Current Has Been Turned Off.
- Dial 911
- Assess airway, breathing, circulation, begin CPR if necessary and deploy AED.
- If breathing, monitor airway, breathing, circulation, state of consciousness and treat for shock.

14. Eye Injuries

a. Treatment for foreign bodies in the eyes:

- Foreign bodies that get in the eye such as dirt, sand or fibers are irritants and may cause significant damage.
- First try to remove the foreign body by telling the victim to blink several times.
- Next flush the eye with water.
- Seek medical attention if the irritation does not cease.

b. Treatment for chemicals in eyes:

- Dial 911, and
- Flush eyes with water.

15. Fainting

a. Signals of fainting:

Fainting is a partial or complete loss of consciousness that is caused by a temporary reduction of blood flow to the brain.

b. Care for fainting:

- Assist the victim to a position of comfort.
- Loosen any restrictive clothing.
- Monitor airway, breathing, circulation, state of consciousness. Treat for shock.

16. Fractures and Dislocations

a. Signs of fracture/dislocation:

- Deformity, swelling and discoloration
- Inability to move or use the affected body part
- Bone fragments protruding from the wound
- Loss of circulation in an extremity

b. Treatment:

- Rest the affected part
- Apply ice to areas of swelling/deformity
- Elevate if possible
- Immobilize the injured part
- Arrange for medical treatment
- Monitor airway, breathing, circulation, state of consciousness Treat for shock.

17. Head Injury

a. Care for head injury:

- Dial 911
- Minimize head and neck movement, monitor airway, breathing, circulation, state of consciousness.
- Treat for shock

18. Lacerations

a. Care for lacerations:

- Control bleeding by using direct pressure and elevation.
- Apply dressing and bandage when bleeding is under control.
- Monitor airway, breathing, circulation, state of consciousness and treat for shock.

19. Nosebleed

a. Care for nosebleed:

- Pinch nose together over soft tissues continuously for 20 minutes.
- Keep victim in sitting position with head forward.
- Seek medical attention if bleeding continues.

20. Person Down

- a. Dial 911
- b. If called to a situation where a person is down, STOP and be sure the incident location is safe for you to enter.
- c. If it is safe to enter look around and attempt to determine what has happened.
- d. Evaluate the Down Victim:
 - Shake and Shout are You Okay
 - Head Tilt/Chin Lift to open Airway
 - Is he/she breathing
 - If not attempt Rescue Breathing
 - If so, check pulse
 - If no pulse, begin CPR, deploy AED
 - Assess Level of Consciousness
 - Awake and Alert
 - Responds To Voice
 - Responds to Pain
 - Unresponsive

21. Shock

Shock is a condition in which the circulatory system fails to circulate oxygen-rich blood to all parts of the body. When vital organs do not receive oxygen-rich blood they fail to function properly.

Shock may result from loss of body fluid from severe bleeding, from

hypoglycemia, anaphylaxis, and severe damage to the heart or blood vessels, heat stroke, severe infection, drugs or poisoning.

a. Signals of shock:

Restlessness or irritability, rapid, weak pulse, rapid breathing, pale, bluish skin, cool, moist skin, excessive thirst, nausea/vomiting, faint feeling, drowsiness or loss of consciousness, high blood pressure.

b. Treatment for shock:

- Dial 911
- Monitor airway, breathing, circulation, state of consciousness. Control any external bleeding.
- Do not give the victim anything to eat or drink even though he/she is likely to be thirsty.

22. Stroke

A stroke, or cerebral vascular accident, is a disruption of blood flow to a part of the brain that is serious enough to damage brain tissue. Most commonly a stroke is caused by a blood clot but another common cause is bleeding from a ruptured artery in the brain.

a. Signals of stroke:

- Victim looks ill and complains of feeling ill.
- Victim displays abnormal behavior.
- Victim has sudden weakness and numbness in the face, arm or leg; usually on one side of the body.
- Victim has difficulty speaking or understanding speech.
- Victim has blurred or dimmed vision, sudden and severe headache, dizziness, confusion or ringing of ears.

b. Treatment:

- Dial 911
- Monitor airway, breathing, circulation, state of consciousness. Treat for shock.

23. Transportation by Ambulance

a. Dial 911 any time the victim is experiencing:

- Moderate or severe difficulty breathing
- Chest Pain
- Uncontrolled Bleeding
- Signs of Shock
- Acute pain that is debilitating
- Moderate to severe systemic allergic reactions
- Electric Shock
- Moderate to severe burns
- Moderate to severe head injury
- You are uncomfortable in determining what is wrong or

	what to do.
11.1.6 Definitions	<p>AED: Automated External Defibrillator</p> <p>CPR: Cardiopulmonary Resuscitation</p> <p>EMS: Emergency Medical Services</p> <p>First Aid Provider: a person who is trained in the delivery of initial emergency procedures, using limited equipment to perform a primary assessment and intervention until Emergency Services, or EMS personnel arrives.</p>

Section 11	FIRST Aid/CPR/Blood borne Pathogens	
11.2	Cardiopulmonary Resuscitation (CPR) Automatic External Defibrillator (AED)	Effective Date: 1/1/2016 Revised: 1/1/2017
11.2.1 Purpose	This section provides protocols for a certified First Aid Provider when administering CPR and AED to persons who have become unconscious and are found to be without a pulse.	
11.2.2 Responsibilities	<ol style="list-style-type: none"> 1. The essential responsibilities of a certified First Aid Provider are: <ol style="list-style-type: none"> a. Identify medical emergency. b. Take appropriate action. c. Identify hazards and ensure personal safety. d. Activate EMS (dial 911). 	
11.2.3 Requirements	<ol style="list-style-type: none"> 1. CPR/AED Certification 2. PPE 3. First Aid Kit 4. AED 	
11.2.4 Risk Identification	<ol style="list-style-type: none"> 1. Unqualified employee performing CPR/AED 2. Working in an unsafe scene 	
11.2.5 Safe Work Practices	<ol style="list-style-type: none"> 1. Job Classifications Requiring CPR/AED Training. <ol style="list-style-type: none"> a. Only employees who have been trained and certified shall perform CPR/AED. b. The Company has determined the following job classifications shall be trained and certified in CPR/AED. <ol style="list-style-type: none"> i. Stock Room employees ii. Line & Meter Department Employees iii. Power Systems Technical Employees iv. Fleet & Safety Lab Employees v. T&D Construction Planning Employees 1. Personal Protective Equipment <ol style="list-style-type: none"> a. PPE shall be found in first aid kits available throughout the workplace where employees are located. PPE shall include, but is not limited to, disposable latex-free medical gloves, CPR breathing barriers, and antiseptic towelettes. b. Safety glasses shall be worn at all times while providing care. c. Refer to Section 11.3 Blood borne Pathogens Policy for information on avoiding exposure to potentially infectious materials. 2. Checking an Unconscious Adult <ol style="list-style-type: none"> a. Ensure the scene is safe. 	

- b. Assess the person.
- c. Tap on their shoulder and shout “Are you OK?”
- d. No response dials 911.
- e. Open airway (tilt head, lift chin) Take 5 to 10 seconds (no more than 10 seconds) for the signs of breathing.
- f. If not breathing, begin providing rescue breathing.
- g. If breathing, place in recovery position and monitor for airway, breathing and circulation.

3. Steps for Adult CPR

- a. Make sure the scene is safe.
- b. Tap on their shoulder and shout “Are you OK?”
- c. If the victim does not respond and the victim is not breathing or not breathing normally:
 - i. Ask someone to dial 911 and get an AED, if available.
 - ii. If you’re alone, dial 911 and get an AED if available. Follow the AED’s voice prompts.
 - iii. If no AED is available, immediately start CPR, beginning with compressions.
- d. Push hard and fast on the center of the chest 30 times, at a rate of at least 100 compressions a minute. Push down at least 2 inches with each compression.
 - i. If you haven’t been trained in CPR, continue to give compressions until an AED arrives or trained help takes over.
 - ii. If you are unable or unwilling to give rescue breaths, perform compression-only CPR.
 - iii. If you have been trained in CPR, continue CPR by opening the airway with a head tilt/chin lift.
- e. Pinch the victim’s nose closed.
- f. Take a normal breath and cover the victim’s mouth with your mouth, creating an airtight seal.
- g. Give two breaths (one second each).
- h. Watch for chest to rise as you give each breath.
- i. Keep giving sets of 30 compressions and two breaths until the person shows signs of life, another provider or EMS personnel take over, or you are too exhausted to continue.

4. Automatic External Defibrillator

- a. Turn on the AED by opening the lid or, where provided, by pressing the power button.
- b. Follow the voice prompts.
- c. Perform CPR, if possible, until the pads are in place and AED is ready to analyze the heart rhythm.
- d. If needed, quickly tear or use scissors to remove clothing, including undergarments. Defibrillation pads must be applied to a bare chest.
- e. If the chest is sweaty, wipe it dry with removed shirt, a dressing

	<p>or a towel.</p> <ul style="list-style-type: none"> f. Peel the pads from the backing sheet one at a time and place them <u>exactly</u> as indicated in the pictures provided on the pads. g. Make sure the pads adhere well by pressing them flat. h. AED will automatically start analyzing once the pads are in place. Movement can interrupt the analysis. i. If defibrillation is required, AED will charge to deliver a shock. j. Before delivering the shock, make certain that no one is in contact with the person including you. k. Give a verbal warning, look to make sure no one is in contact with person, deliver shock. l. Immediately after delivering the shock, resume CPR, starting with chest compressions. m. If the person responds, stop CPR and place them in a recovery position. n. Leave the AED on and attached in case cardiac arrest returns. o. When a shock is not indicated by the AED, simply resume CPR, starting with chest compressions and continue to follow any voice instructions. Don't stop until the person shows signs of life, another provider or EMS personnel take over, or you are too exhausted to continue.
<p>11.2.6 Definitions</p>	<p>AED: Automatic External Defibrillator</p> <p>CPR: Cardiopulmonary Resuscitation</p> <p>EMS: Emergency Medical Services</p> <p>PPE: Personal Protective Equipment</p>

Section 11	First Aid/CPR/Bloodborne Pathogens	
11.3	Bloodborne Pathogens Policy	Effective Date: 1/1/2016 Revised: 1/1/2018
11.3.1 Purpose	<p>The purpose of this Policy is to eliminate or minimize employee occupational exposure to blood or certain other potentially infectious materials, which may contain bloodborne pathogens and could cause harm to an exposed employee.</p> <p>This Policy is in accordance with OSHA Bloodborne Pathogen Standard (29 C.F.R. 1910.1030).</p>	
11.3.2 Responsibilities	<ol style="list-style-type: none"> 1. The Company is responsible for complying with OSHA standards. 2. The Company is responsible for providing appropriate training to employees. 3. The Company practices Universal Precautions, as recommended by the Centers for Disease Control (CDC). 4. Employees are responsible for following the OSHA standards and Company policy and procedures. 	
11.3.3 Requirements	<ol style="list-style-type: none"> 1. PPE 2. Bloodborne Pathogen Kit 3. First Aid Kit 	
11.3.4 Risk Identification	<ol style="list-style-type: none"> 1. Exposure to infectious diseases 	
11.3.5 Safe Work Practices	<ol style="list-style-type: none"> 1. Application This policy applies to all employees who may, in the course of performing their normal occupational duties, anticipate exposure to blood, blood products and/or other potentially infectious material containing, but not limited to, organisms such as H.I.V., H.B.V. and H.C.V. 2. Policy Review This policy is reviewed annually and shall be revised to reflect new or modified tasks, procedures and positions which affect occupational exposures to potentially infectious materials. 3. Accessibility of Policy This Policy is provided to all employees in the Safety Manual Binder which is also available electronically on the Grid. http://grid.versantpower.com/se/Pages/maine_safety.aspx 4. Occupational Exposure Determination. <ol style="list-style-type: none"> a. The Company has determined the following job classifications 	

may have the potential for occupational bloodborne pathogen exposure.

- i. Stock Room Employees
- ii. Line & Meter Department Employees
- iii. Power Systems Technical Employees
- iv. Fleet & Safety Lab Employees
- v. T&D Construction Planning Employees

5. Training Requirements

- a. This Policy shall be provided to all employees at the time of hire.
- b. All employees who have the potential for occupational bloodborne pathogen exposure shall be trained at the time of initial assignment and at least annually thereafter.
- c. Annual training shall incorporate all updated material and may review information previously presented.
- d. Training material shall be provided in content and vocabulary to the educational level, literacy and language of employees.
- e. Training sessions are conducted during normal work hours and at no charge to the employee.

6. Personal Protective Equipment

- a. When there is a potential for exposure, appropriate personal protective equipment ("PPE") shall be used. PPE is provided in the first aid kits and bloodborne pathogens kits available throughout the workplace where employees are located.
- b. PPE shall include, but is not limited to, disposable latex-free medical gloves, CPR breathing barriers and antiseptic towelettes.
- c. Safety glasses shall also be worn when exposed to potentially infectious material.

7. Engineering and Work Practice Controls

a. Procedure:

The Company utilizes the engineering and work practice controls described below:

- i. Use of tongs when cleaning up sharp or broken objects (e.g. Glass) or Kevlar cut-proof gloves when handling broken glass or needles.
- ii. Re-examination and maintenance/replacement of engineering controls (eg. First aid kits) performed on a regular basis.
- iii. Regular inspections and restocking documented on the form associated with each kit, at a minimum of once a year.
- iv. Employees shall immediately wash hands following a potential exposure. In the absence of a facility to wash hands, antiseptic towelettes, waterless gel or foam, or equivalent, shall be made available to all employees.

Note: Gloves are not considered a substitute for hand washing.

Hands shall still be washed after the removal of gloves that have been contaminated with blood or other potentially infectious material.

8. Housekeeping

a. General procedures for cleaning spills

- i. All equipment and environmental working surfaces are cleaned and decontaminated after contact with blood or other potentially infectious materials.
- ii. The following disinfectants can be used for decontamination:
 - Household bleach in water. (1 part bleach to 10 parts water)
 - Clorox Disinfecting Wipes or equivalent
- iii. The Manager of Safety is to be notified of any incident where employees are exposed to bloodborne pathogens or other potentially infectious material.

b. Specific clean-up procedures

- i. **Minor Spills**
 - Trained company personnel equipped with the proper personal protective equipment, materials and decontamination products shall clean-up minor events involving potentially infectious material.
 - Bloodborne pathogens kits are located in facilities where employees are located.
- ii. **Major Spills**
 - Any major event involving a significant bloodborne pathogen or other potentially infectious material shall be handled by a sub-contractor who specializes in clean-up of bloodborne pathogens or potentially infectious material.

c. Procedure For Minor Cleanup:

- i. Obtain Spill Kit.
- ii. Put on gloves and eye protection.
- iii. Completely cover the spill with absorbent compound.
- iv. When the spill forms into a semi-solid mass, use the spatula to place the congealed fluid into the disposal bag
- v. Seal the bag tightly.
- vi. Apply germicidal agent on the contaminated area.
- vii. Dispose of all material (white bag, spatula, plastic bottle, wipes, spill kit and gloves) in a garbage bag, which will be immediately deposited in a dumpster on site.
- viii. Remove any contaminated rental clothing and place in red bag supplied by Cintas. Red Cintas bags are in uniform storage rooms and will be picked up by the delivery driver

and taken to be washed.

- ix. Remove personal protective equipment and dispose of in the same manner as in c vii above.
- x. Wash hands or rinse hands with antiseptic towelette/hand rinse and allow to dry.
- xi. Contact the Manger of Safety for assistance in disposing of the red bag and for laundering of any contaminated clothing.

d. Procedure For Major Clean-up

- i. Isolate the area.
- ii. Keep all personnel away.
- iii. Contact the Manager of Safety or Facilities Manager to coordinate a sub-contractor who specializes in clean-up of bloodborne pathogens or potentially infectious material.

9. Hepatitis B Vaccination and Post-exposure Evaluation

a. General

- i. The Hepatitis B vaccination series shall be made available to all employees who have the potential for occupational exposure within ten working days of determination of exposure.
- ii. The vaccine is automatically offered as part of the post-exposure evaluation and follow-up.

b. Hepatitis B Vaccination Program

- i. The vaccine is offered free of charge including all lab tests to determine immunity.
- ii. Vaccination is performed under the supervision of a Physician or Licensed Health Care Provider.
- iii. Hepatitis B vaccines are provided according to the recommendations of the U.S. Department of Health and Human Services Immunization Practices Advisory Committee.
- iv. Employees may initially decline the Hepatitis B vaccine.
- v. Any time thereafter, Employees may choose to receive the vaccine if the potential exposure still exists.
- vi. The vaccination shall be provided at that time to the employee at no cost to that employee.
- vii. Employees who decline vaccination are required to sign a Hepatitis B Vaccine Declination Form (Attachment A).
- viii. In the event that a booster dose of Hepatitis B vaccine is recommended by the Centers for Disease Control or the Physician or Licensed Health Care Provider, this booster shall be arranged by the Human Resources Department and provided at no cost to the employee.

c. Post-exposure Evaluation and Follow-up

i. General

- An “Exposure Incident” means a specific eye, mouth, mucous membrane, non-intact skin, or parenteral contact with blood or other potentially infectious materials.
- Employees are to report all exposure incidents as defined above immediately to their Supervisor. If exposure is questionable, the immediate supervisor shall seek guidance from the Human Resources Department who may consult with the preferred Occupational Health Medical Provider.

ii. Course of Action/Follow-up

- All exposures are to be referred to the Human Resources Department.
- An Incident/Accident Report will be submitted immediately to the Safety and Human Resources Department and copied to the Occupational Health Medical Provider.
- The injury report shall include the exposure route and type, circumstances surrounding the exposure event and source of exposure.
- Refer to **Section 2.1 for Safety Reporting.**
- Post-exposure care shall be offered immediately (within 24 hours) and be provided by Occupational Health Medical Provider or local emergency room.

10. Recordkeeping

a. Medical Records

- i. Medical Records for all occupational exposures to potentially infectious materials contain the information described below:
 - Name and Social Security Number (or equivalent patient identification number)
 - Hepatitis B vaccination status, including vaccine series dates
 - Medical records relevant to the employee’s ability to receive vaccination
 - A copy of all results of examinations, medical testing and follow-up procedures as described in this Policy.
- ii. Occupational Health Medical Provider shall maintain all medical records pertaining to exposure to potentially infectious material. These records, testing results and treatment, shall be maintained in a confidential manner and shall only be released with the specific written release of the employee.
- iii. Employees exposed to potentially infectious material shall be examined by a Physician or Licensed Health Care

	<p>Provider who shall issue a written opinion within fifteen days of completion of the evaluation. This medical opinion shall be shared with the employee.</p> <p>iv. The information shared with the Company from this evaluation shall be limited to:</p> <ul style="list-style-type: none"> ➤ Whether or not a Hepatitis B vaccine is indicated and if so, that it was offered. ➤ Confirmation that the employee has been informed of the results of the evaluation. ➤ Confirmation that the employee has been told about any medical conditions resulting from the exposure to blood or other potentially infectious material which requires further evaluation or treatment. <p>v. Under no circumstances shall the Company receive any information pertaining to the medical treatment of the exposed employee other than what is outlined above.</p> <p>vi. The Company shall not in any way discriminate against any employee who, in the course of their duties at work, becomes infected by a bloodborne pathogen after exposure to infectious material.</p> <p>b. <u>Training Records</u></p> <p>i. Training Records shall contain the information described below:</p> <ul style="list-style-type: none"> ➤ Contents and summary of training sessions. ➤ Name and qualifications of persons conducting the training. ➤ Names and job titles of all persons attending the training. <p>ii. Training Records are maintained electronically on the Company's Employee Development System (EDS).</p>
<p>11.3.6 Definitions</p>	<p>Blood: human blood, human blood components and products made from human blood.</p> <p>Bloodborne Pathogens: pathogenic microorganisms that are present in human blood and can cause disease in humans. These pathogens include, but are not limited to, Hepatitis B Virus (HBV), Human Immunodeficiency Virus (HIV) and Hepatitis C Virus (HCV).</p> <p>Contaminated: the presence, or the reasonably anticipated presence, of blood or other potentially infectious materials on an item or surface.</p> <p>Decontamination: the use of physical or chemical means to remove, inactivate, or destroy bloodborne pathogens on a surface or item to the point where they are no longer capable of transmitting infectious particles and the surface or item is rendered safe for handling, use or disposal.</p>

Engineering Controls: means controls (e.g., sharps disposal containers, self-sheathing needles, safer medical devices, such as sharps with engineered sharps injury protections and needleless systems) that isolate or remove the bloodborne pathogens hazard from the workplace.

Exposure Incident: a specific eye, mouth, other mucous membrane, non-intact skin, or parenteral contact with blood or other potentially infectious materials that result from the performance of an employee's duties.

HBV: Hepatitis B Virus

HCV: Hepatitis C Virus

HIV: Human Immunodeficiency Virus

Parenteral: piercing mucous membranes or the skin barrier through such events as needle sticks, human bites, cuts and abrasions.

Personal Protective Equipment: specialized clothing or equipment worn by an employee for protection against a hazard. General work clothes (e.g., uniforms, pants, shirts or blouses) not intended to function as protection against a hazard are not considered to be personal protective equipment.

Potentially Infectious Materials:

(1) The following human body fluids: semen, vaginal secretions, cerebrospinal fluid, synovial fluid, pleural fluid, pericardial fluid, peritoneal fluid, amniotic fluid, saliva in dental procedures, any body fluid that is visibly contaminated with blood, and all body fluids in situations where it is difficult or impossible to differentiate between body fluids;

(2) Any unfixed tissue or organ (other than intact skin) from a human (living or dead); and

(3) HIV-containing cell or tissue cultures, organ cultures, and HIV- or HBV-containing culture medium or other solutions; and blood, organs, or other tissues from experimental animals infected with HIV or HBV.

Universal Precautions: a method of infection control in which all human blood and certain human body fluids are treated as if it is known that they are infected with bloodborne pathogens including, but not limited to, the Human Immunodeficiency Virus (H.I.V.), the Hepatitis B Virus (H.B.V.), and the Hepatitis C Virus (H.C.V.).

Work Practice Controls: controls that reduce the likelihood of exposure by altering the manner in which a task is performed.

HEPATITIS B IMMUNIZATION CONSENT/WAIVER FORM

[By law, the Hepatitis B vaccine series will be made available to employees within 10 days of initial assignment to a position presenting occupational exposure and completion of required training unless the employee has previously received the complete Hepatitis B series, antibody testing reveals the employee is immune, or the vaccine is contraindicated for medical reasons.]

Employee Name: _____

Position: _____ Site: _____

I understand that as part of my job, I may become exposed to blood or other potentially infectious items or materials that put me at risk for acquiring the Hepatitis B virus (HBV). Therefore, at no charge to myself, I have been offered the Hepatitis B vaccine, which is intended to render me immune to the HBV. At least three separate intramuscular injections are necessary to produce the desired immunity (sometimes additional injections are necessary to reach immunity), and all three doses are necessary in order for the vaccine to be effective. After the initial dose is given, repeat doses are given one month and six months later. There is a strong likelihood the vaccine will be successful if I receive all three doses, but there is a potential that even when administered properly the vaccine will not result in the desired immunity, such that there is a chance I may become infected with HBV even if I complete the full series.

All medicines may cause side effects, but most recipients of the vaccine have few or no side effects. The most commonly reported side effects include diarrhea, dizziness, fatigue, a general feeling of discomfort, headache, irritability, loss of appetite, mild fever or sore throat, nausea, pain, swelling, or redness at the injection site, runny nose, tiredness, weakness. In rare cases, more severe side effects may occur, including rash, hives, itching, difficulty breathing, tightness in the chest, swelling of the mouth, face, lips, or tongue, unusual hoarseness, fainting, fast or irregular heartbeat, red, swollen, blistered, or peeling skin, severe or persistent dizziness, unusual bruising or bleeding. In case of such reactions, seek immediate medical care or attention.

If the vaccine does not lead to the desired immunity (because I do not complete the three-dose series, or I choose not to receive supplemental injections if the first series does not develop immunity), or if I choose not to receive the vaccine at this time, I understand that I will need post-exposure treatment if I have a direct contact with blood, other body fluids, or other actually or potentially infected items, in order to address potential exposure concerns.

- YES I WANT THE VACCINE** - I have read and understand the above information and wish to receive the hepatitis B vaccine series (three doses). I have no known sensitivity to yeast and I am unaware of any reason why the vaccine may cause me harm or lead to an adverse reaction.
- NO - I DECLINE THE VACCINE.** -I have read and understand the information above. I understand that due to my occupational exposure to blood or other potentially infectious materials I may be at risk of acquiring hepatitis B virus (HBV) infection. I have been given the opportunity to be vaccinated with hepatitis B vaccine, at no charge to myself. However, I decline hepatitis B vaccination at this time. I understand that by declining this vaccine, I continue to be at risk of acquiring hepatitis B, a serious disease. If in the future I continue to have occupational exposure to blood or other potentially infectious materials and I want to be vaccinated with hepatitis B vaccine, I can receive the vaccination series at no charge to me.

Date: _____

Signature: _____

Section 12	Safe Work Practices	
12.1	Safe Work Practices	Effective Date: 1/1/2018 <i>Revised: 2/28/21</i>
12.1.1 Purpose	1. This section provides information regarding Safe Work Practices (in previous safety manual revisions the term High-risk tasks was used). The Company will develop Safe Work Practices (SWP) as necessary to ensure safety is the primary consideration for work that typically involves a higher level of risk and or complexity. Creating and using Safe Work Practices should also improve consistency and quality of work.	
12.1.2 Responsibilities	<ol style="list-style-type: none"> 1. The Company will utilize internal and external subject matter experts to create SWPs. 2. It is the Company's responsibility to communicate and train employees on SWP's. 3. SWPs will be reviewed and approved by the Safety Dept. 	
12.1.3 Requirements	<ol style="list-style-type: none"> 1. The SWPs will be maintained and accessed on the Grid 2. SWPs will be revised as needed. Notifications will be sent out when modifications or new SWPs are posted on the Grid. 	
12.1.4 Risk Identification	<ol style="list-style-type: none"> 1. Employee personal injury or property damage 2. Inconsistent work quality 	
12.1.5 Safe Work Practices	<ol style="list-style-type: none"> 1. The following links are the current approved Safe Work Practices. These are available to review at Versant Power Line & Meter Ops web page <ol style="list-style-type: none"> 2.01 Megger Insulation Testing.pdf 2.02 Fault Wizard Instructions.pdf 2.03 V-Watch rev 8 7 18 2.04 Phasing Sticks – Rev 1 2.05 Break Safe 2.06 Protective Grounding Equipment 2.07 Fall Protection 2.09 Power Tool Inspection, Maintenance, and Use 3.01 Use & Placement of Wheel Chocks 3.02 Load Securement 3.03 Bucket Truck Boom Washing 3.04 Fiberglass Boom & Bucket Liner Testing 3.05 Slings 3.06 Hoists 5.01 4 ft Shotgun Sticks.pdf 5.02 Insulating Protective Equipment – Rev 1 5.03 Equipotential Grounding – Rev 2 5.04 Setting Poles in Energized Conductors 3.22.19 5.05 Insulating Web Strap Hoists 	

	<ul style="list-style-type: none"> 5.06 Line Voltage Regulator Installation R1 5.07 Paralleling Distribution Transformers 5.08 Use of Rated Mechanical Jumpers 5.09 Energized Cutout Change Out 5.10 Capacitors <u>R1</u> 5.11 Cut Double Deadend in Existing Primary – Rev1 5.12 AR Clothing 5.13 Hot Stick 34.5 – 46kV 5.14 Transformer Installation-Removal R1 5.15 Composite Utility Poles 5.16 FRP Protective Equipment 5.17 Repairing Disconnect on Energized Bus 5.18 Make Safe Work 5.19 Conductor Installation-Removal R1 5.20 Hendrix Conductor – Rev 1 5.21 Replacing Broken Utility Poles 5.22 <i>Isolated Not Grounded (ING)</i> 5.23 Securing Low Conductors 6.01 Motor Operated Switches 6.02 Switching Metal Clad Breaker Devices 7.01 Transmission Pole Removal (MITC-FUME)
12.5.6 Definitions	